

1/35 MILITARY MINIATURE VEHICLE UPGRADE SERIES PE35360







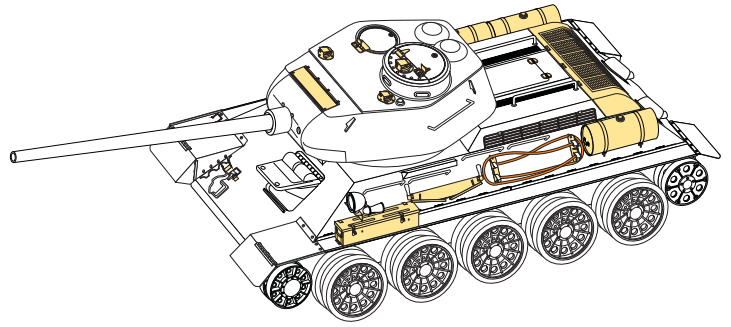
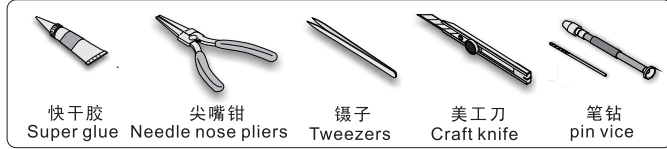

WWII Russian T-34/85

二战苏联T-34/85 改造件

[For AFV CLUB 35145]

推荐使用工具 RECOMMENDED TOOLS



- 
安装
install
- 
折叠
bend
- A1**
改造件零件编号
PE/resin part number
- B12**
原零件编号
kit part number
- C22**
被替换的原零件编号
replaced kit part number
- 
 另一侧相同制作
repeat on opposite side
- 
切除
remove
- 
注意
caution
- 
弧度卷曲
radial bending
- x2**
制作若干组
multiple assembly
- 
选择安装
alternative
- 
用铜管制作
make from brass tube
- 
用胶棒制作
make from plastic rod

 用尖端在凹槽处冲压
use penpoint to press on the dent

蚀刻片零件内面向上
Put the part upside down
 用笔尖在凹槽处刻
Use penpoint to press on the dent

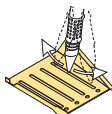
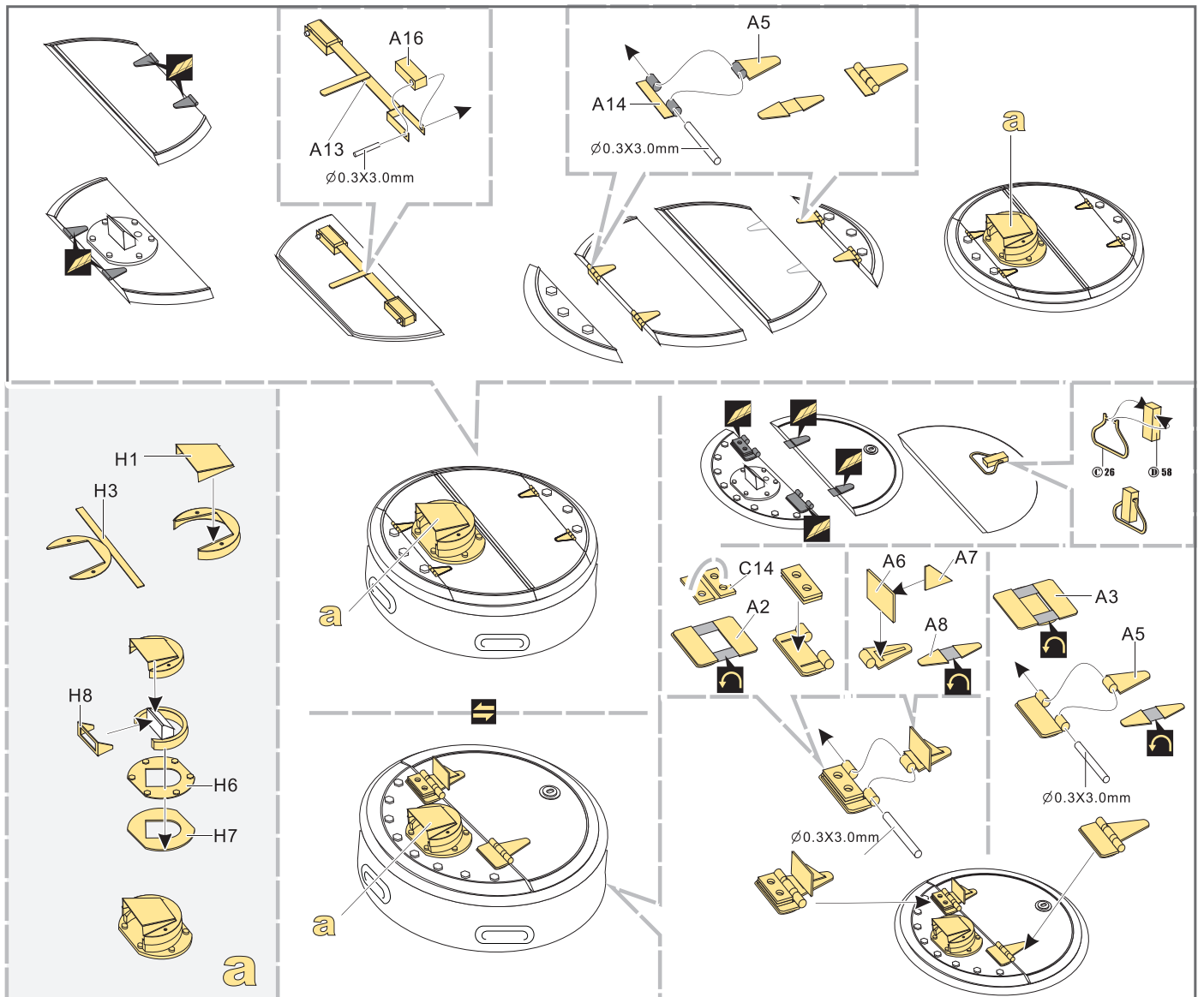
1/35 MILITARY MINIATURE VEHICLE UPGRADE SERIES PE35360

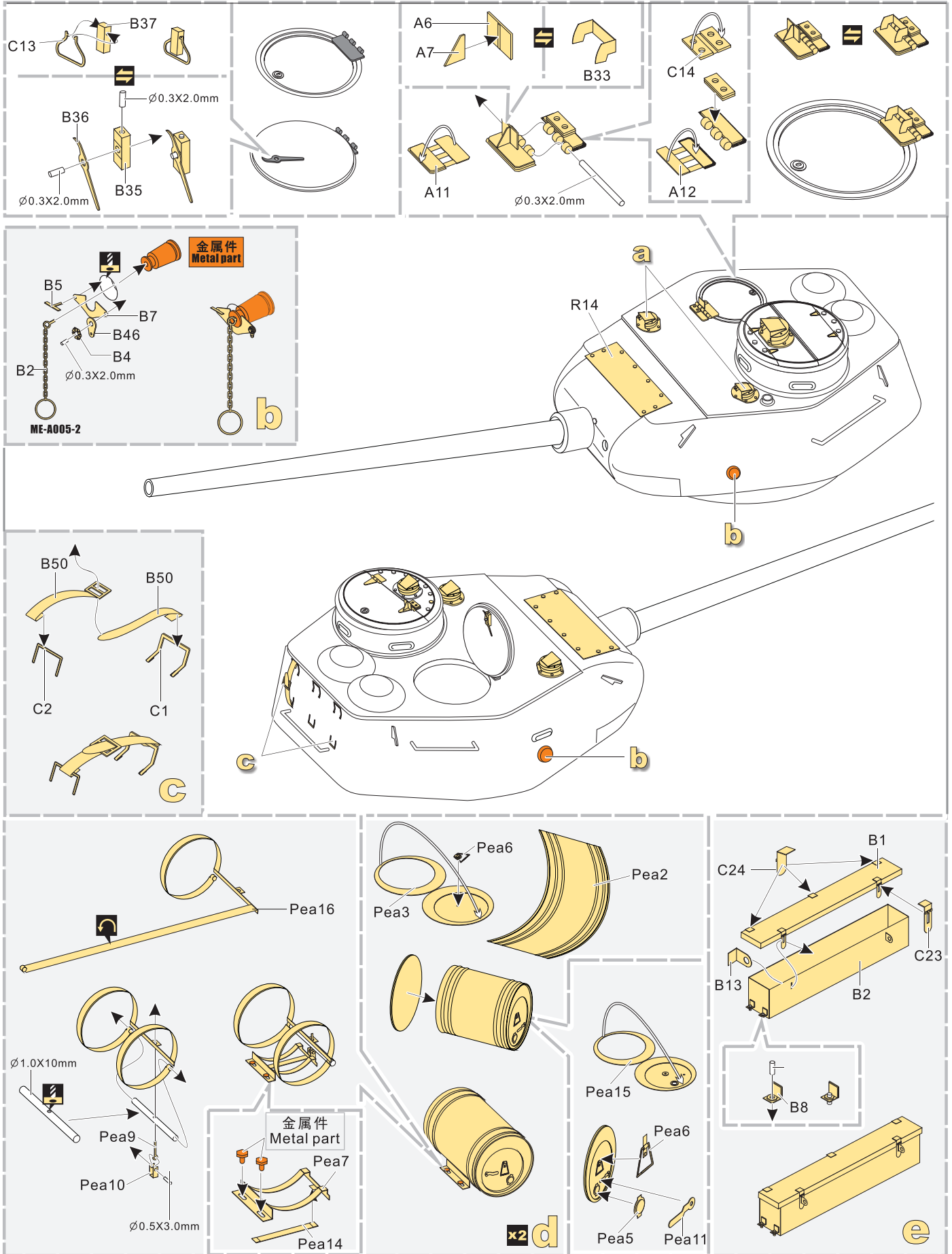

1/35 MILITARY MINIATURE VEHICLE UPGRADE SERIES PE35360

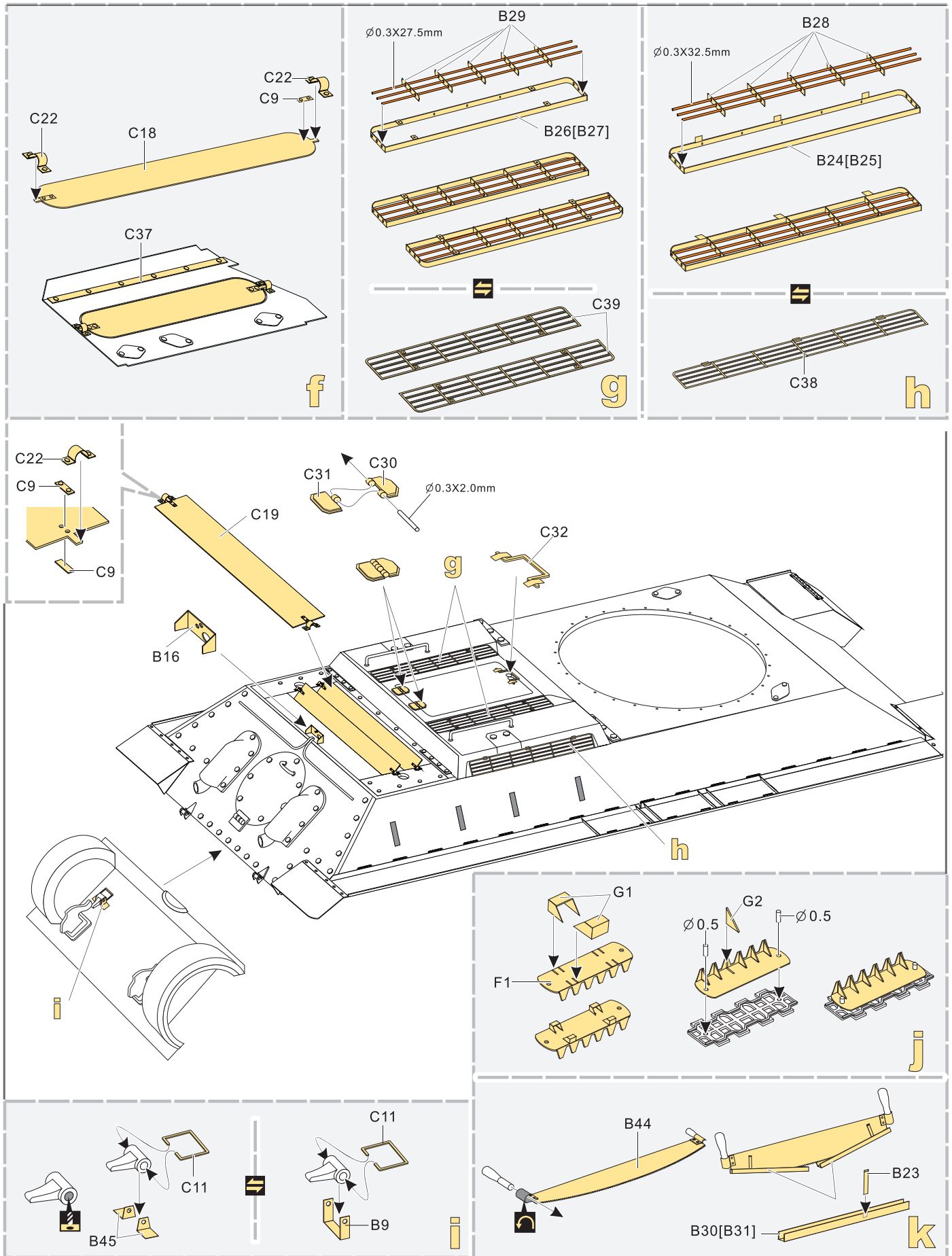

1/35 MILITARY MINIATURE VEHICLE UPGRADE SERIES PE35360

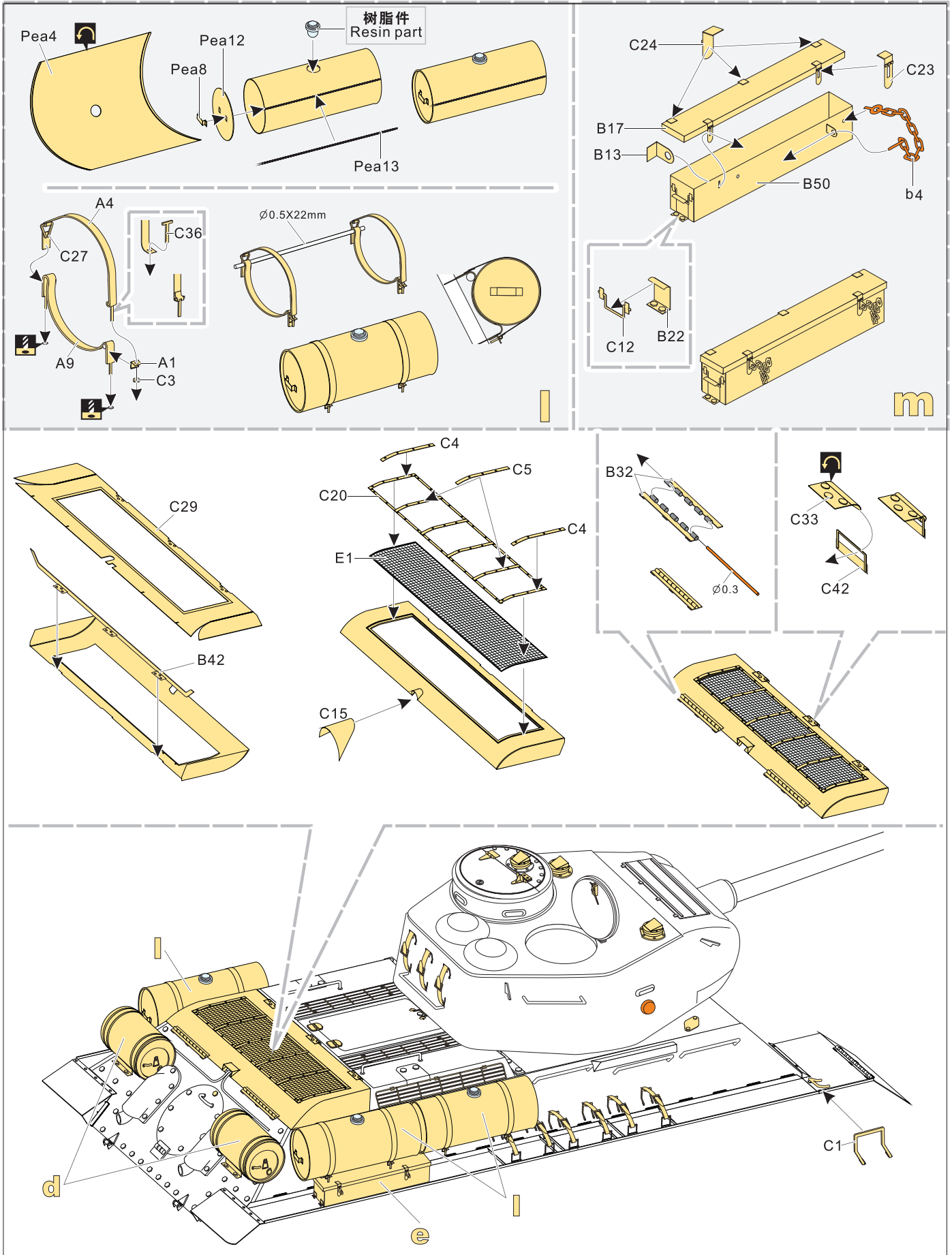

1/35 MILITARY MINIATURE VEHICLE UPGRADE SERIES PE35360

