

EagleCals

EC#67

1/72

1/48 1/32

GRAF & GRISLAWSKI

eagle

EDITIONS LTD.

Part 4

Bf 109 G-2

Obfw. Alfred Grislawski, 9./JG 52

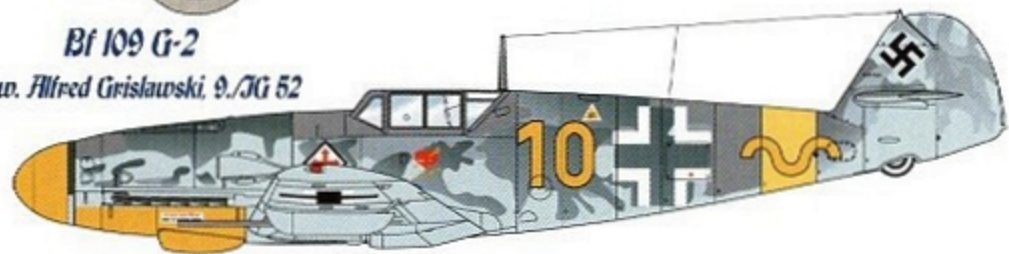

Bf 109 G-4

Lt. Alfred Grislawski, 7./JG 52

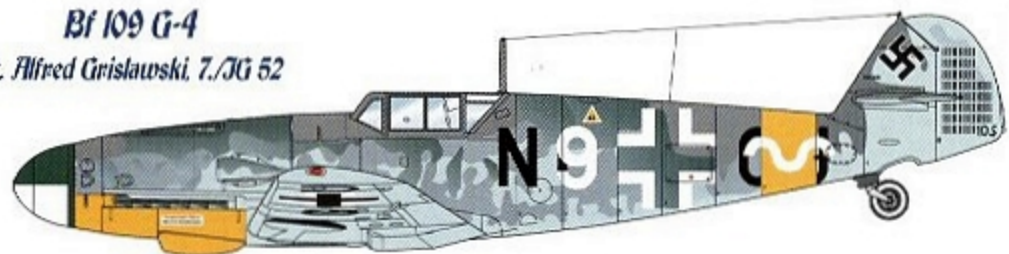

Bf 109 G-6

Obstlt. Hermann Graf, Stab./JG 52

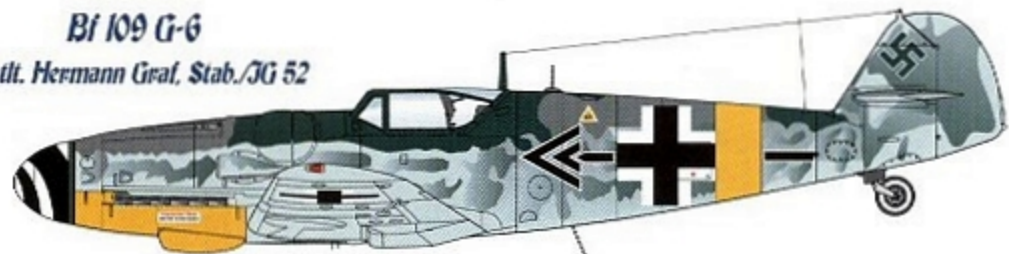

Bf 109 G-5

Obstlt. Hermann Graf, Stab./JG II

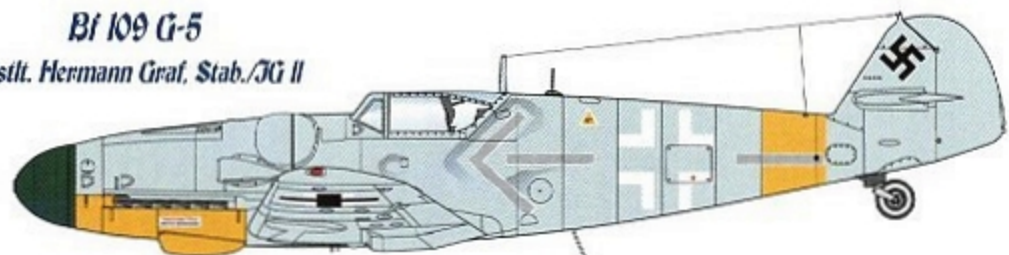



E



1010

F



G

H



9^K N^J 9^O

NIGU
NIGU

K L M N



T



U

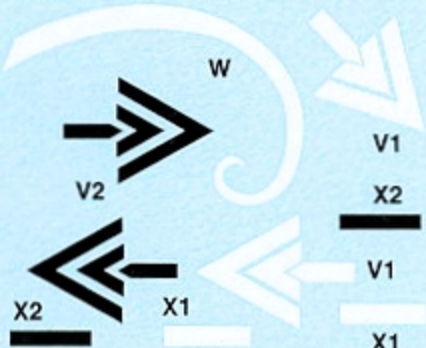

B

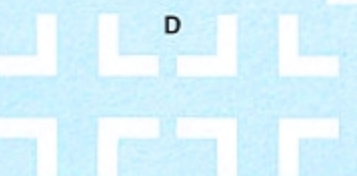

D



A



B

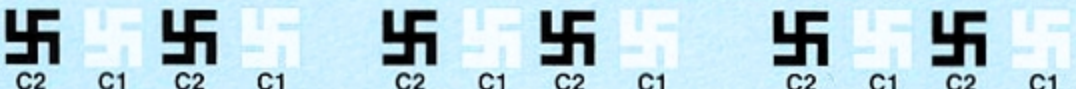
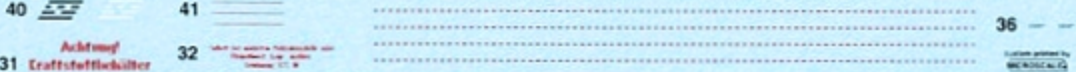
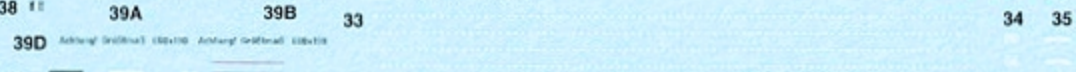
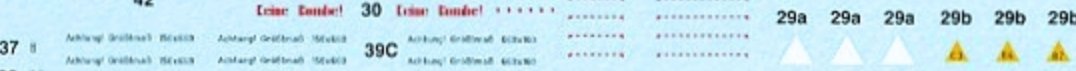
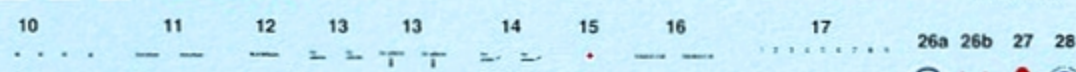
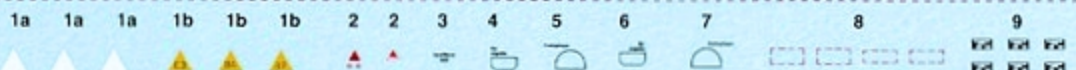
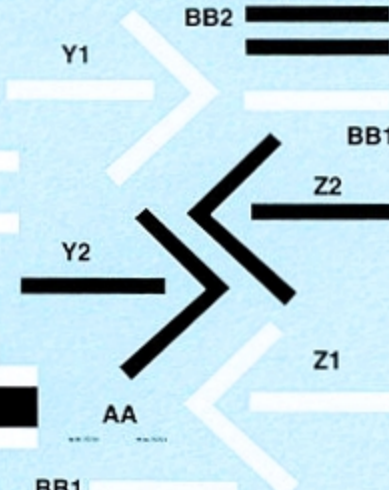

C2 C1 C2 C1 C2 C1 C2 C1 C2 C1 C2 C1

Yellow 10

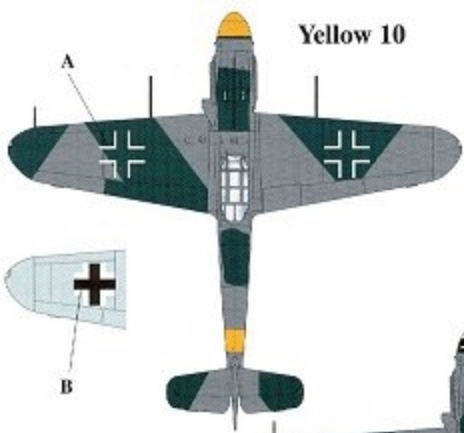

White 9

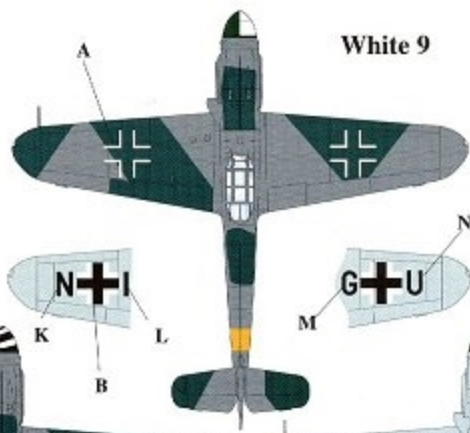

Black <-

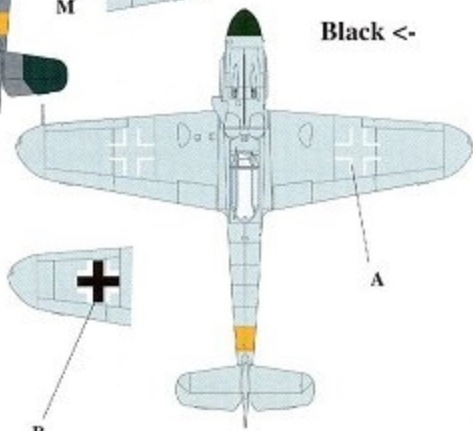
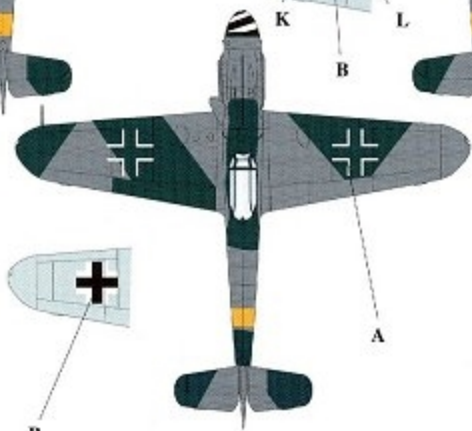

Black <<-

B

B

EagleCals # 67

Graf & Grislawski Part 4

This is the fourth in a series of four decal sheets depicting the colorful aircraft flown by the Luftwaffe fighter *Experten* Hermann Graf and Alfred Grislawski. Additional details can be found in the book *Graf & Grislawski, A Pair of Aces* ISBN 0972106049 by Christer Bergstrom and Claes Sundin, 2003 Eagle Editions Ltd. Montana USA. This title is available from Eagle Editions, your local hobby shop or book store. Instructional text written by Mark Proulx. For accurate color we recommend using the *Official Luftwaffe Color Chart* by Wernecke and Böhm, available from Eagle Editions or your local hobby shop.

"Yellow 10"	Bf 109 G-2	W.Nr. 13482	9/JG 52	Sept. 1942	USSR
-------------	------------	-------------	---------	------------	------

Pilot: Obfw. Alfred Grislawski. This aircraft was flown from 17 July to 21 Sept 1942 at Gonstakovka, USSR. He would claim 8 confirmed victories in this aircraft. *Staffel* emblem under cockpit with fiancé's name "Ilse" in white.

Colors: Undersurfaces RLM 76 Light Blue. Uppersurfaces: RLM 74 Gray-Violet/RLM 75 Gray-Green mottled on fuselage. Lower cowlings, spinner and *Gruppe* band: RLM 04 Yellow. Spinner backplate: RLM 70 Black-Green and White. Prop blades: RLM 70 Black-Green.

National Markings: Fuselage: B5 style 900mm White outline crosses.
Upper Wings: Upper: B6 style 1000mm White outline crosses.
Lower Wings: B3 style 900mm Black/White crosses.
Hakenkreuz: H2a 300mm Black with White outline.

Stenciling: Factory standard.

"White 9"	Bf 109 G-4	W.Nr. 19451	9/JG 52	May 1943	USSR
-----------	------------	-------------	---------	----------	------

Pilot: Lt. Alfred Grislawski. Flown from Taman in the USSR, 28 May 1943. He would fly this aircraft from 29 April to 23 June 1943 claiming 9 confirmed victories. White 9 applied over fuselage *Stammkennzeichen*.

Colors: Undersurfaces RLM 76 Light Blue. Uppersurfaces: RLM 74 Gray-Violet/RLM 75 Gray-Green mottled on fuselage. Lower cowlings and *Gruppe* band: RLM 04 Yellow. Spinner and backplate: RLM 70 Black-Green and White. Prop blades: RLM 70 Black-Green.

National Markings: Fuselage: B5 style 900mm White outline crosses.
Upper Wings: B6 style 1000mm White outline crosses.
Lower Wings: B3 style 900mm Black/White crosses.
Hakenkreuz: H2a 300mm Black with White outline.

Stenciling: Factory standard. *Stammkennzeichen* still visible under wings.

"Chevron Bar"	Bf 109 G-6	W.Nr. Unknown	Stab./JG 52	Sept. 1944	Poland
---------------	------------	---------------	-------------	------------	--------

Pilot: Obstlt. Hermann Graf (provisional). *Erla-Haube* canopy fitted. Flown from Krakow, Poland late Sept 1944. The aircraft was likely handed over by the earlier Kommodore, Dietrich Hrabak, upon his return to Germany.

Colors: Undersurfaces RLM 76 Light Blue. Uppersurfaces: RLM 74 Gray-Violet/RLM 75 Gray-Green heavily mottled on fuselage. Lower cowlings and *Gruppe* band: RLM 04 Yellow. Spinner: Black with White spiral. Spinner backplate: RLM 70 Black-Green and White. Prop blades: RLM 70 Black-Green.

National Markings: Fuselage: B3 style 900mm Black/White crosses.
Upper Wings: B6 style 1000mm White outline crosses.
Lower Wings: B3 style 900mm Black/White crosses.
Hakenkreuz: H2a 300mm Black with White outline.

Stenciling: Factory standard.

"Chevron Bar"	Bf 109 G-6	W.Nr. 15729	Stab./JG 11	March 1944	Germany
---------------	------------	-------------	-------------	------------	---------

Pilot: Obstlt. Hermann Graf. *Erla-Haube* canopy fitted. This aircraft was flown from Rotenburg, Germany in March 1944. Note fuselage markings lightly oversprayed in a high altitude scheme of RLM 76; the underlying scheme is 74/75/76, provisional. Originally a G-5 but converted to a G-6.

Colors: Undersurfaces RLM 76 Light Blue. Uppersurfaces: Extensively oversprayed in high altitude scheme using RLM 76 Light Blue. Lower cowlings and *Gruppe* band: RLM 04 Yellow.
Spinner and prop blades: RLM 70 Black-Green.

National Markings: Fuselage: B5 style 900mm White crosses with very light overspray.
Upper Wings: B6 style 1000mm White outline crosses.
Lower Wings: B3 style 900mm Black/White crosses.
Hakenkreuz: H2a 300mm Black with White outline.

Stenciling: Likely oversprayed by RLM 76 Light Blue.