



1/350  
Detail UP  
Set

# HMS Cornwall 1942

## VF350024



### CNC Scribed Brass Part:

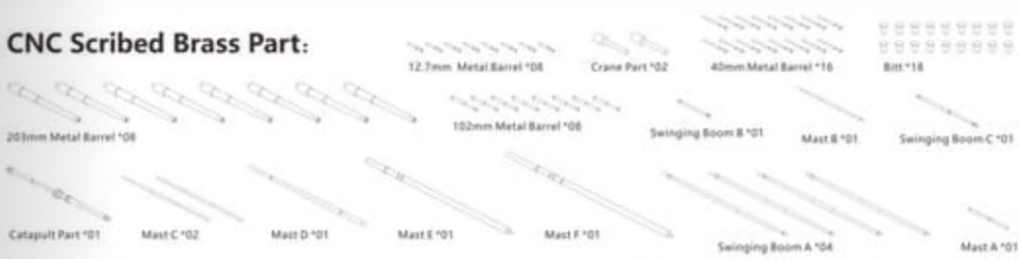

### Wooden Deck:

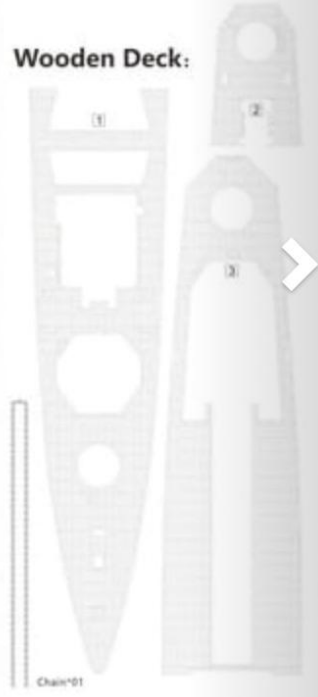

### Resin Part:

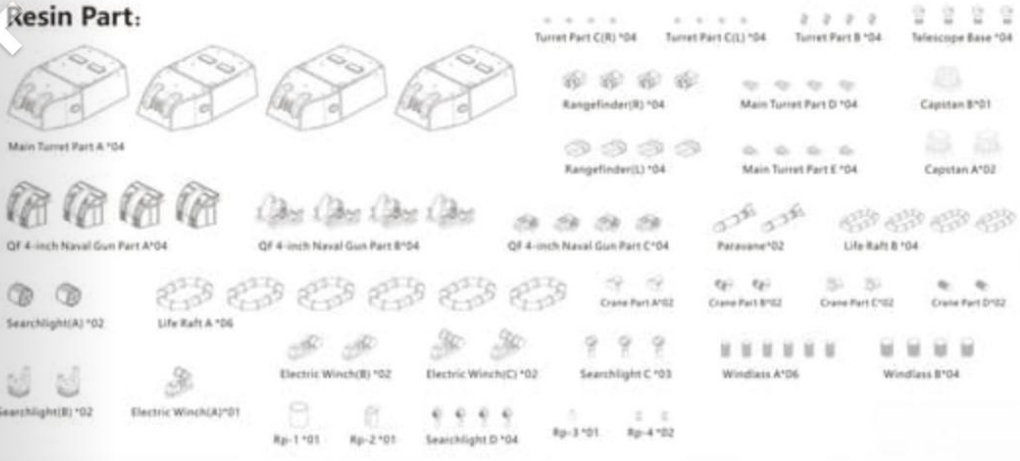

### Photo Etching:

A, B, C, D, E, F, G, H (Total : 8 Sheets)

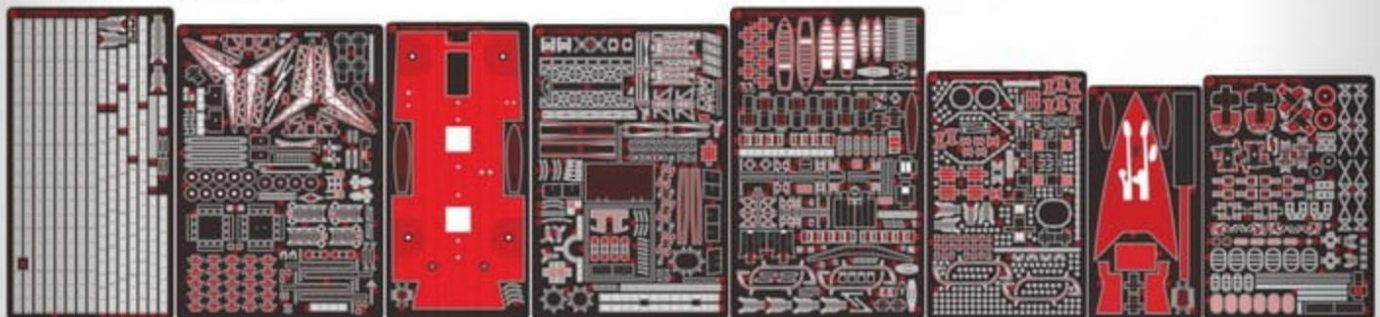



# 1/350 HMS Heavy Cruiser Cornwall 1942 Detail Up Set

NO.VF350024

## CNC Scribed Brass Part:

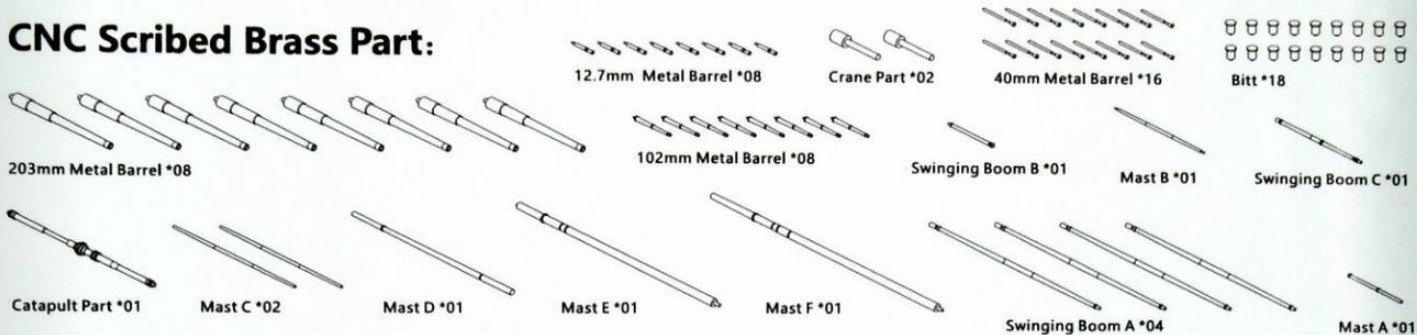

## Resin Part:

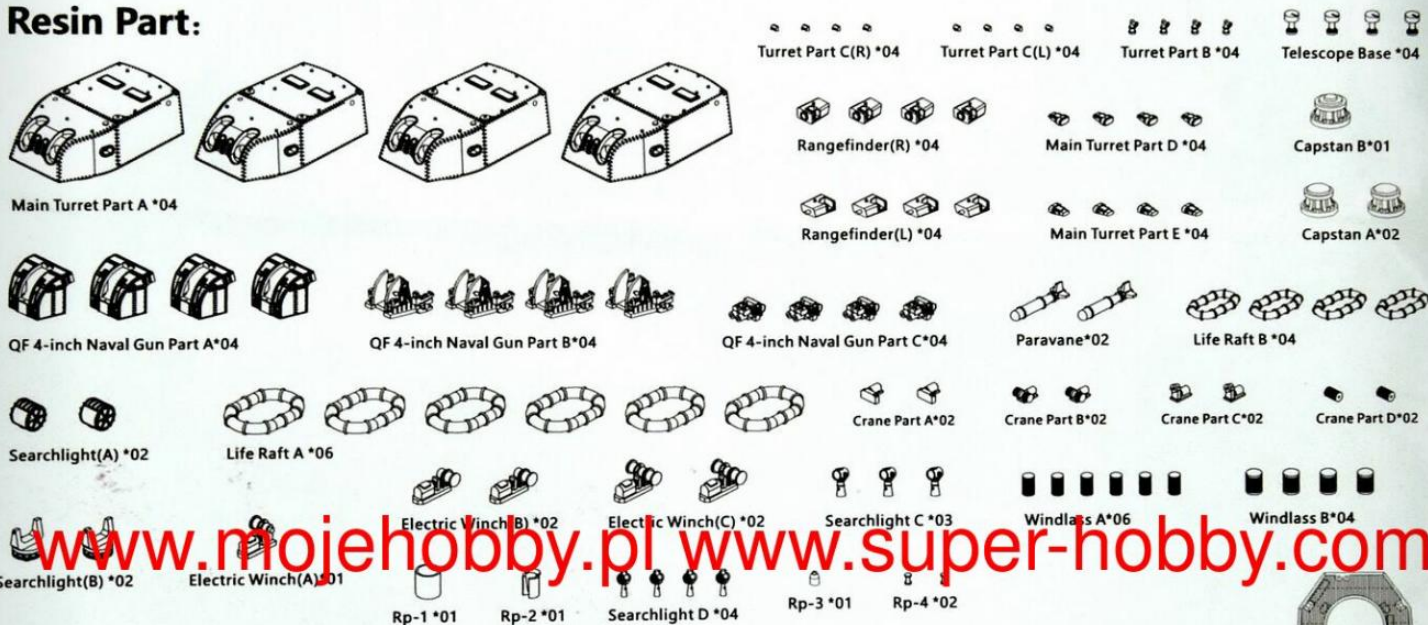

## Photo Etching:

A, B, C, D, E, F, G, H (Total : 8 Sheets)

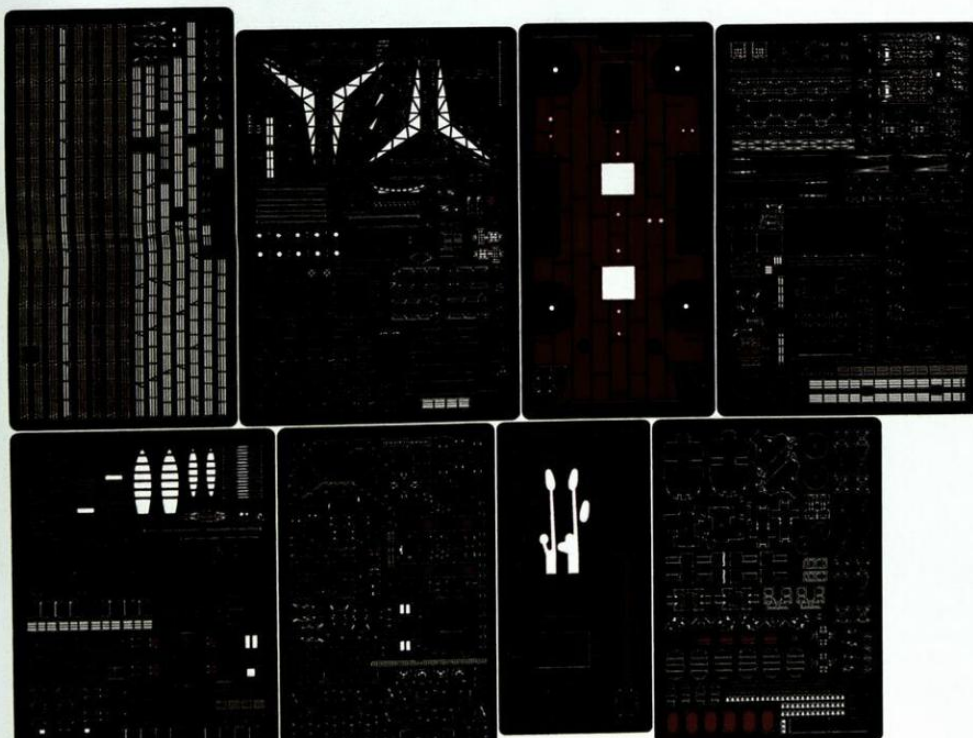

## Wooden Deck:

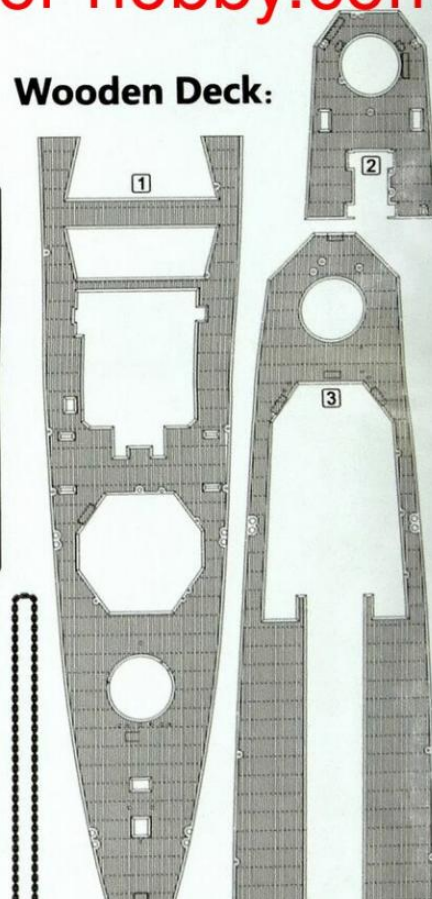

[www.moje Hobby.pl](http://www.moje Hobby.pl) [www.super-hobby.com](http://www.super-hobby.com)



- Install 组装
- Remove 去除
- Bend 弯曲
- Make Hole 钻孔
- Same Another Side 对侧相同
- Up Fold 向上折
- Down Fold 向下折

### Vickers 0.5-inch Antiaircraft Machineguns

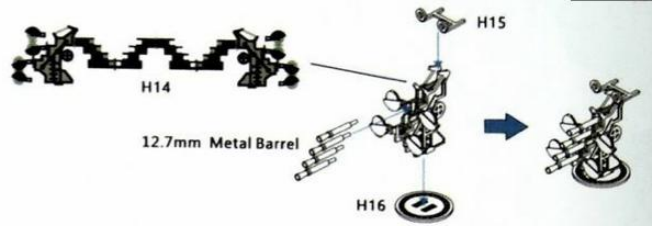

### BL L/50 Mark VIII Main Gun

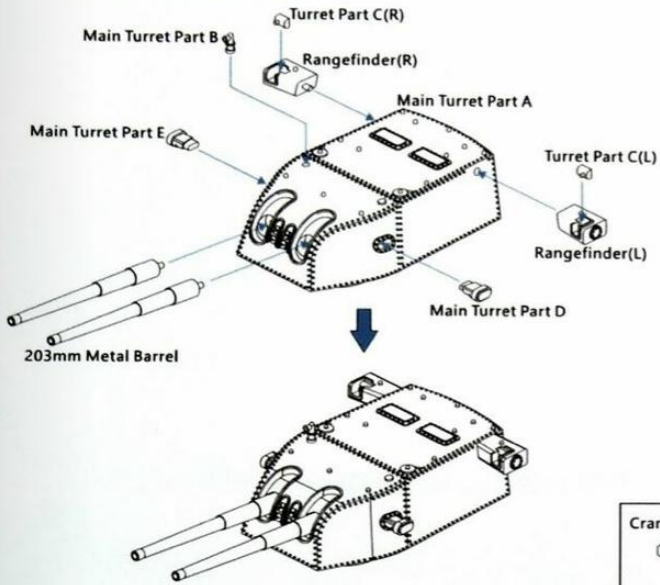

### QF 4-inch MK V Naval Gun

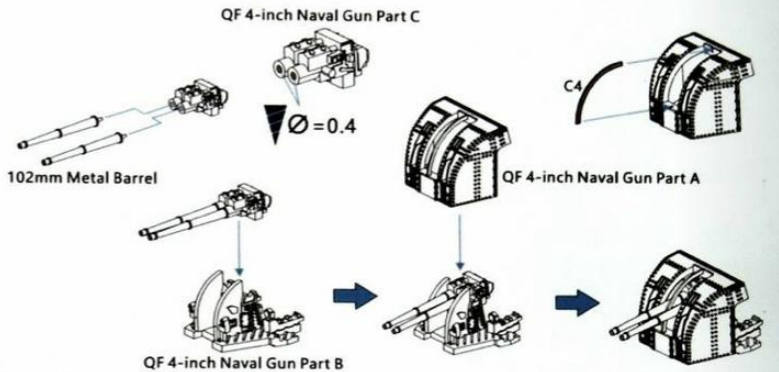

### Crane

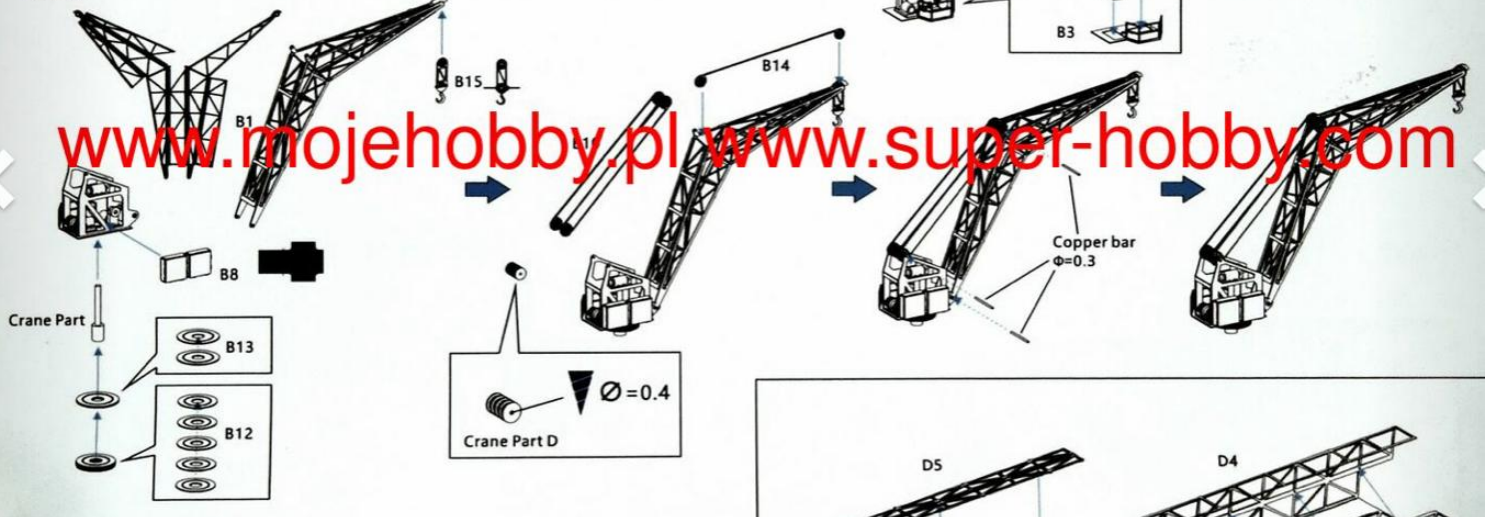

### Catapult

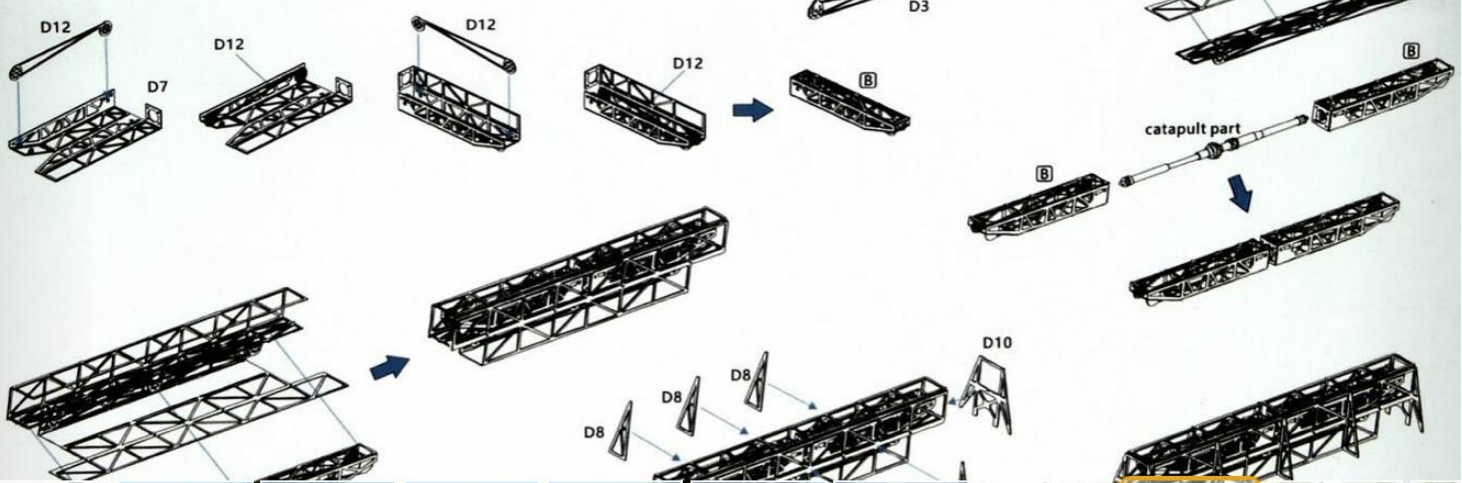

[www.mojehobby.pl](http://www.mojehobby.pl) [www.super-hobby.com](http://www.super-hobby.com)





Kit D

Kit D

Kit Deck

Kit Deck

Kit D

Kit D

Kit A11

Kit F3

Kit A27

Kit F5

Kit A6+A7

Kit B8+B9

Kit F1

Kit F3

Kit F2

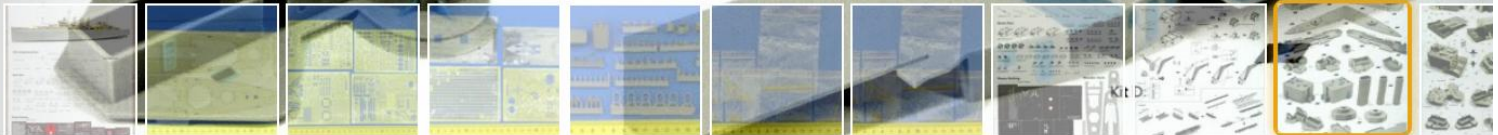



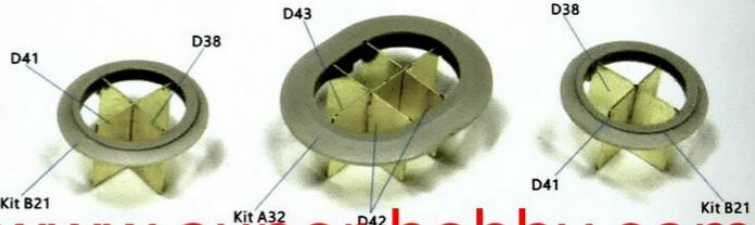
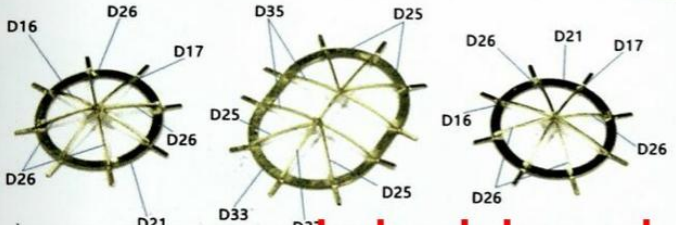
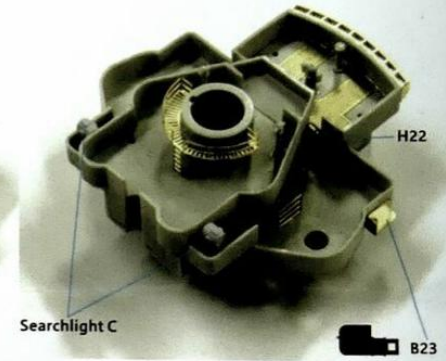
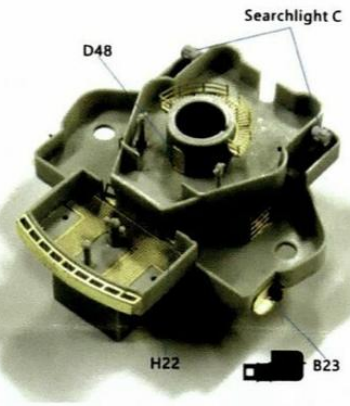
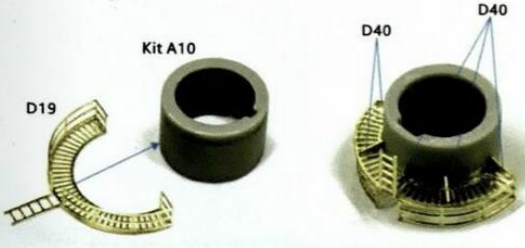
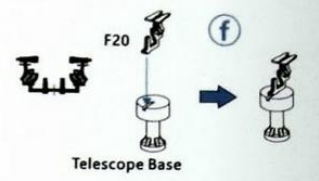
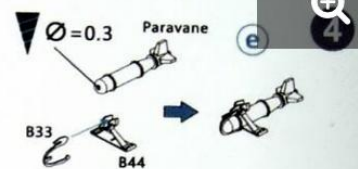
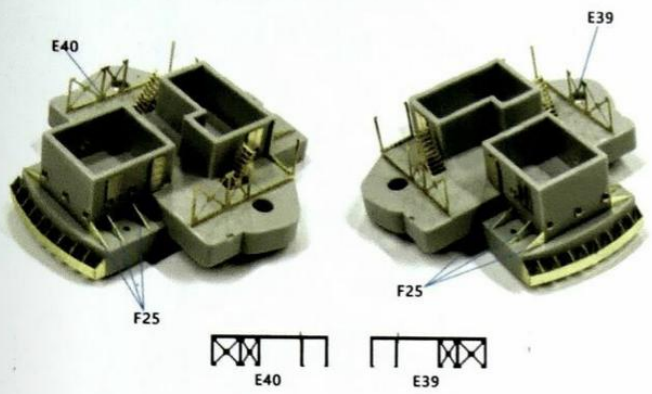

www.moje hobby.pl www.super-hobby.com

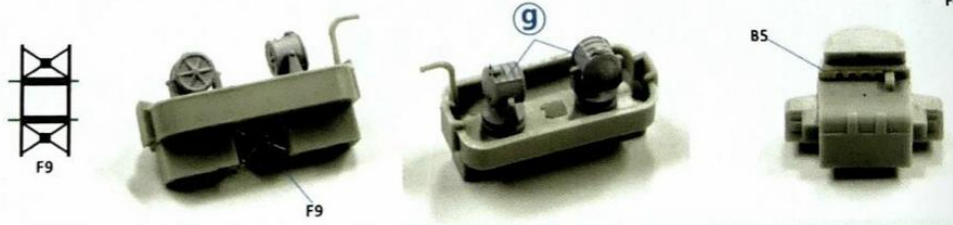
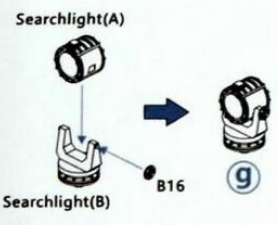
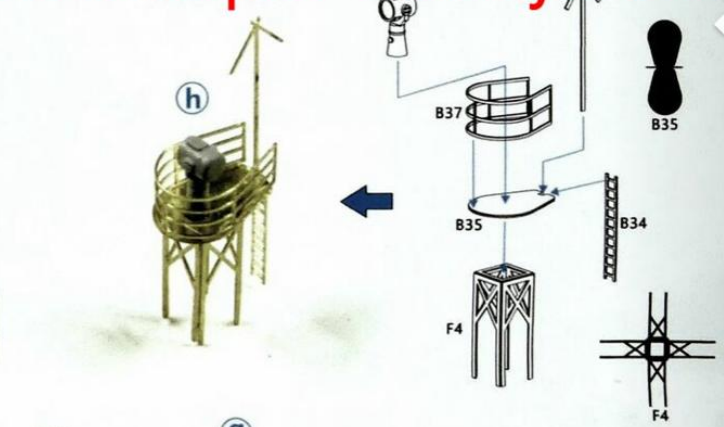

### Supermarine Walrus Mk.I



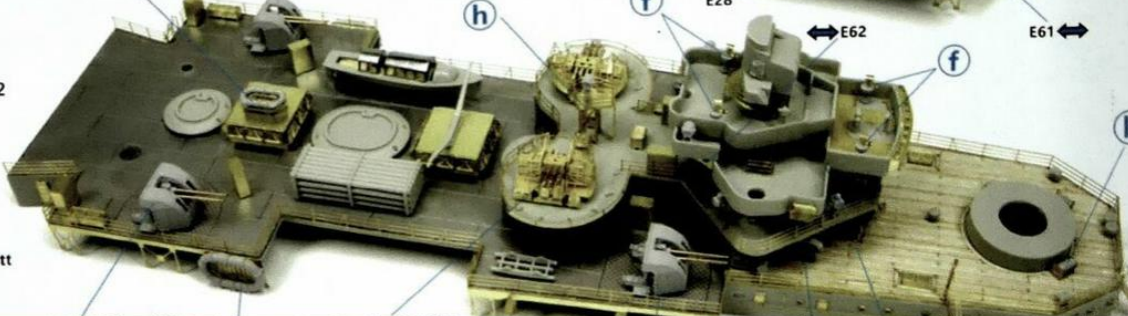
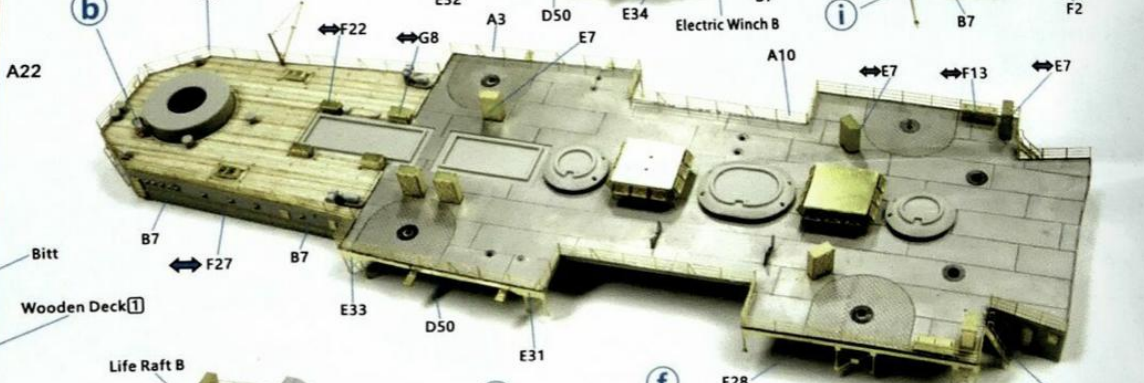
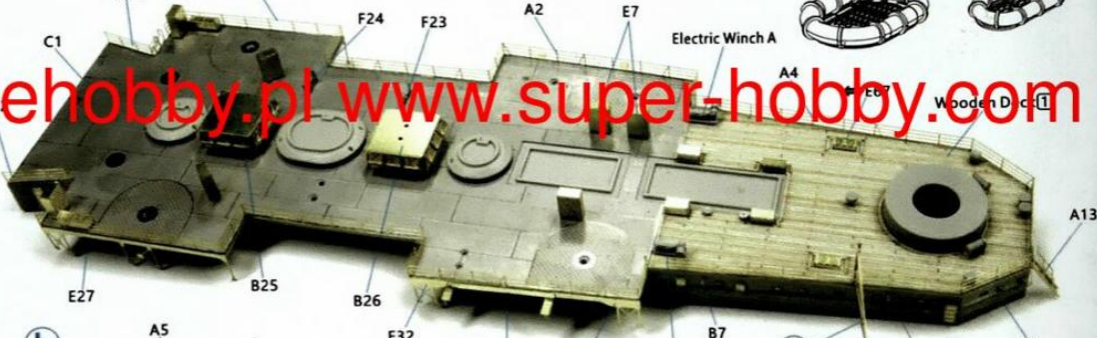
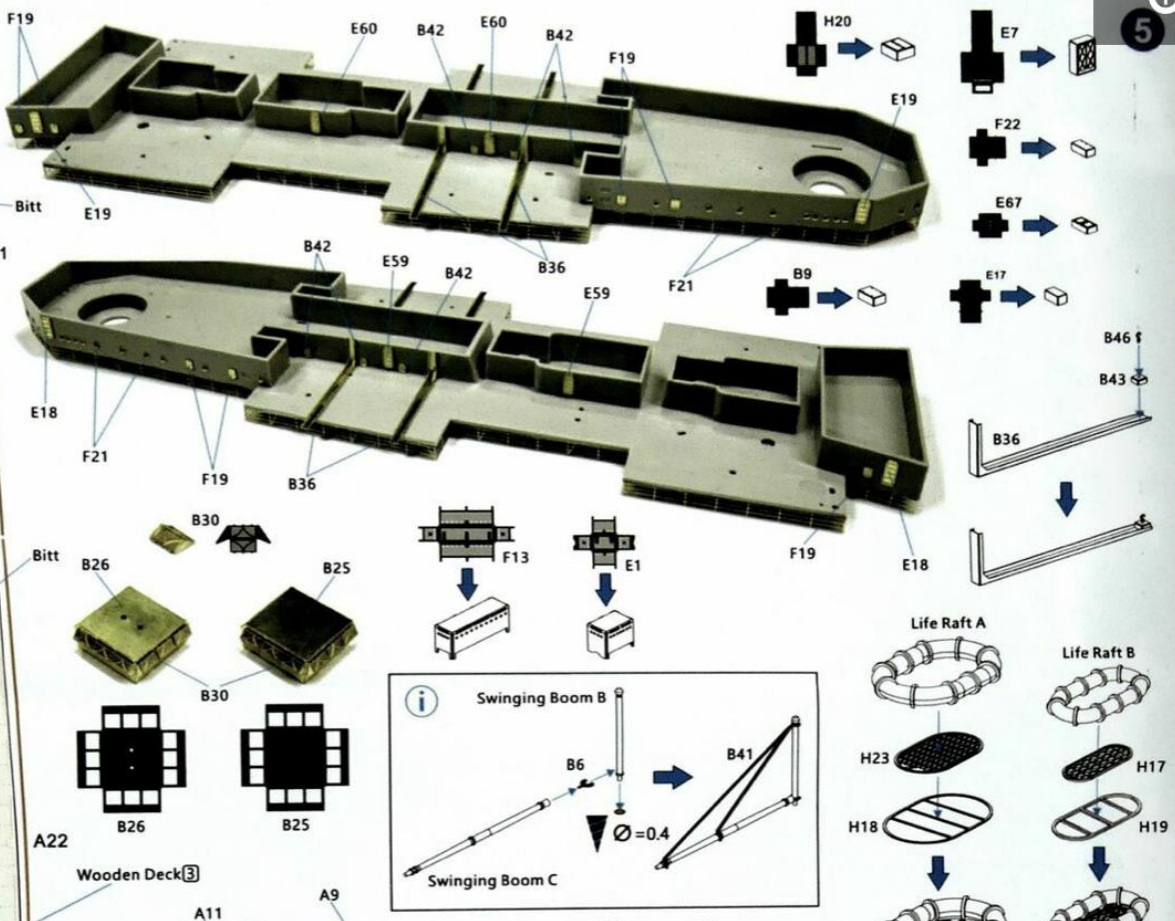

[www.mojeobby.pl](http://www.mojeobby.pl) [www.super-hobby.com](http://www.super-hobby.com)



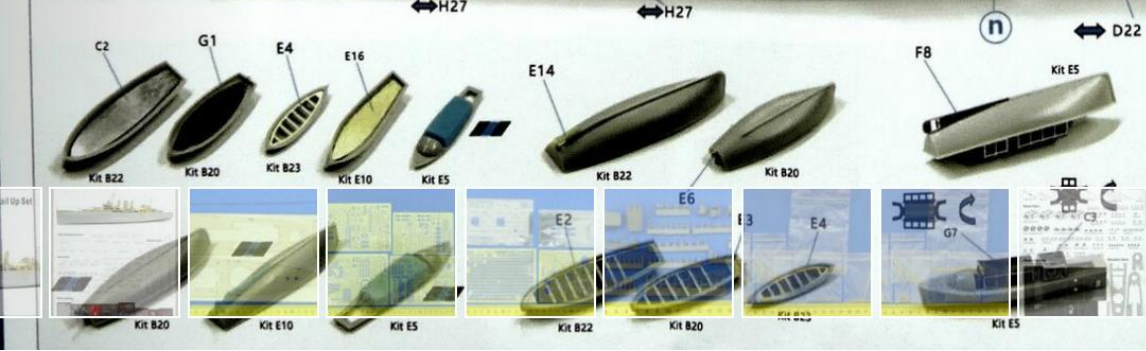
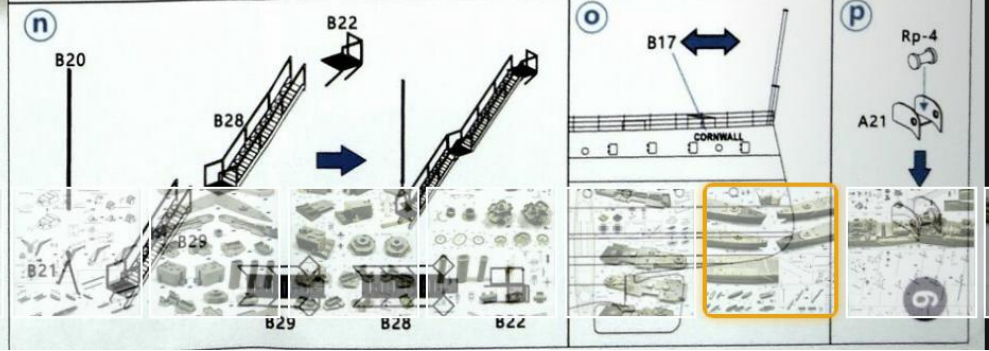
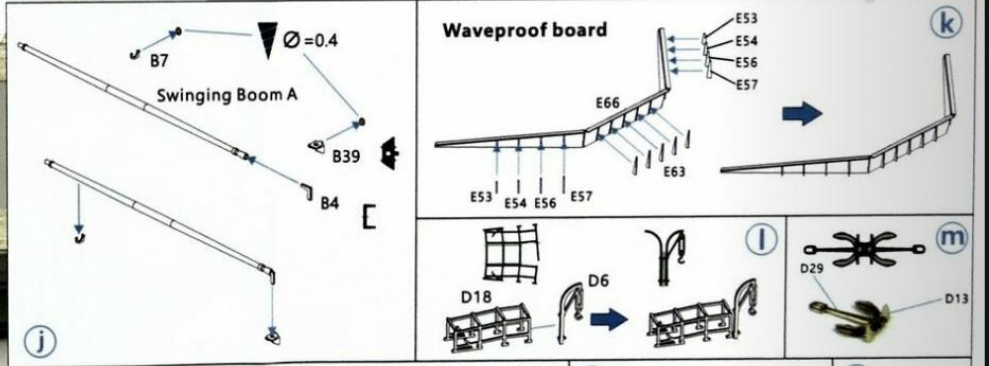
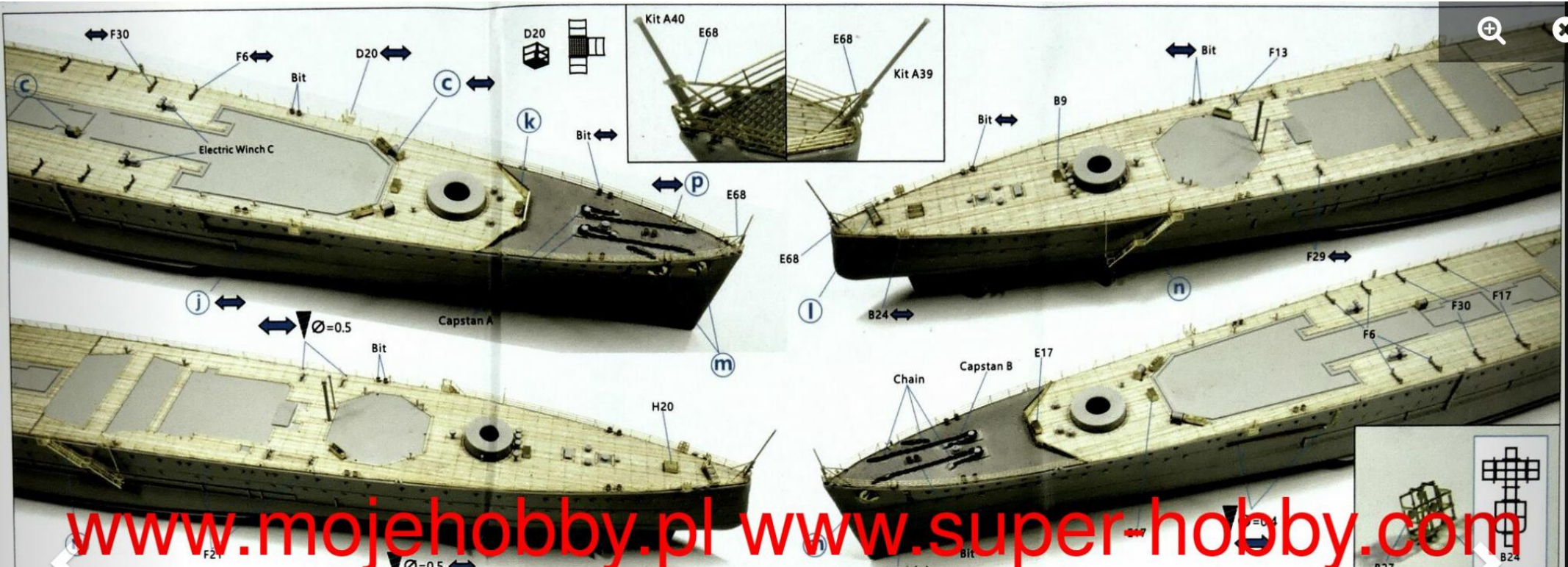



### British 40mm Pom-pom Mounting

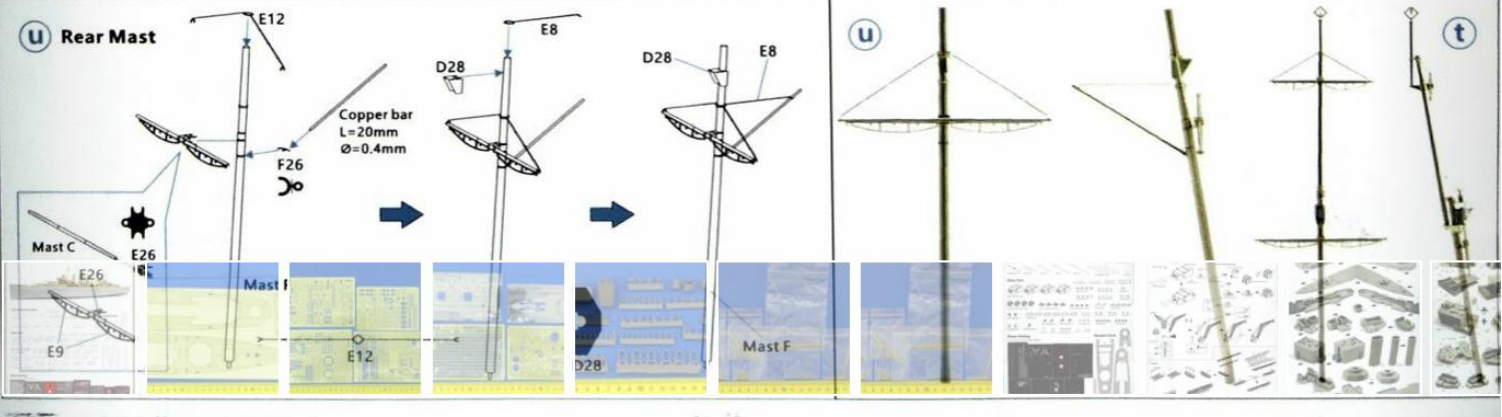
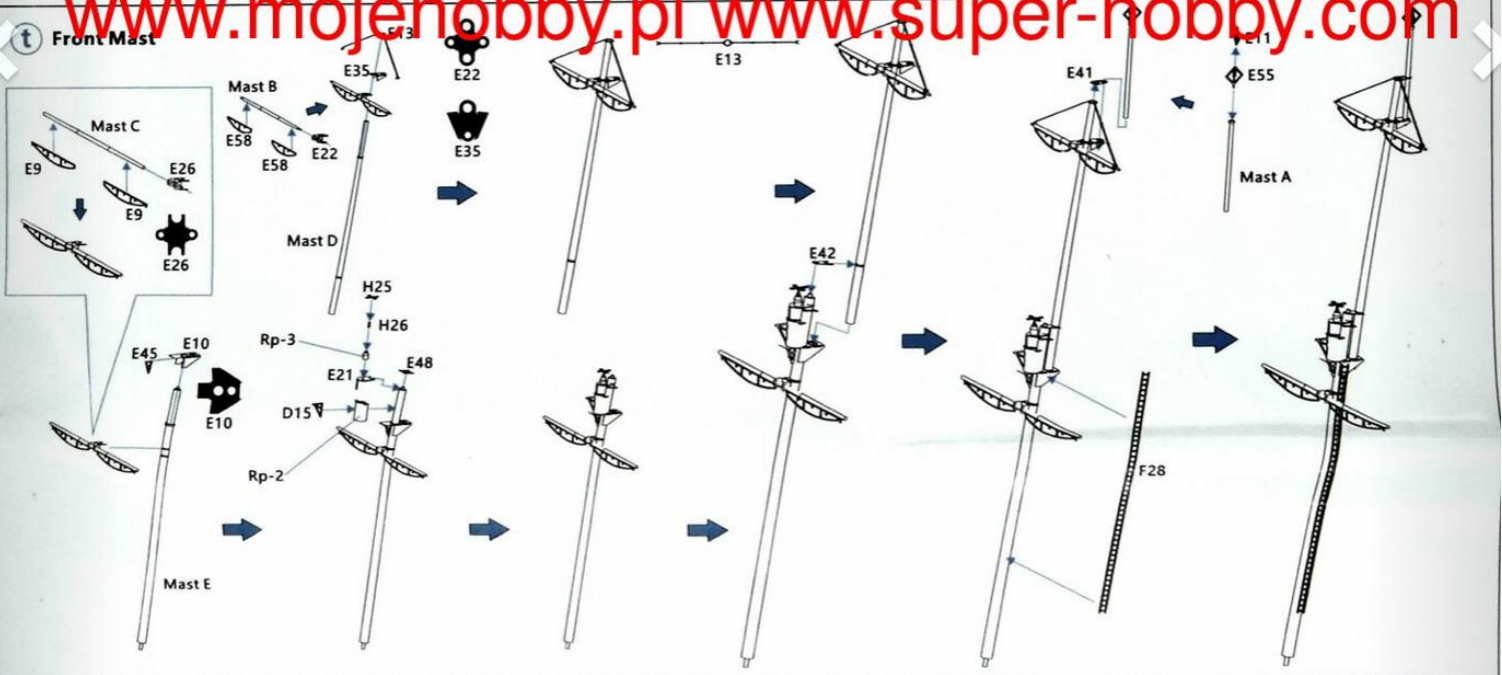
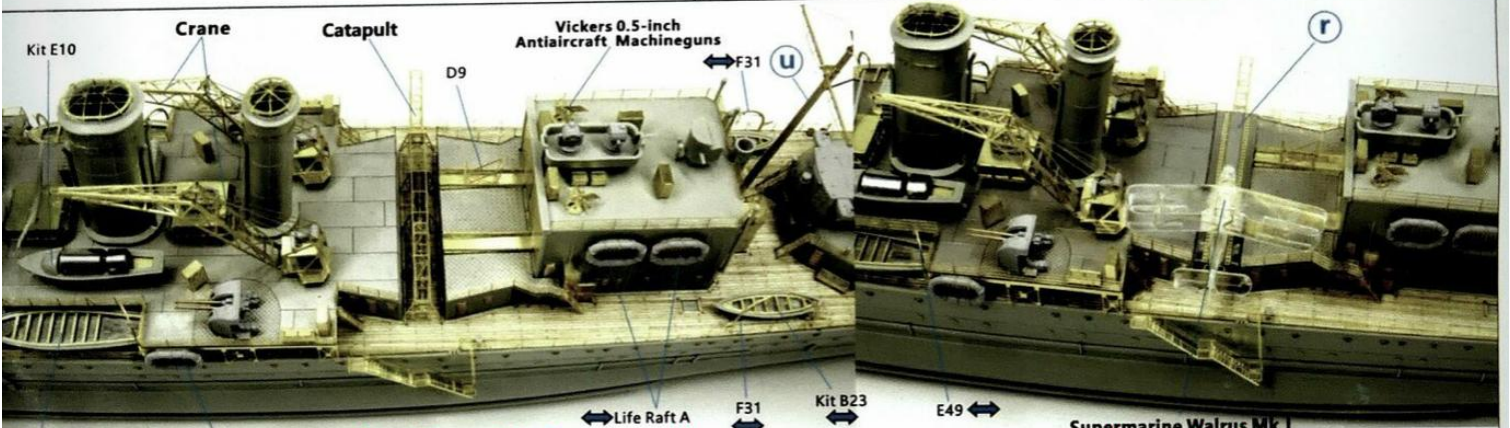
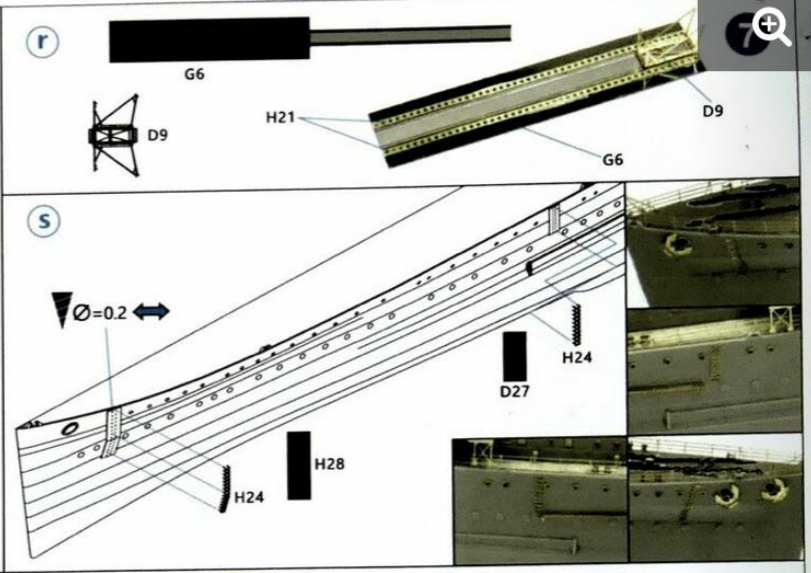
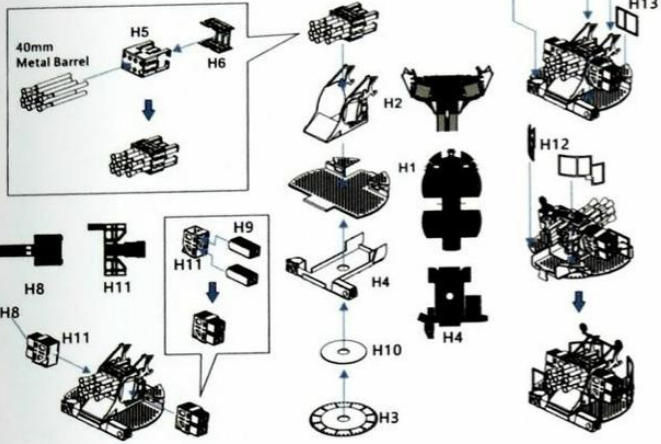

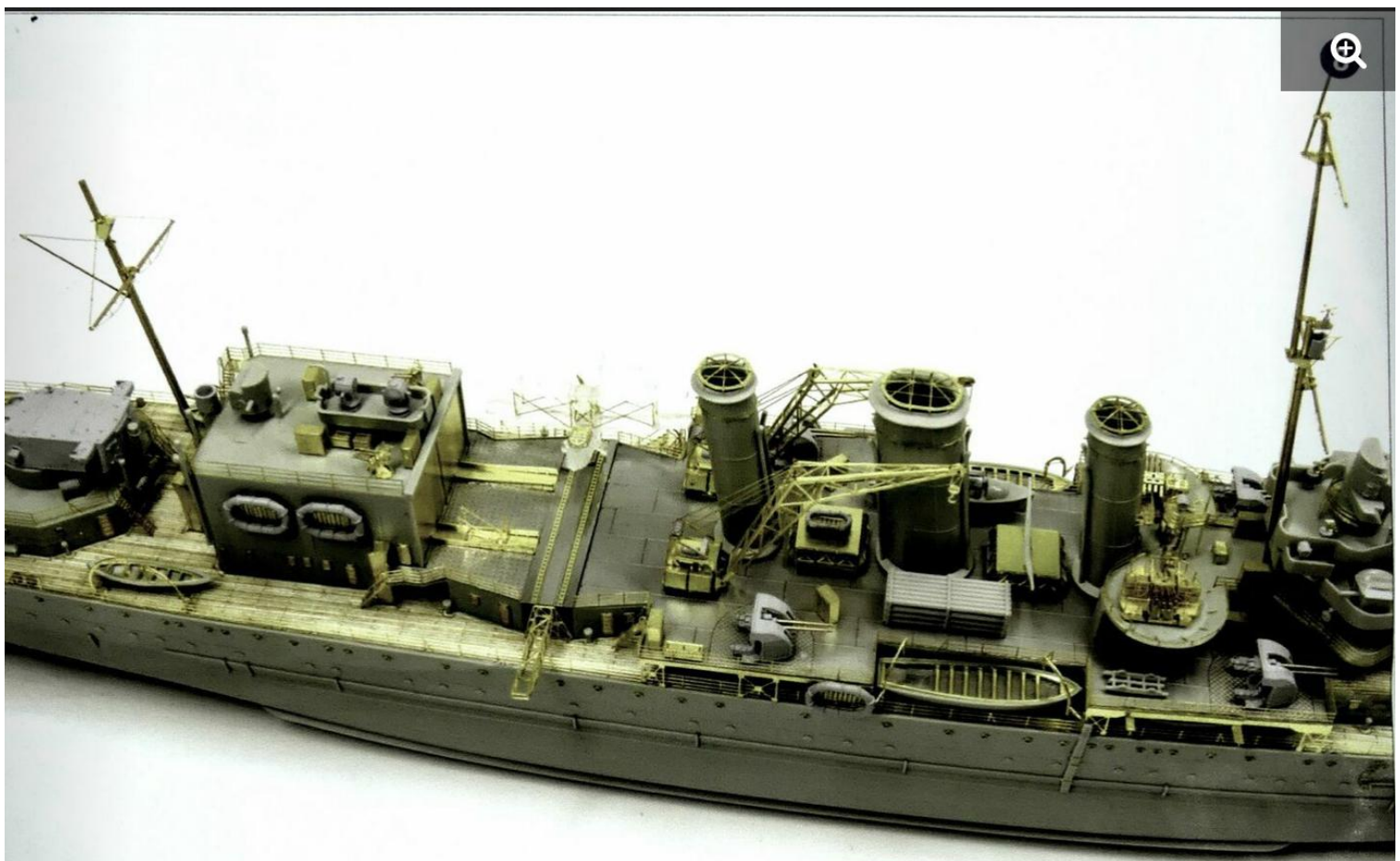

[www.mojehobby.pl](http://www.mojehobby.pl) [www.super-hobby.com](http://www.super-hobby.com)

