







-  CUT OFF
 -  BEND
 -  OPTION
 -  DRILL
 -  SYMETRICAL ASSEMBLY
- USE CYANOACRYLATE ADHESIVE I

Sherman Dozer Blade M1

RESIN CONVERSION FOR ANY SERMAN

72 014

CAT. No.

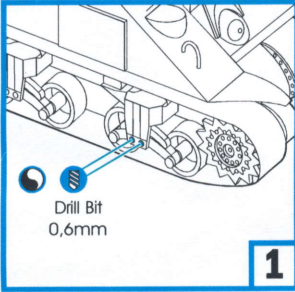

RESIN PARTS:

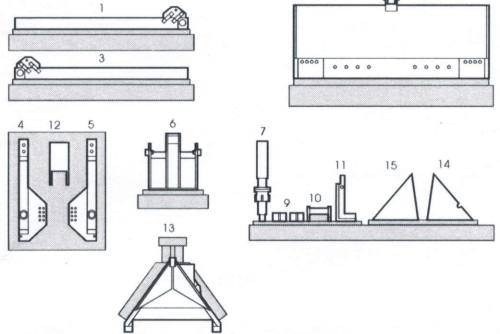

2

