

1

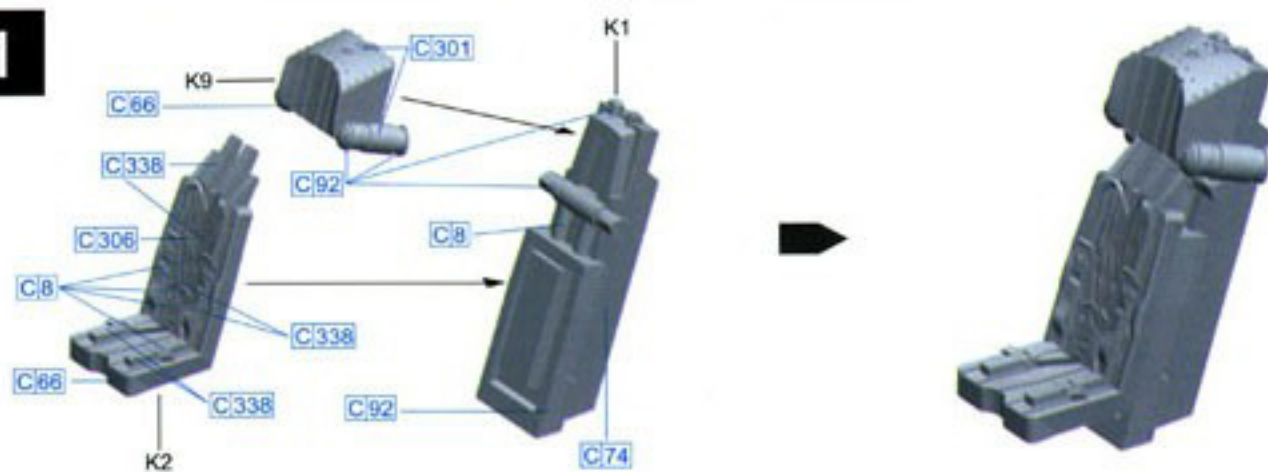

2

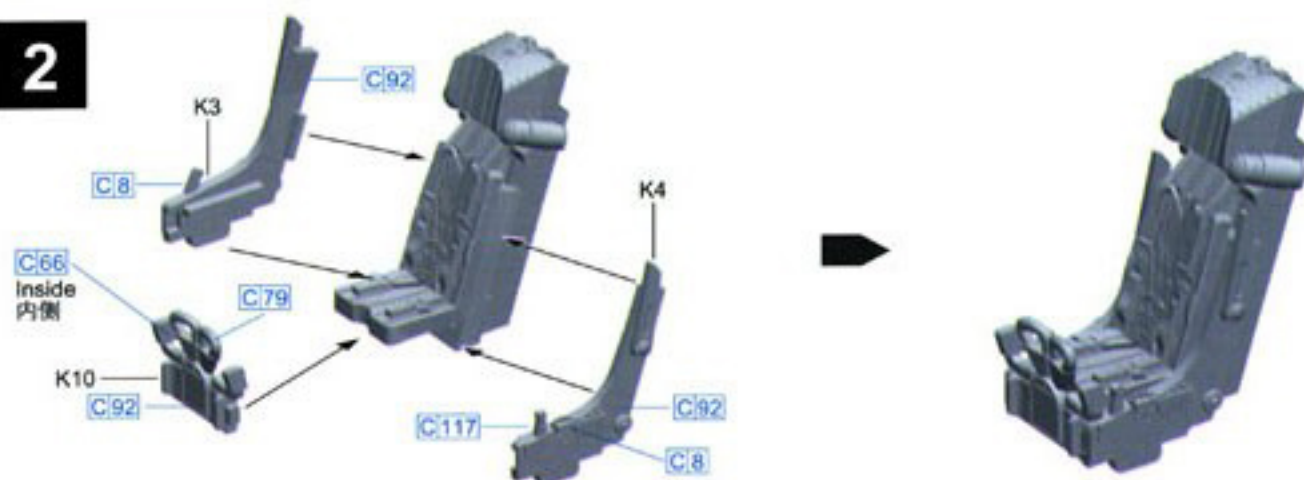

3

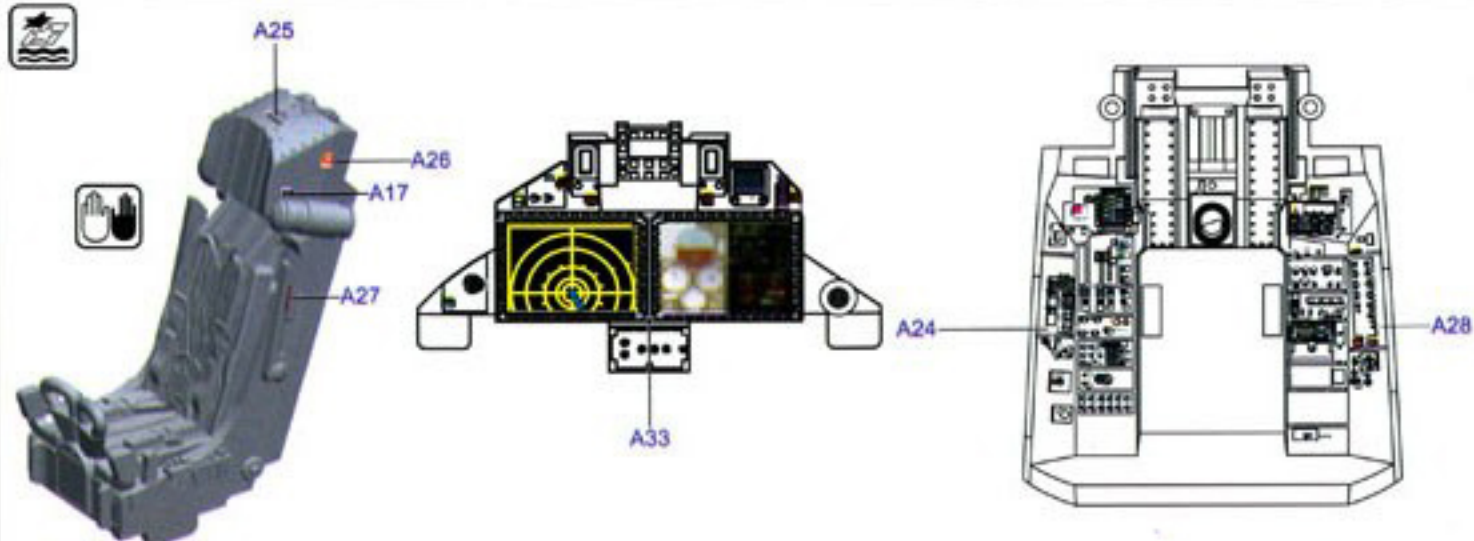
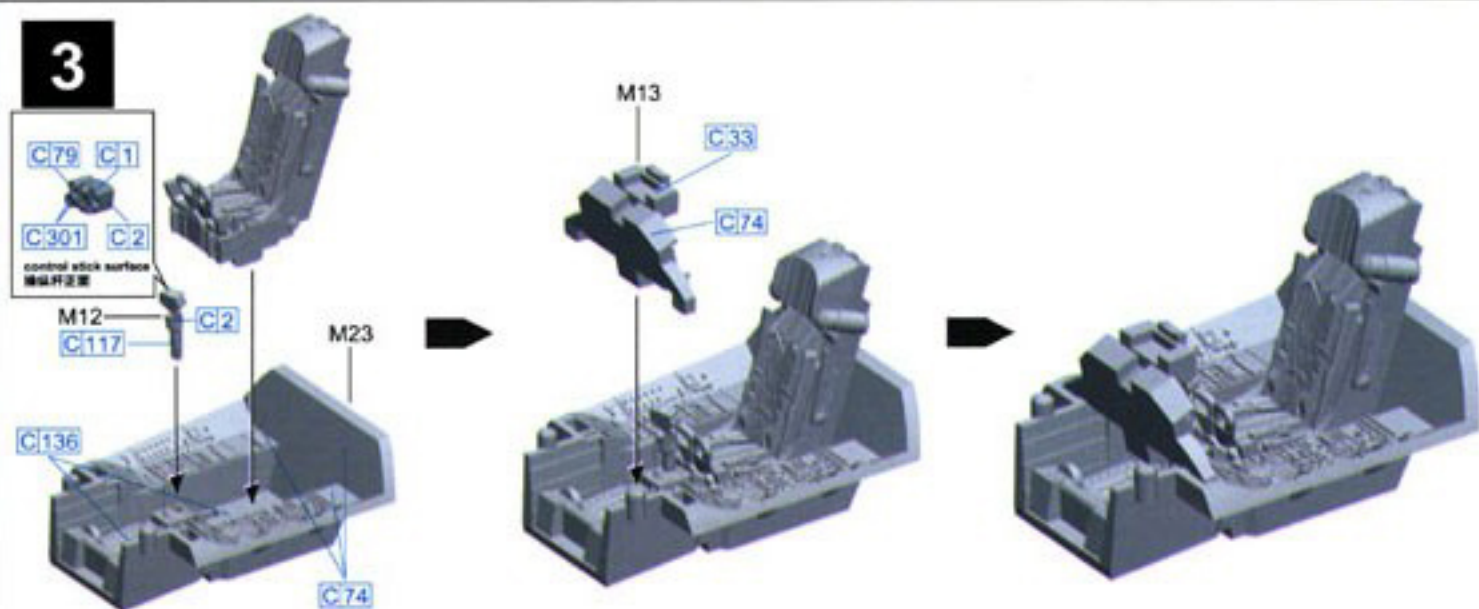

4

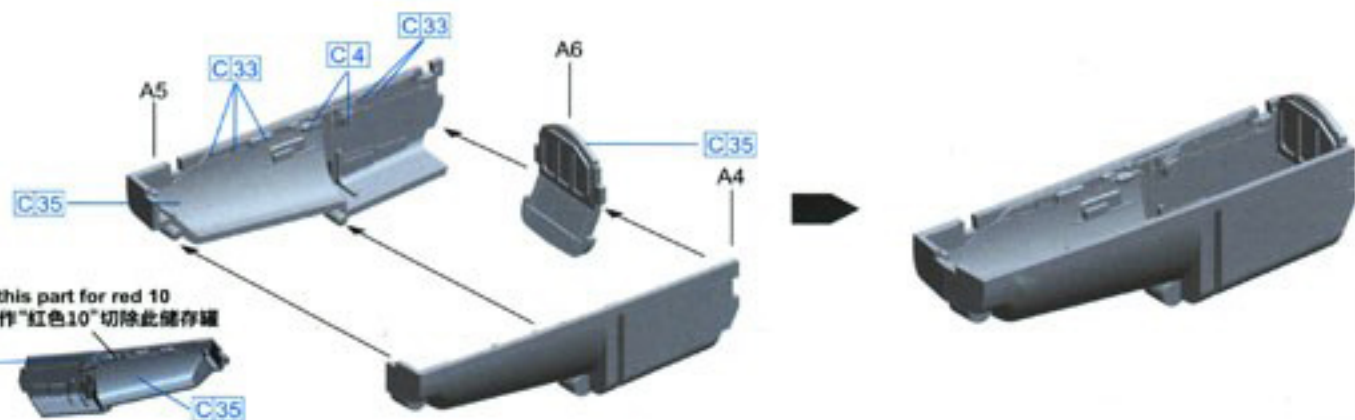

5

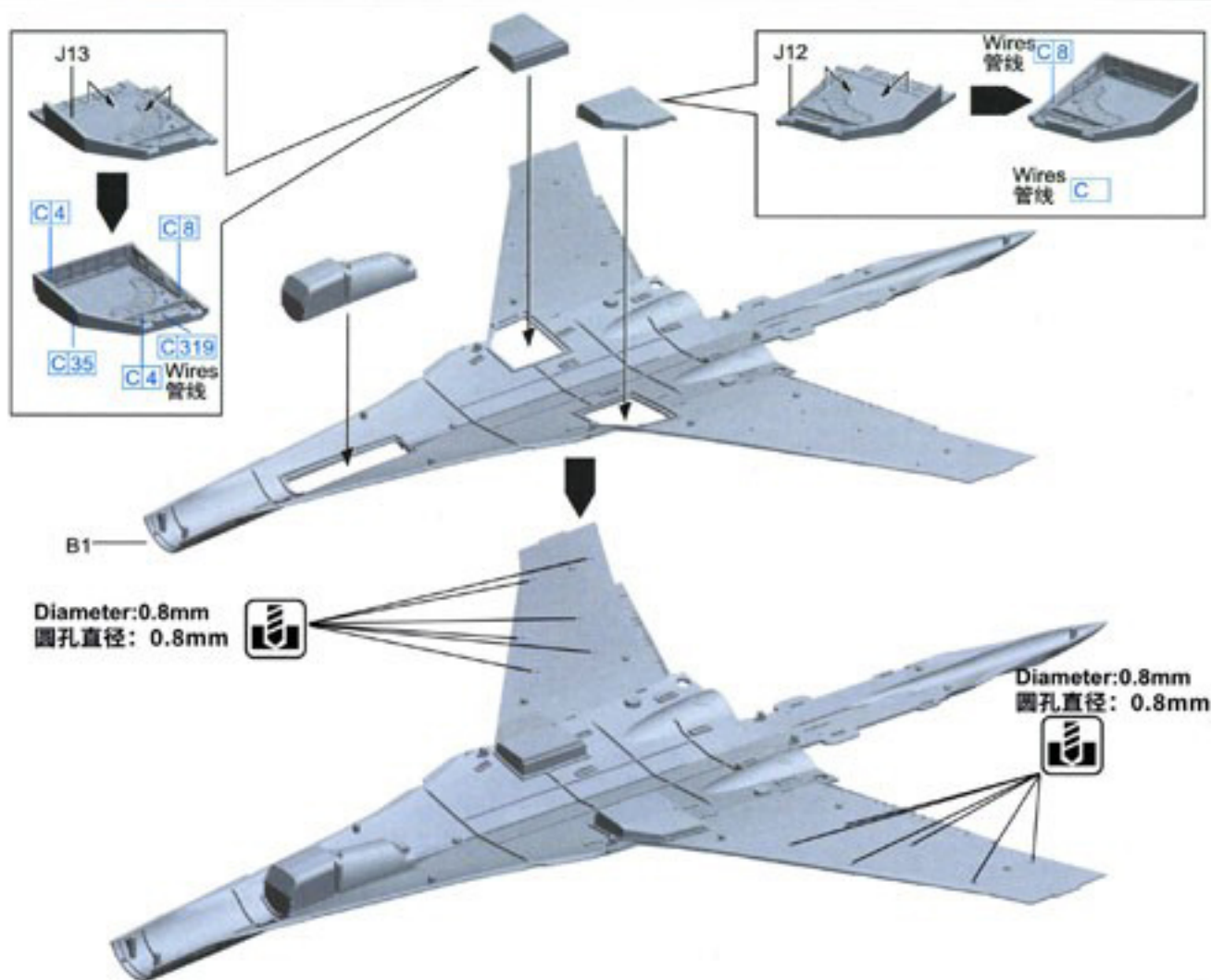

6

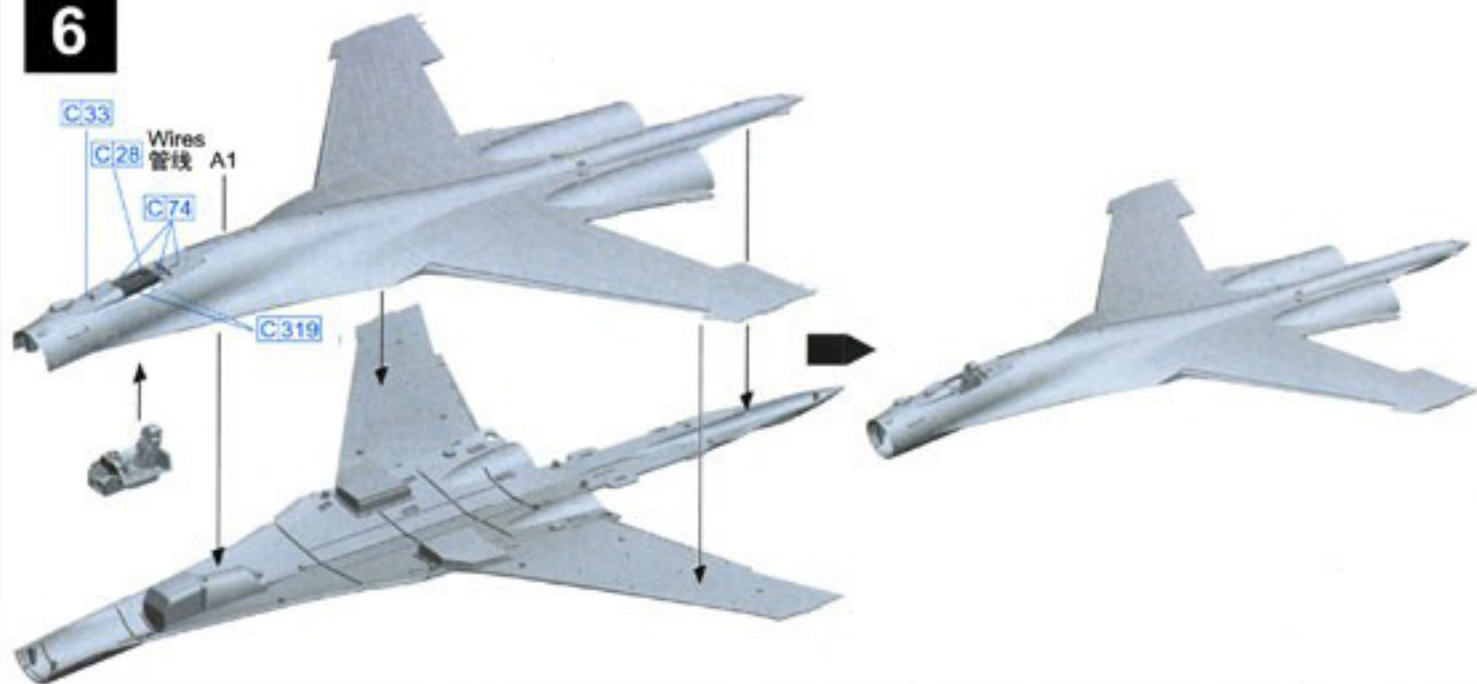

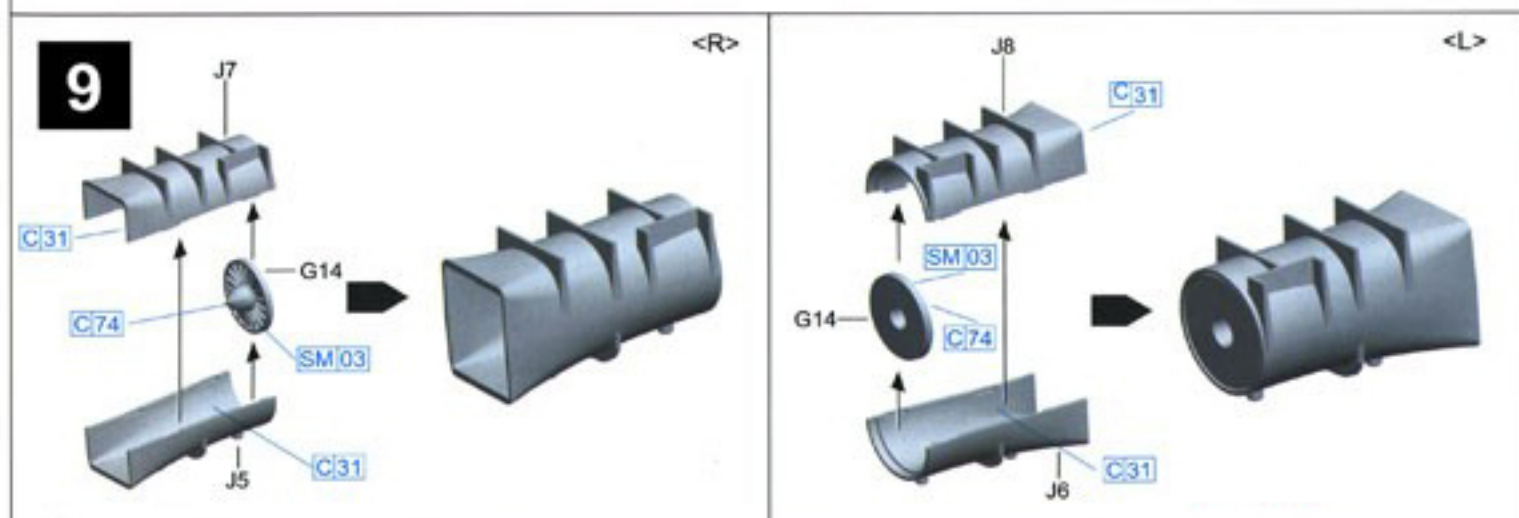
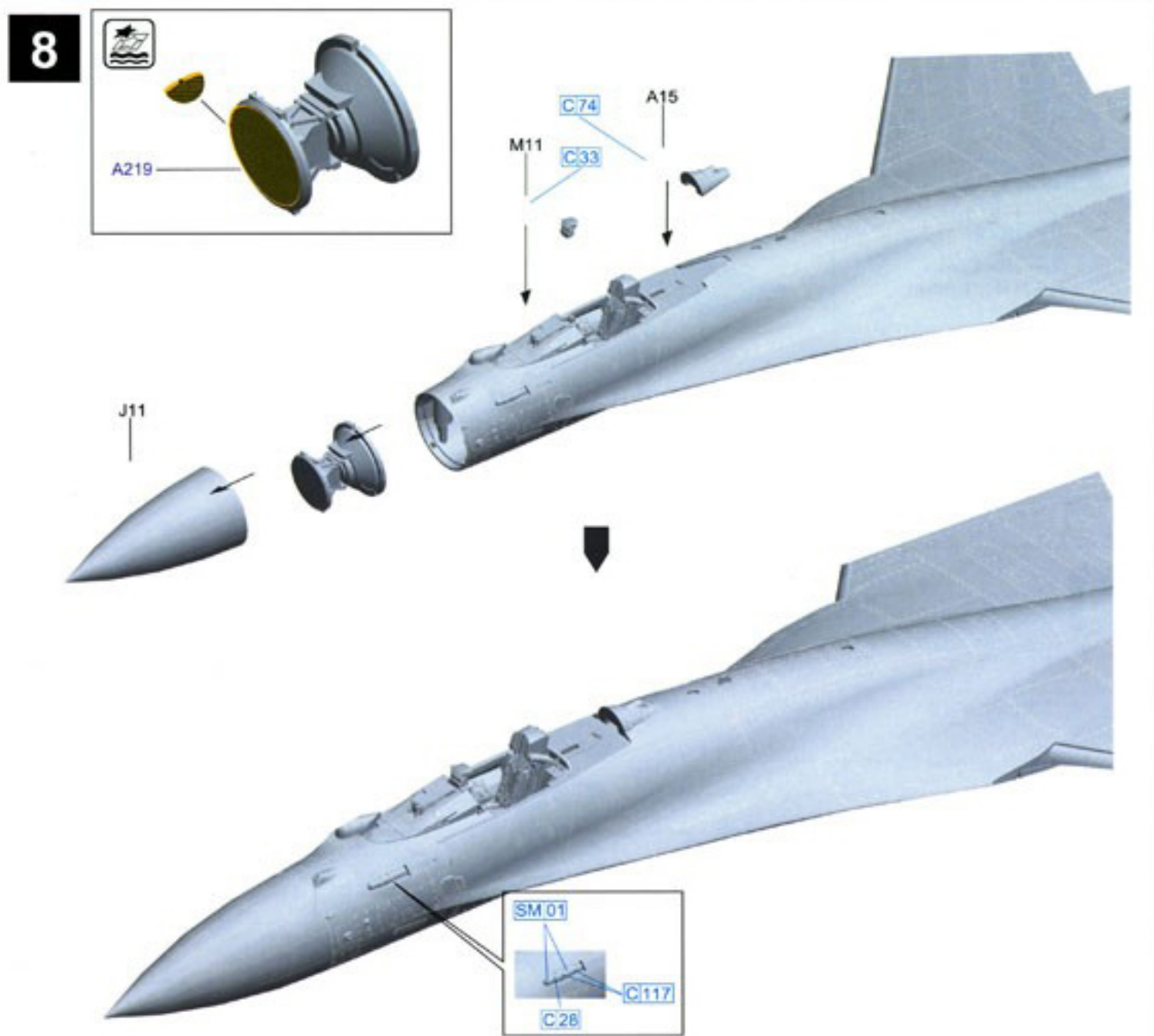

# 10

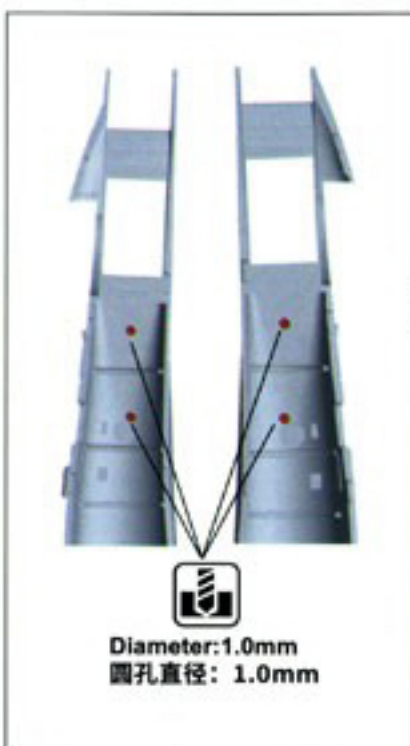

Serial number  
生产序列号

- A216
- A217
- A218

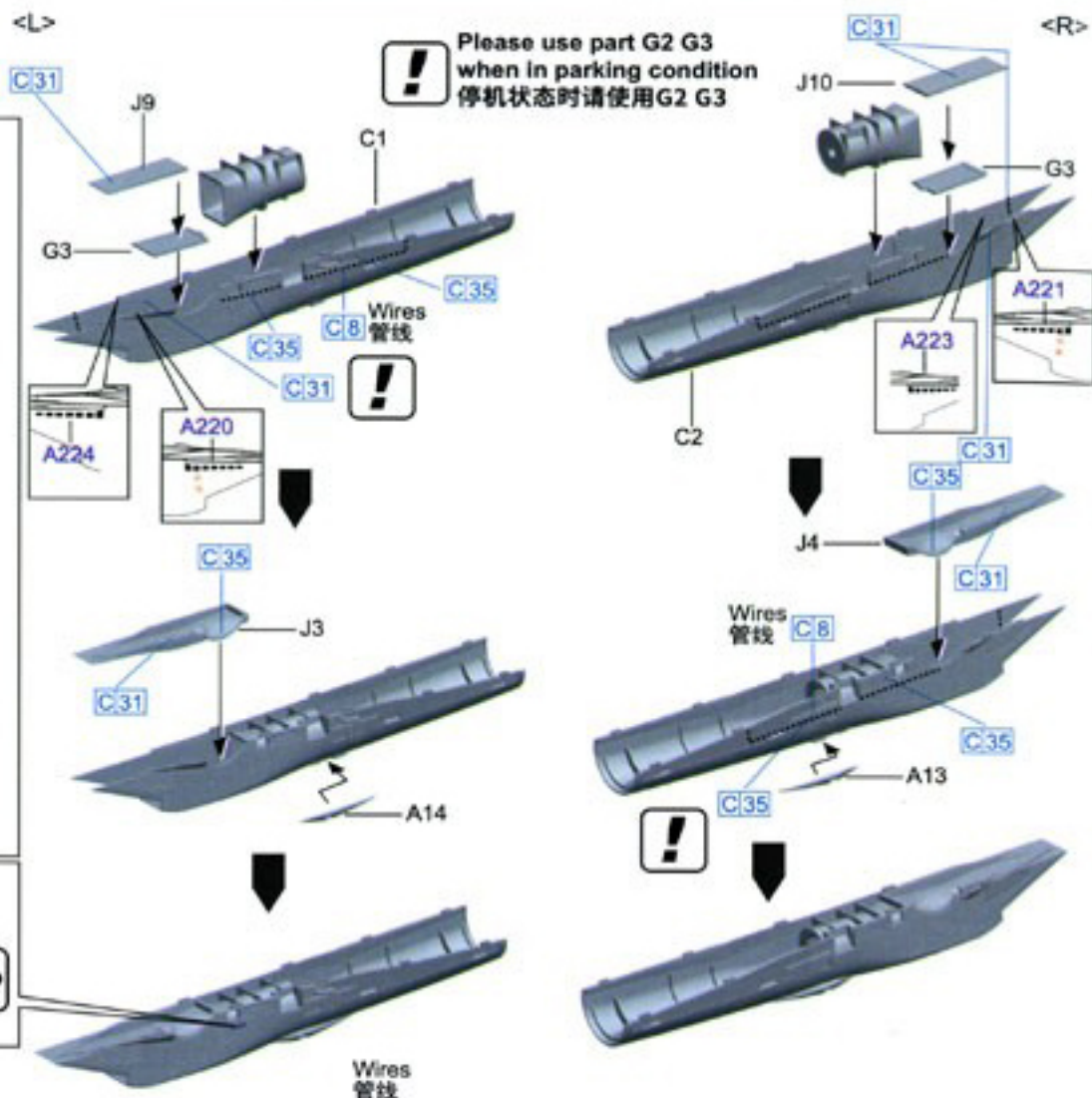

# 11

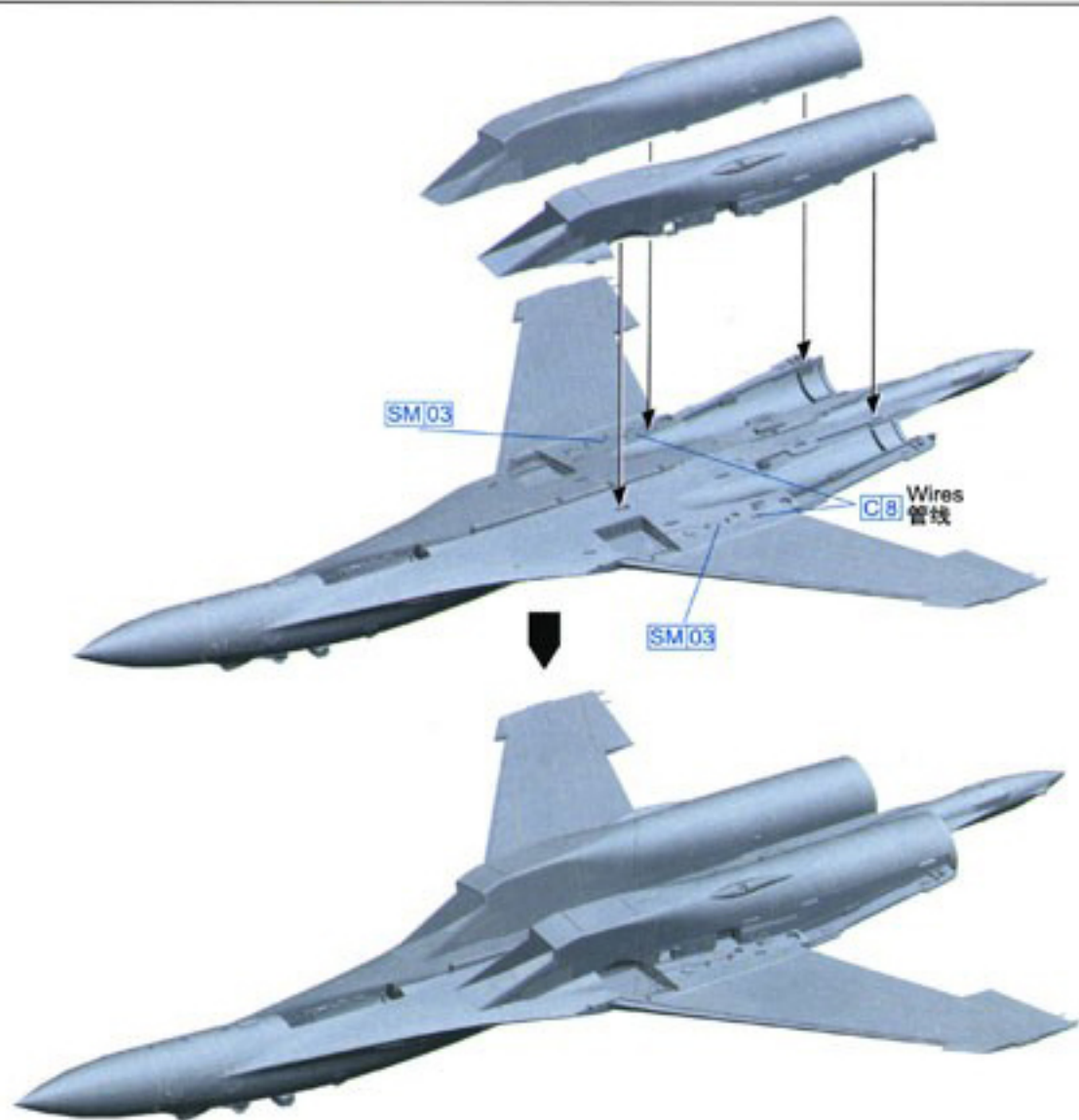

12

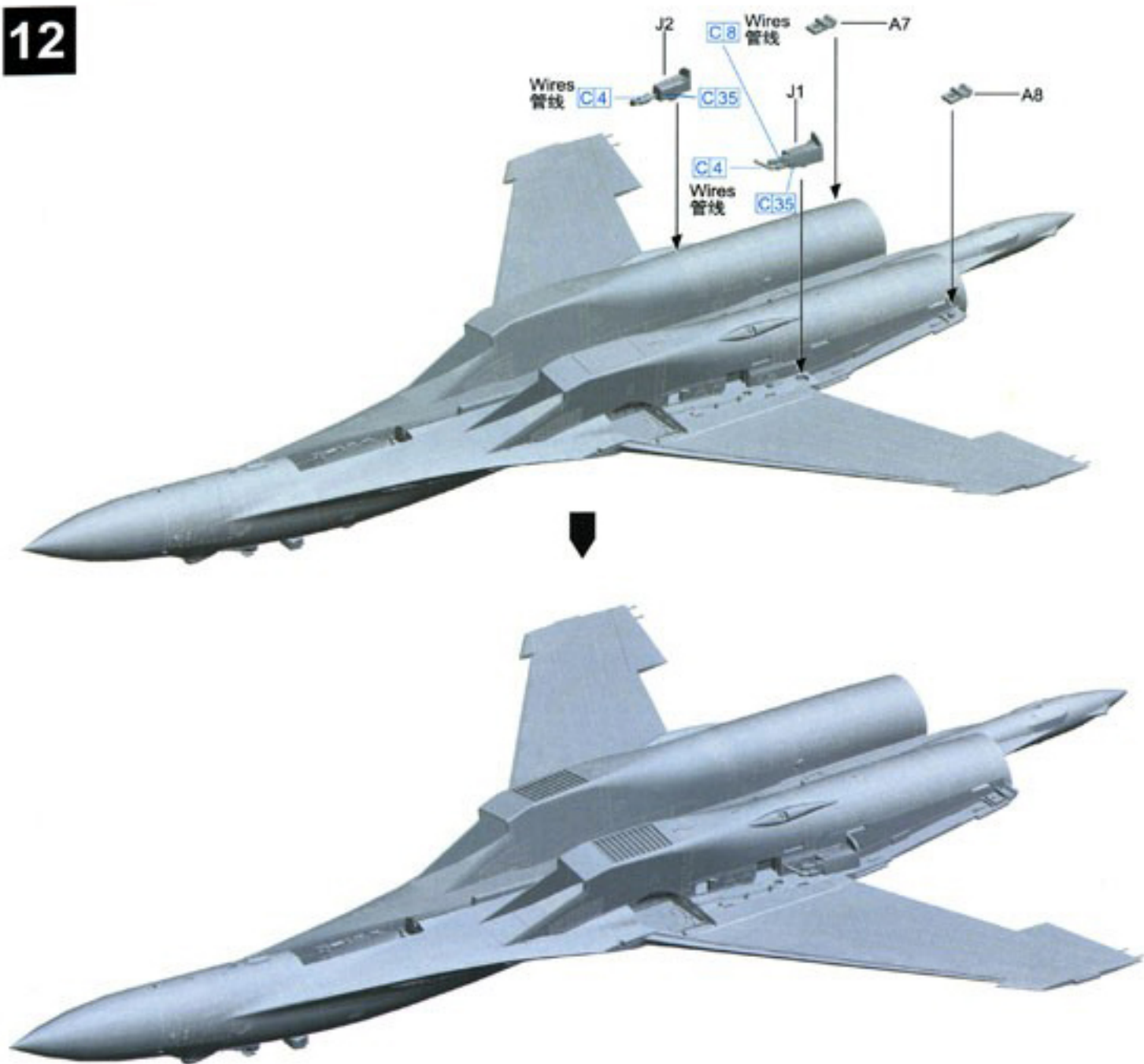

13

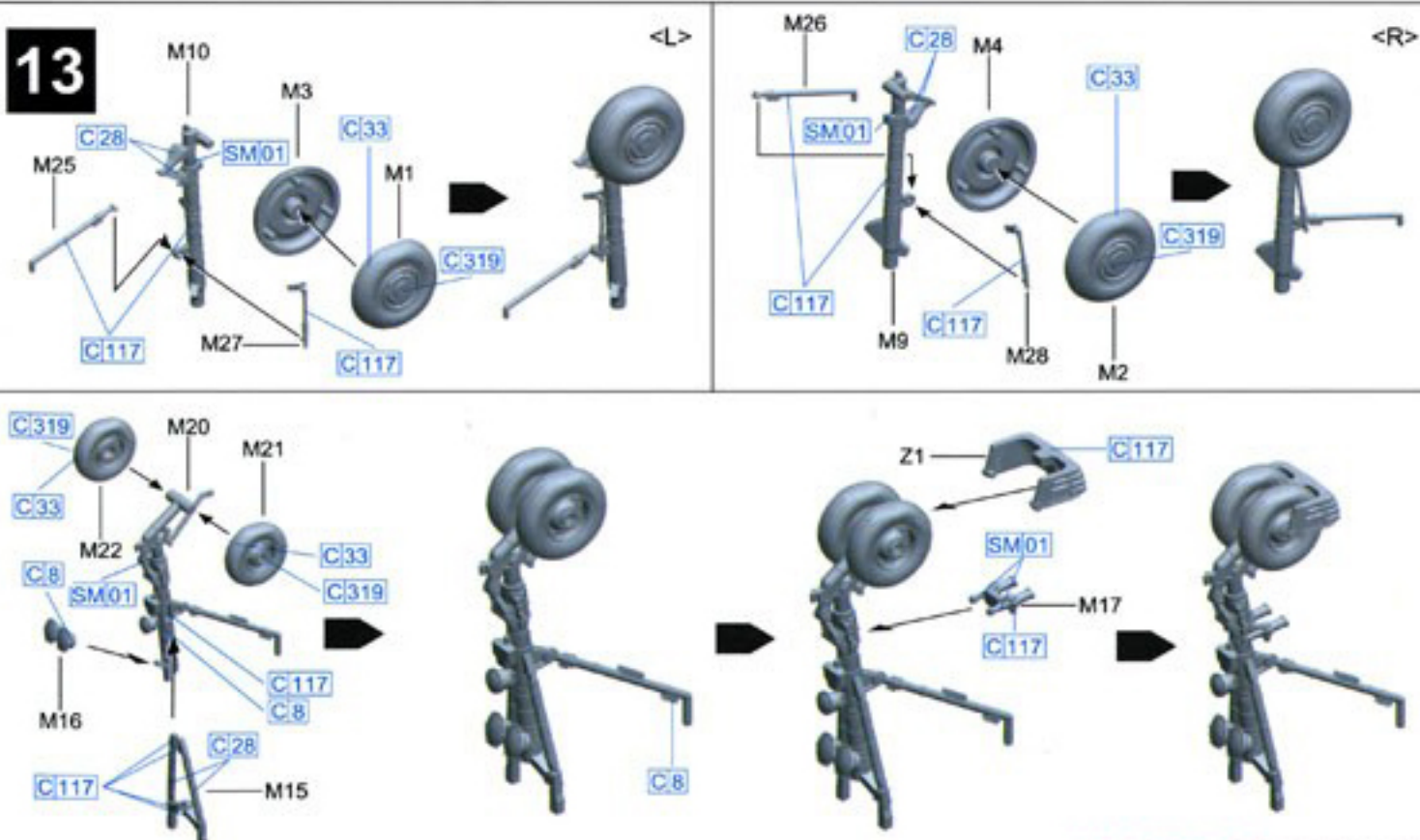

14

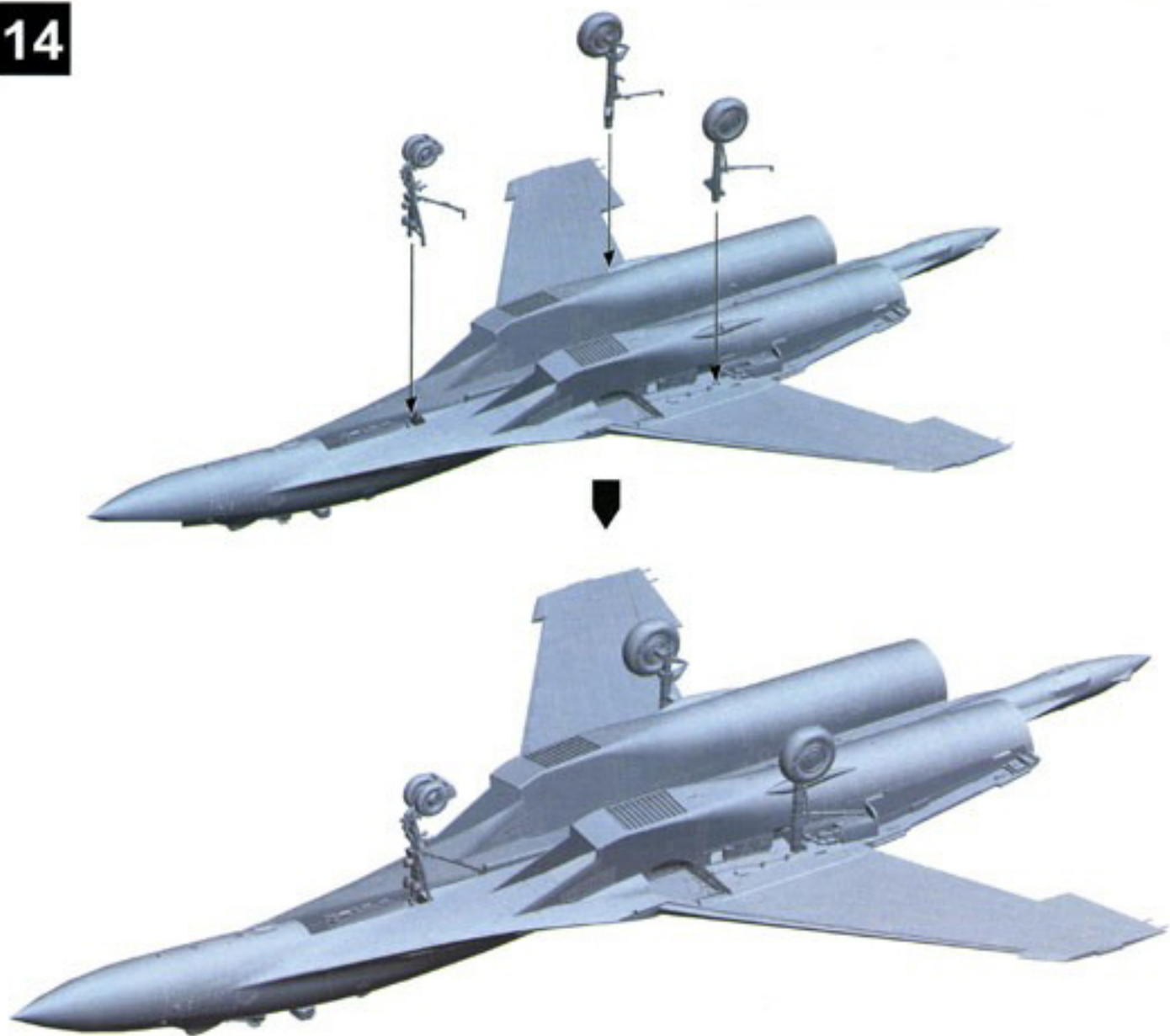

15

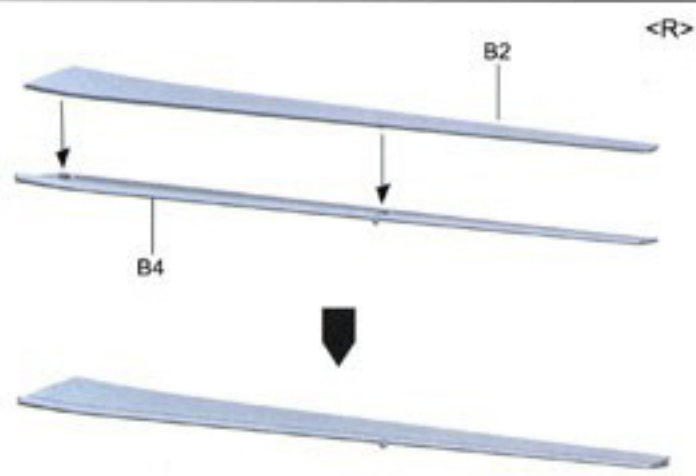
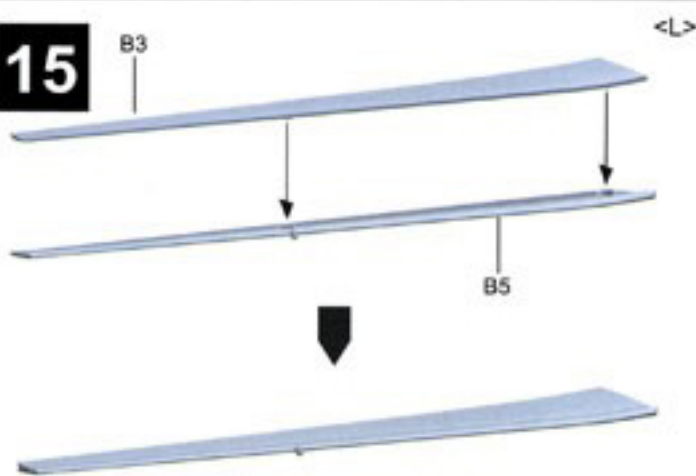

16

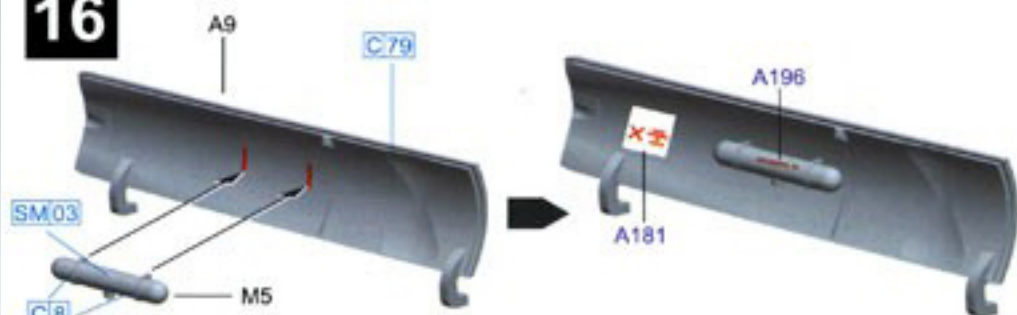

Part M5 and decal A196 is only for "Red 10"  
若制作“红色10”请安装M5号零件并使用水贴A196



Decal A187 is only for "red 24" "blue 24"  
若制作“红色24”或“蓝色24”请使用水贴A187

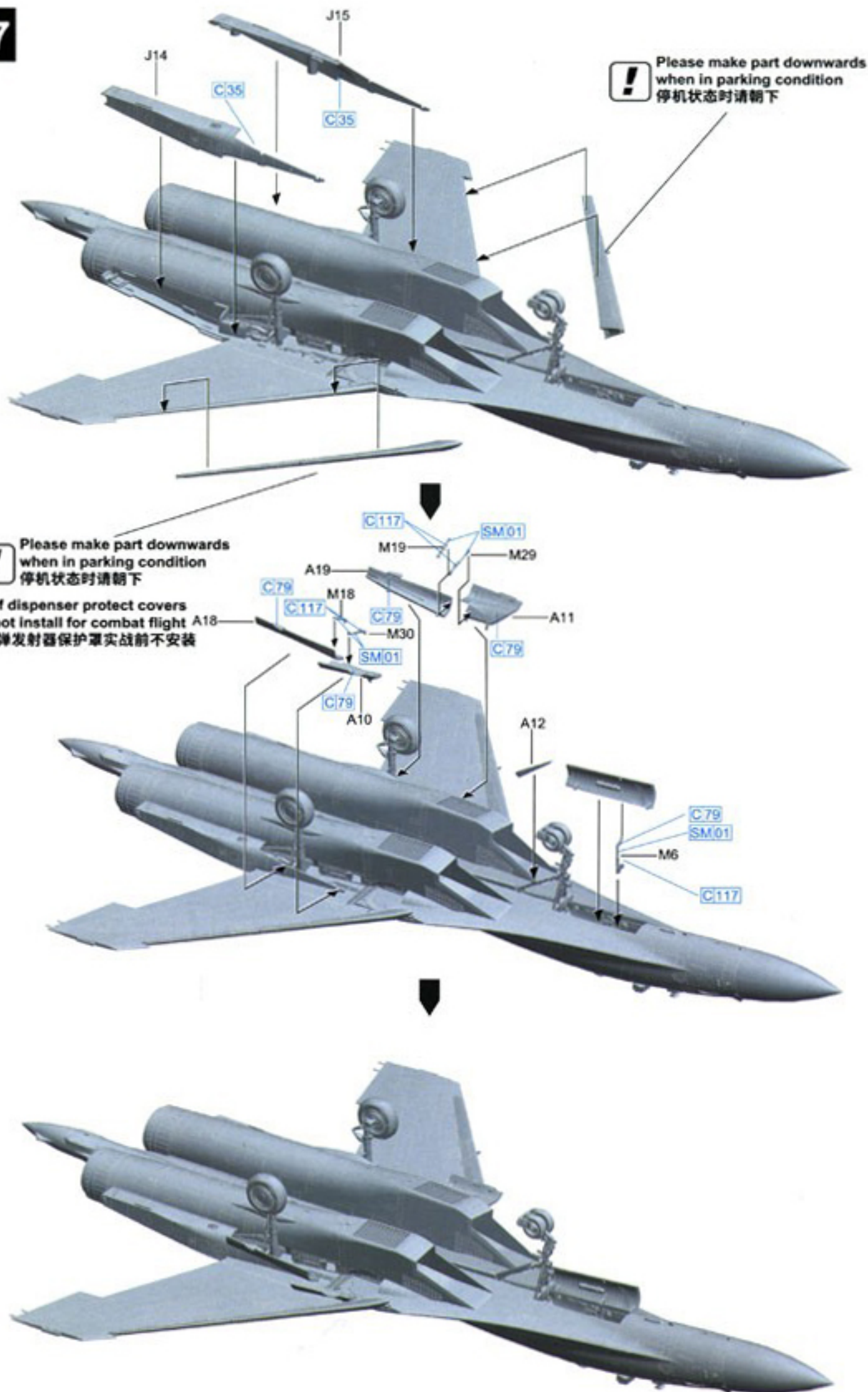

18

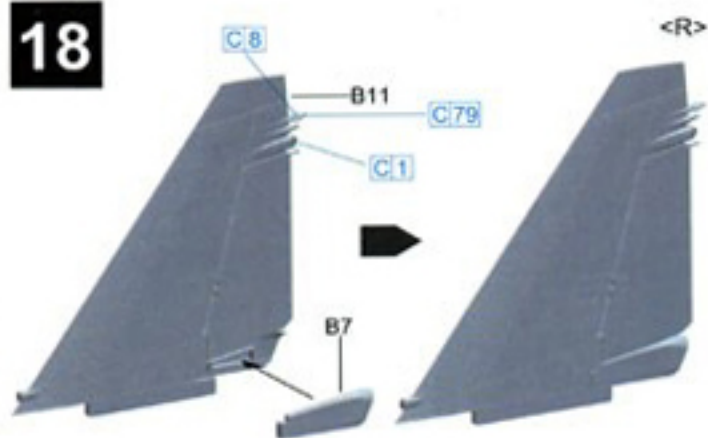

&lt;R&gt;

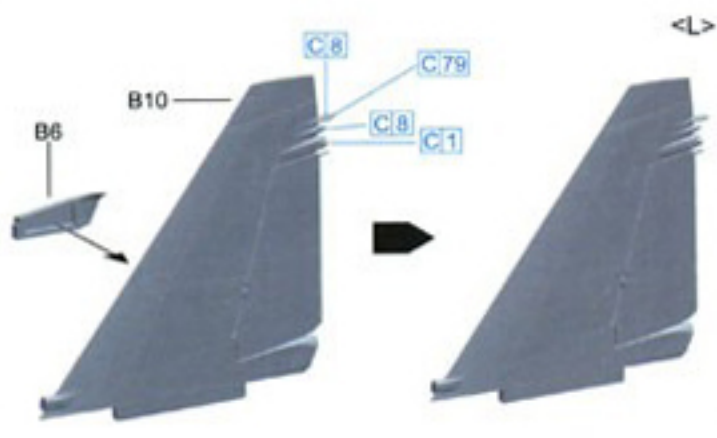

&lt;L&gt;

19

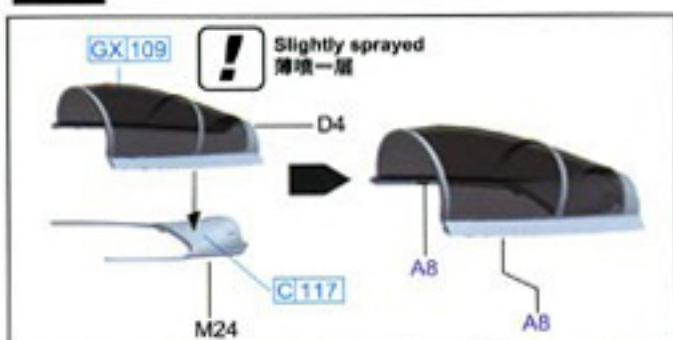
Slightly sprayed  
薄喷一层

Chaff dispenser  
protect covers  
do not install  
for combat flight  
干扰弹发射器保护  
罩实战前不安装

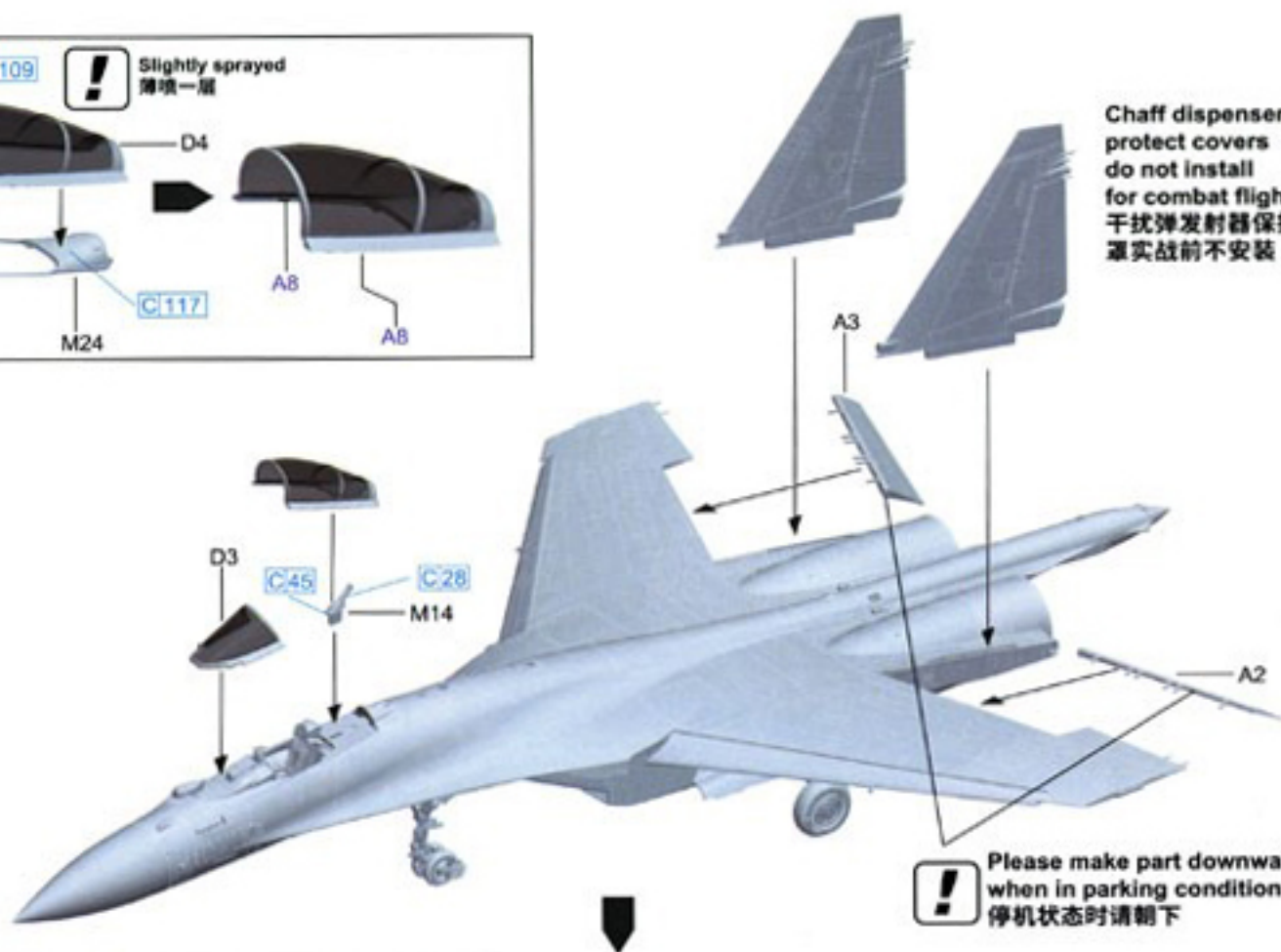

Please make part downwards  
when in parking condition  
停机状态时请朝下

Close State  
关闭状态



Open State  
打开状态





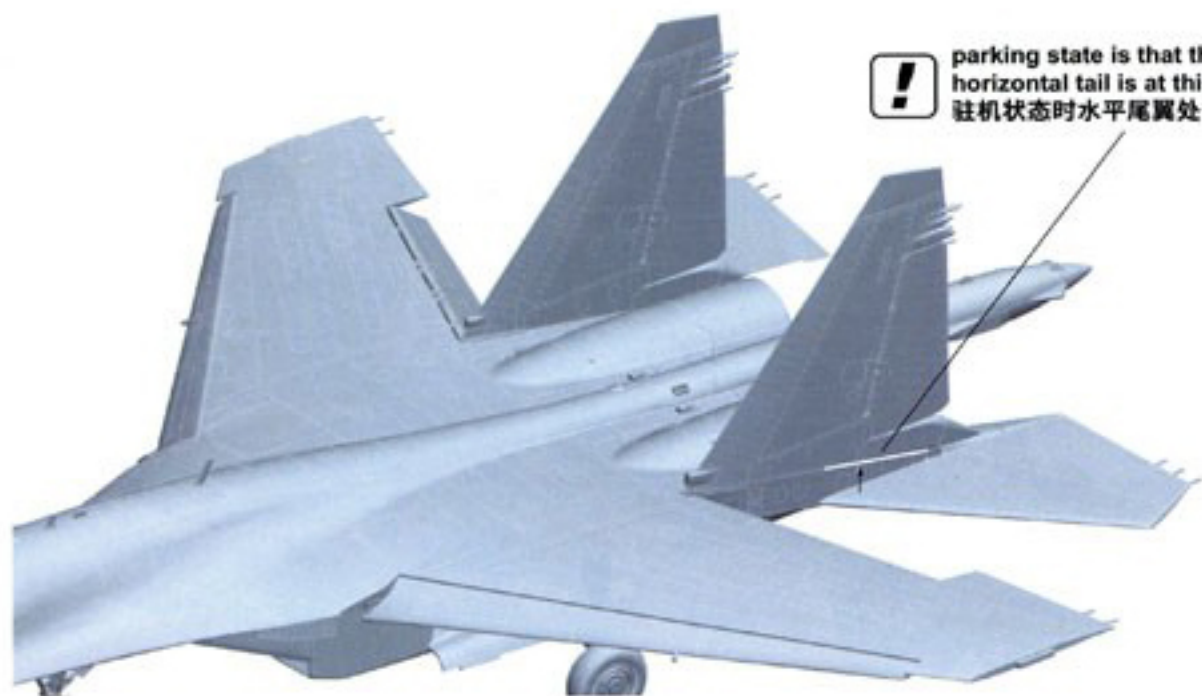
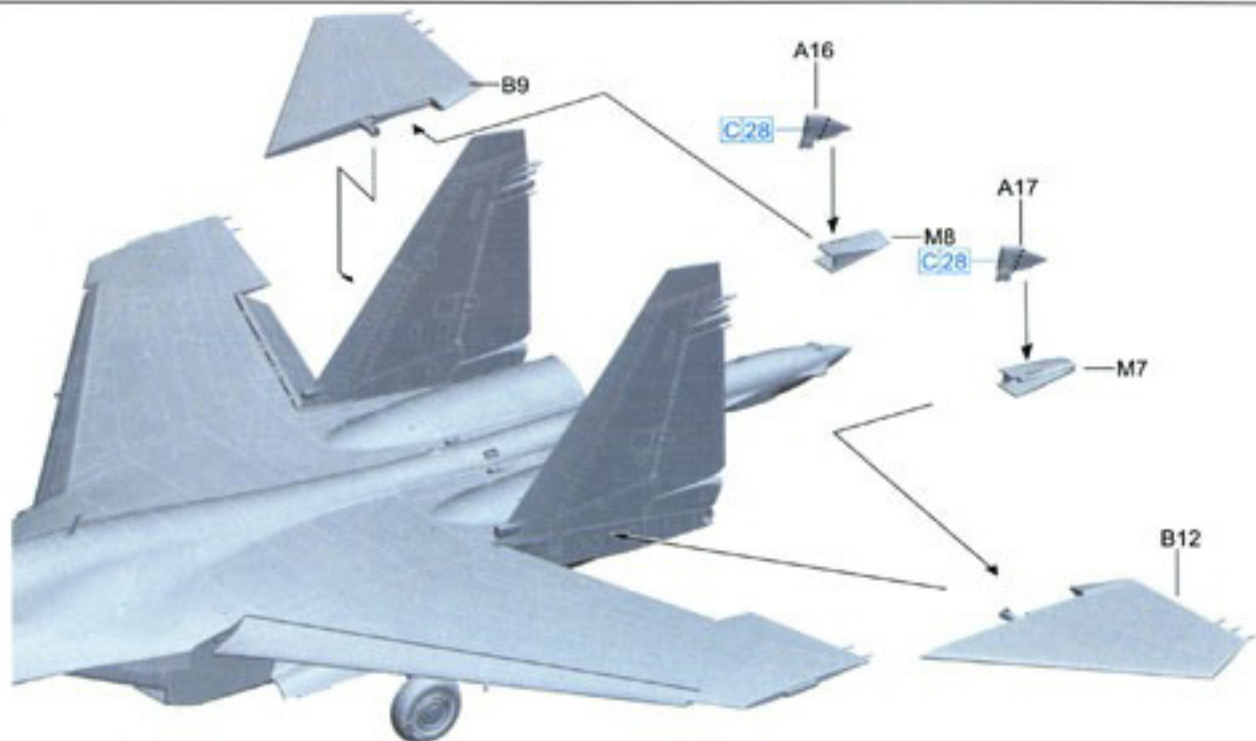

21 Open State  
打开状态

For parking condition  
驻机姿态使用

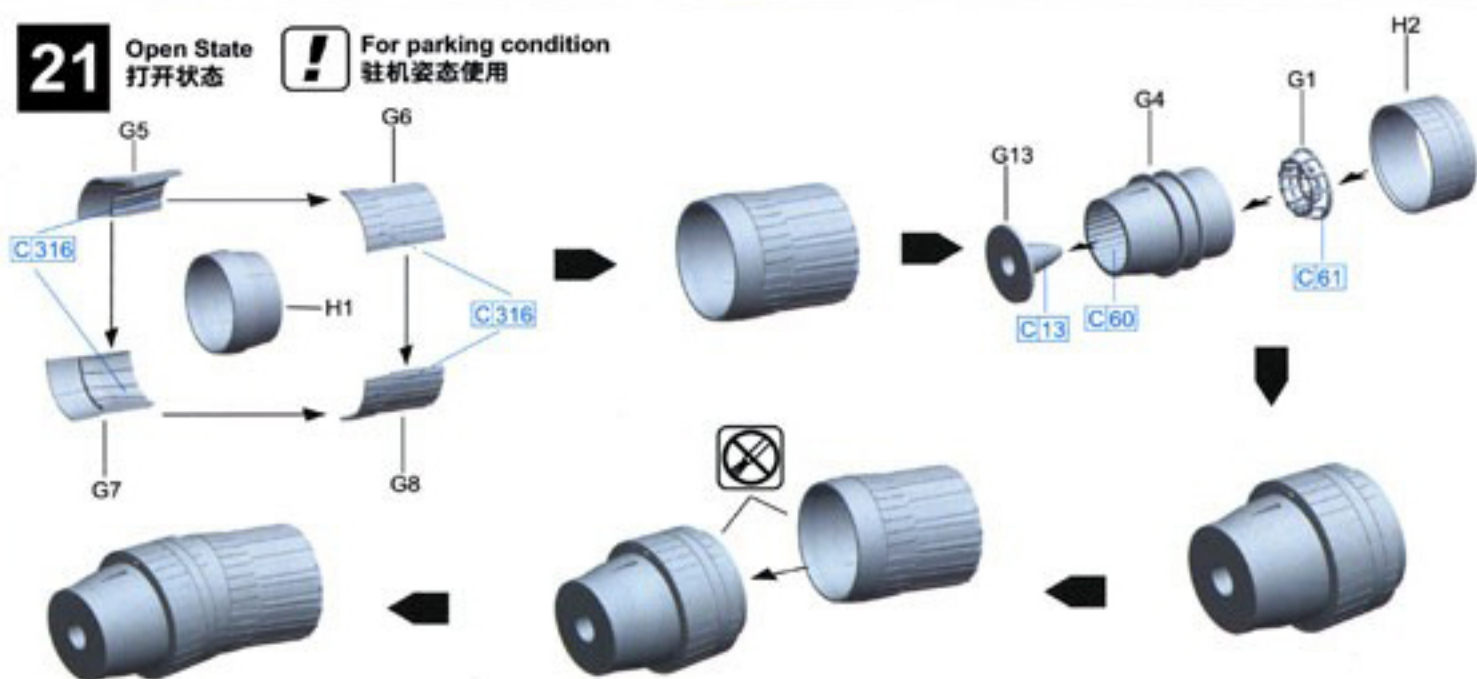

22

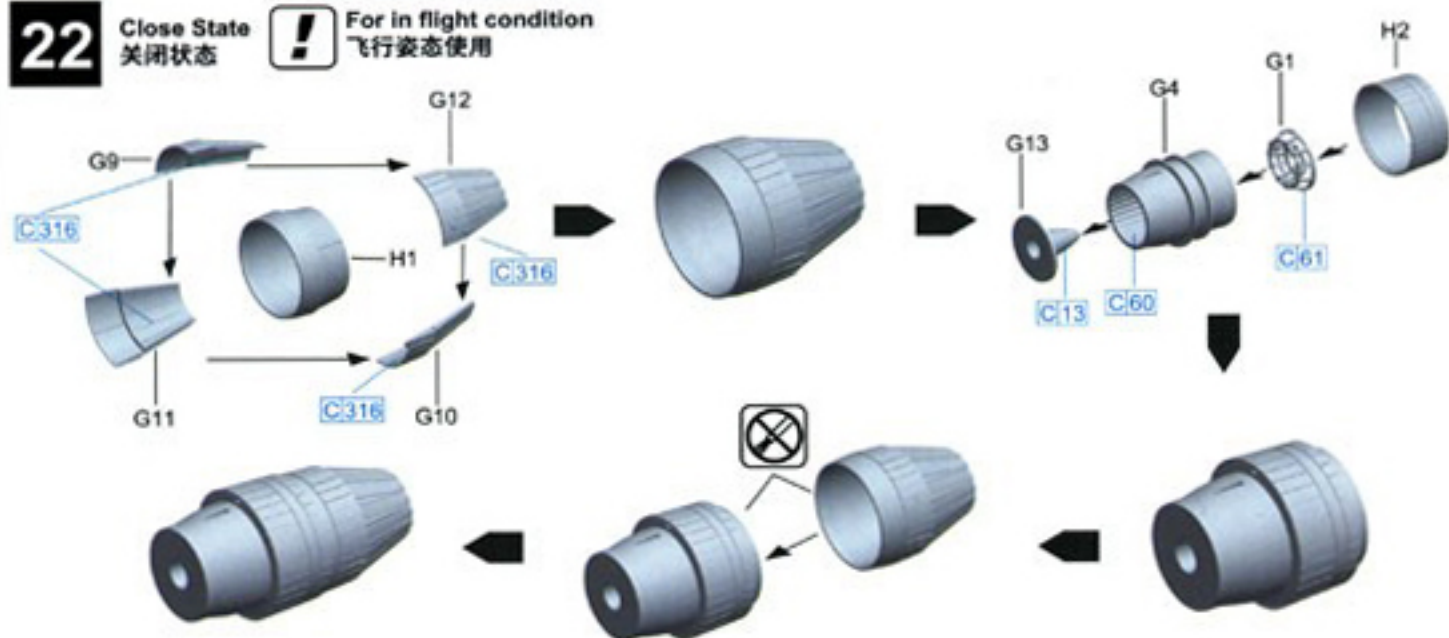
Close State  
关闭状态For in flight condition  
飞行姿态使用

23

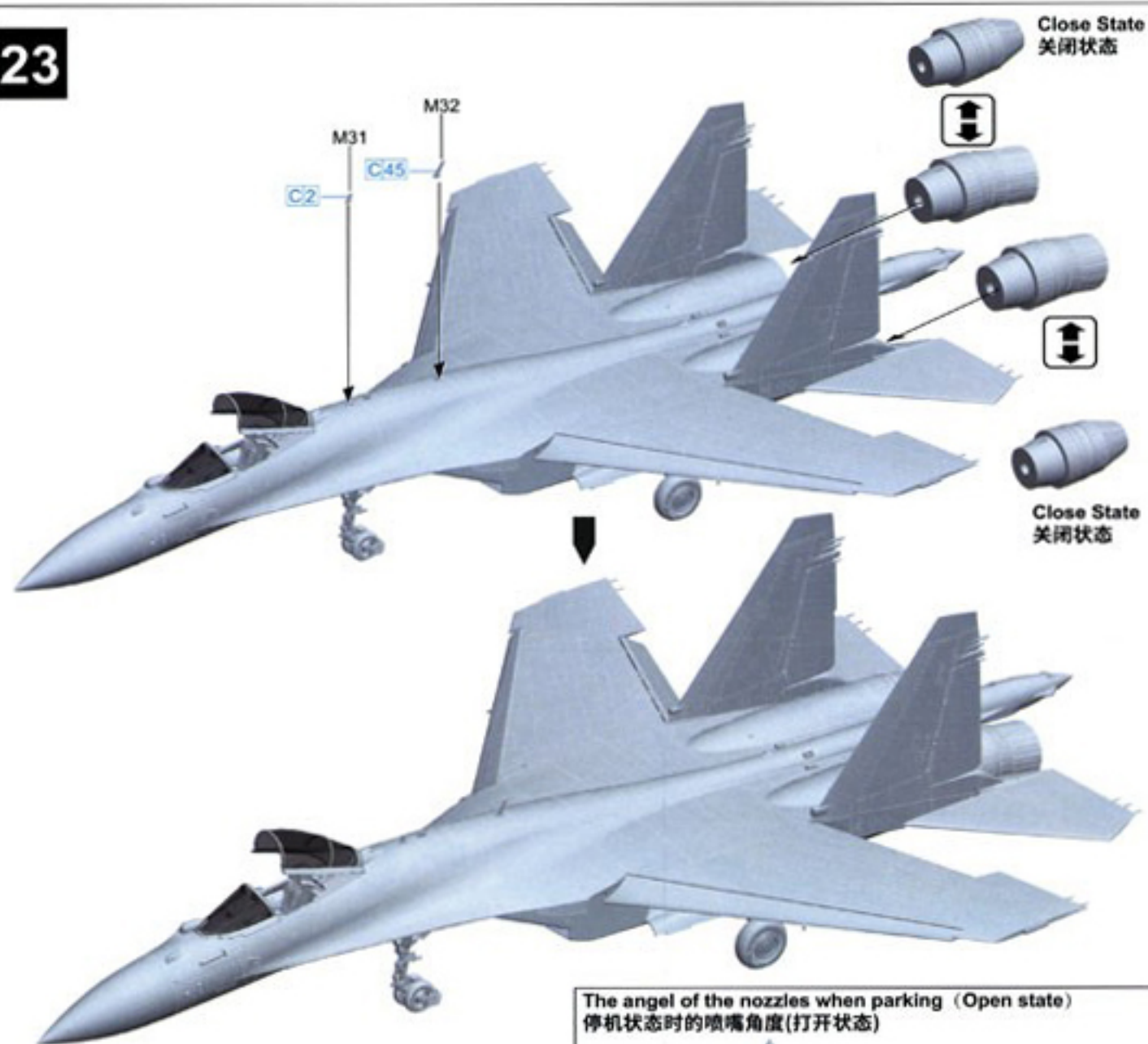
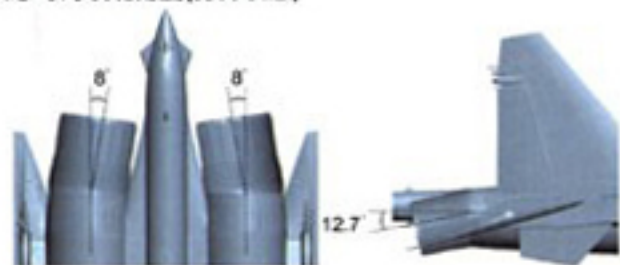
The angel of the nozzles when parking (Open state)  
停机状态时的喷嘴角度(打开状态)

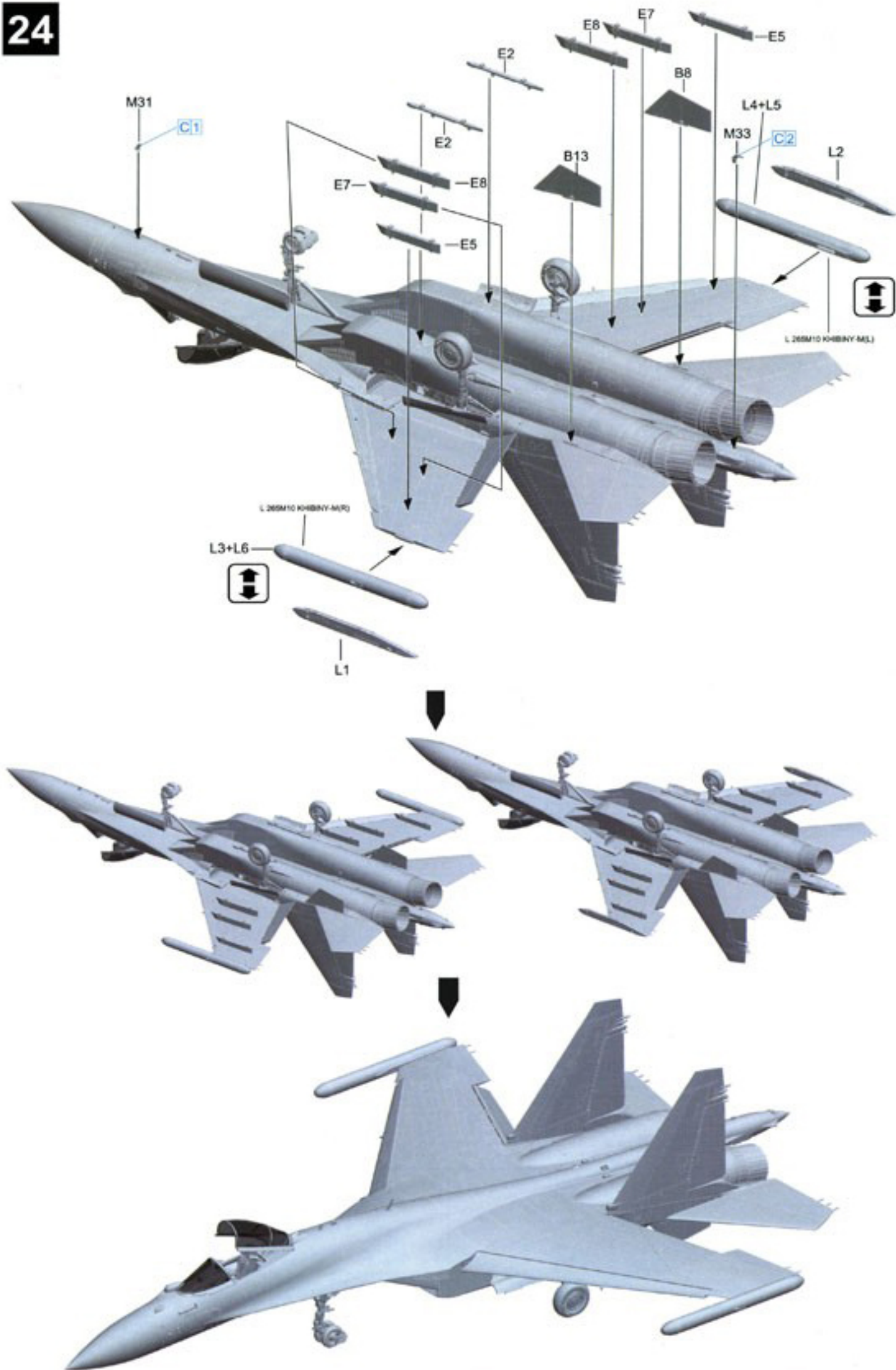



## R-27ER

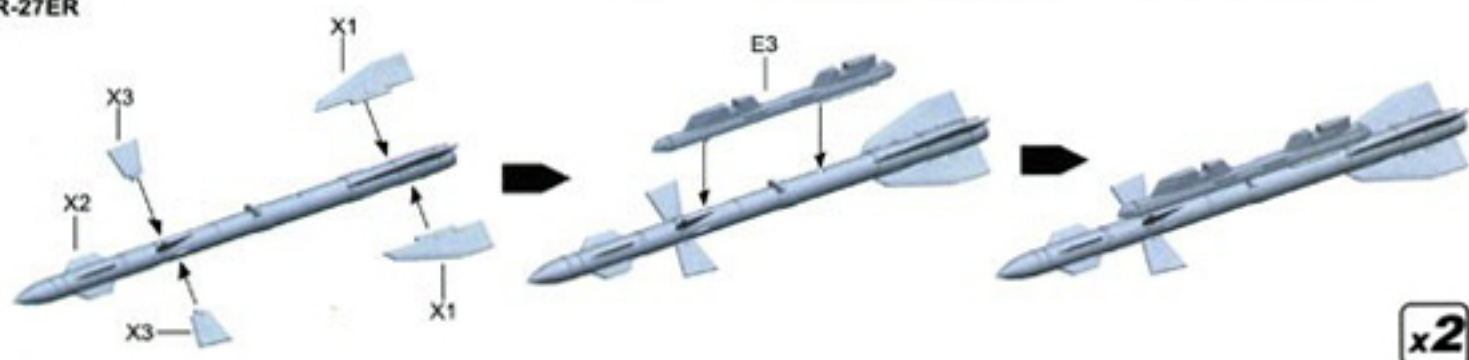

## R-27ET

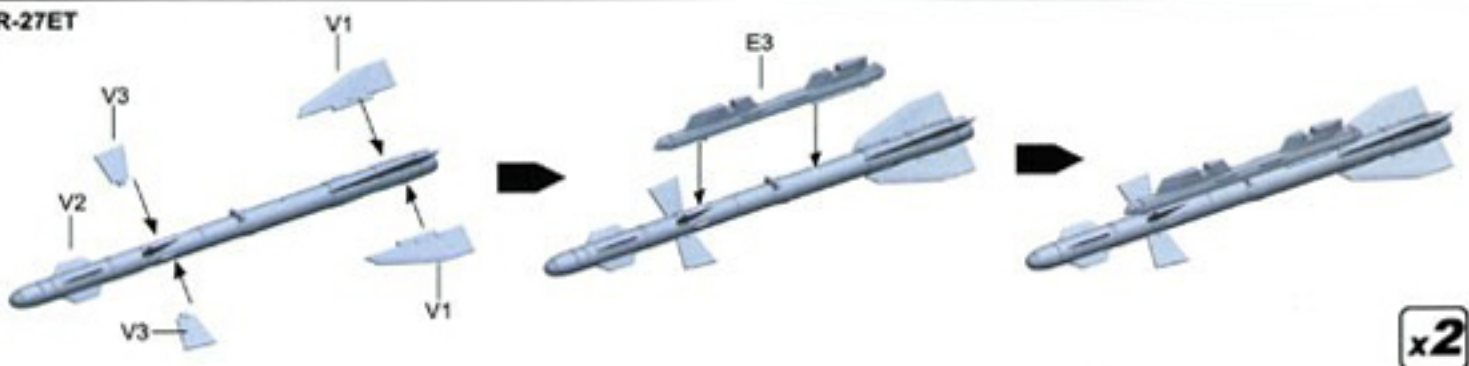

## R-77

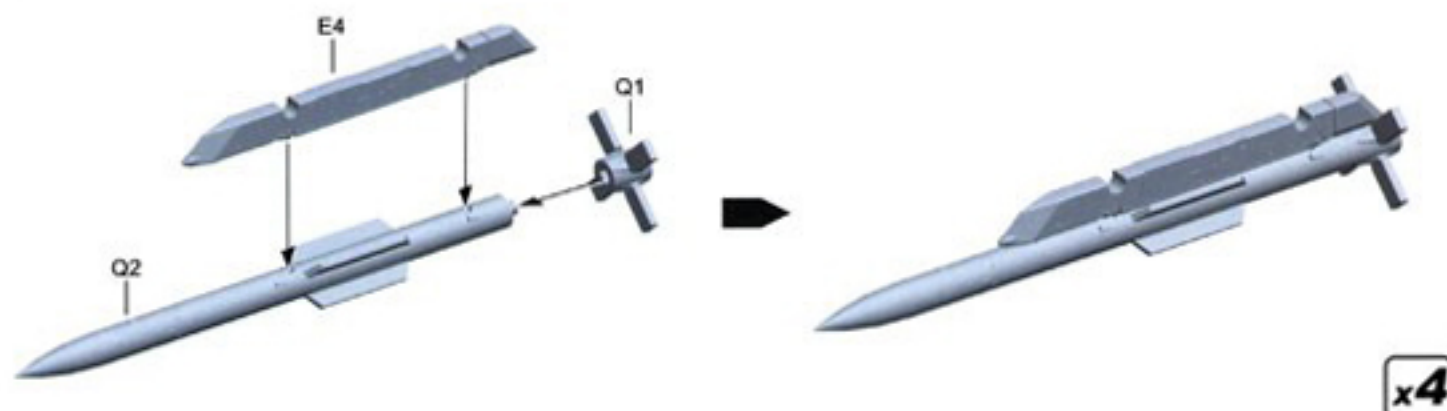

## R-73

Use nipper to cut trace for all 4 fins  
使用剪钳切一刀(4片弹翼)

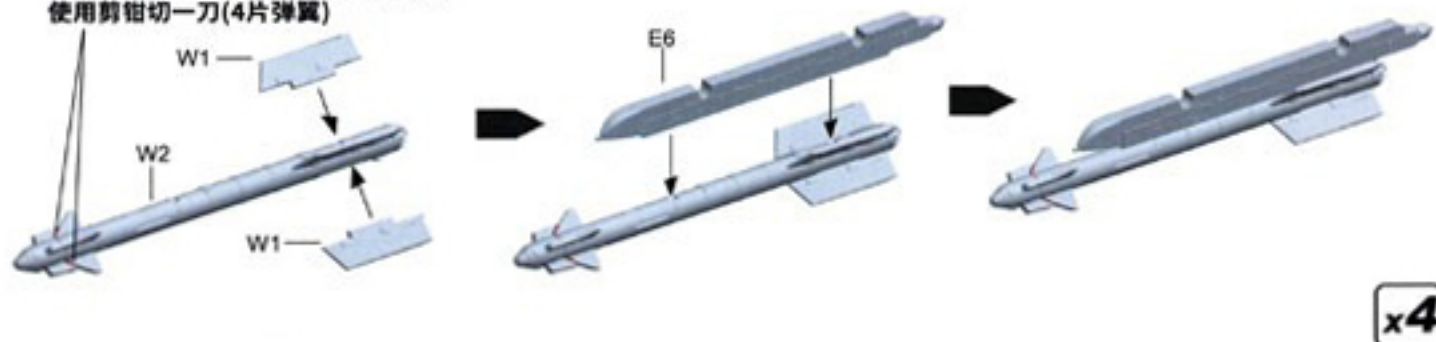

## (L)



## (R)



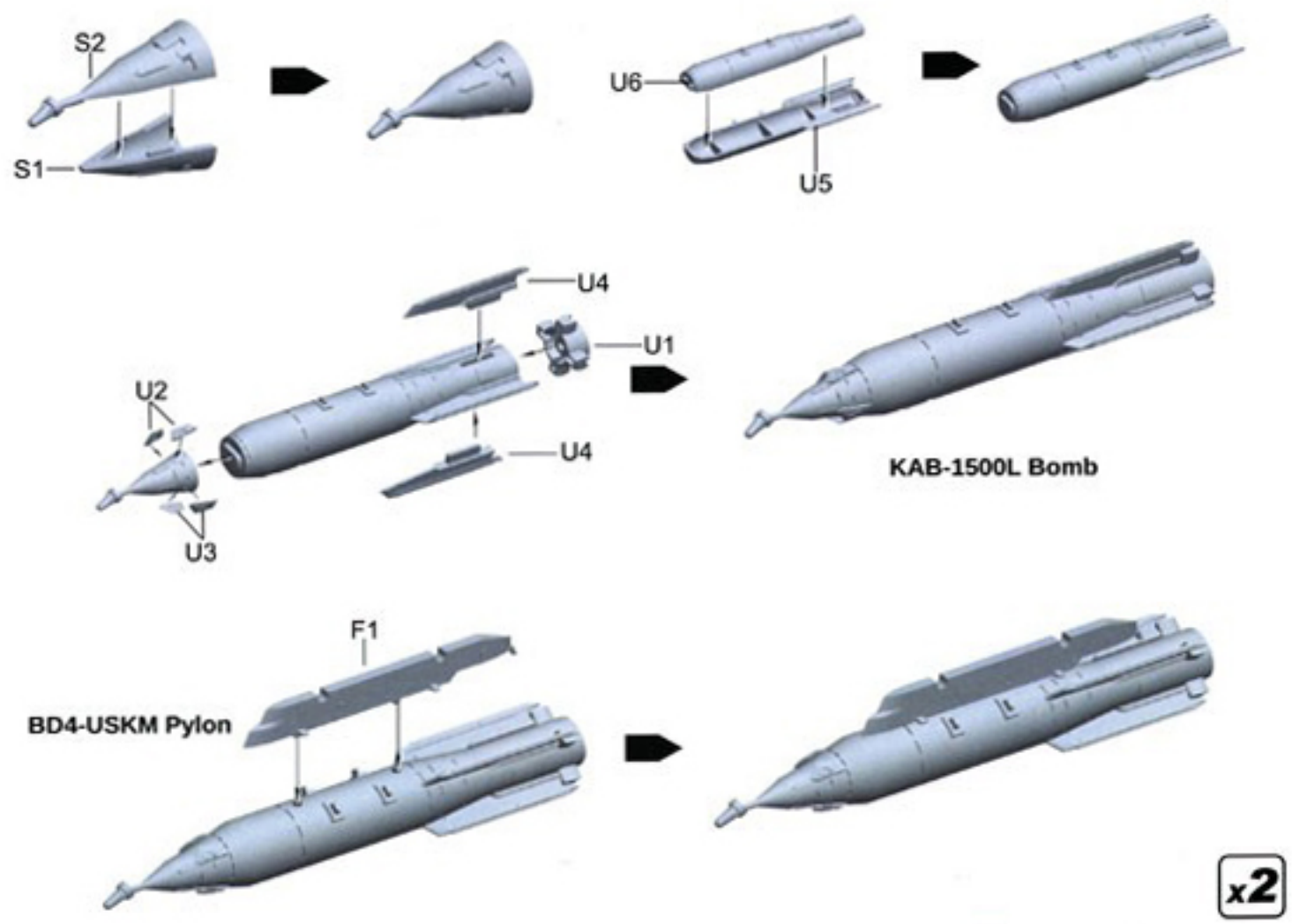
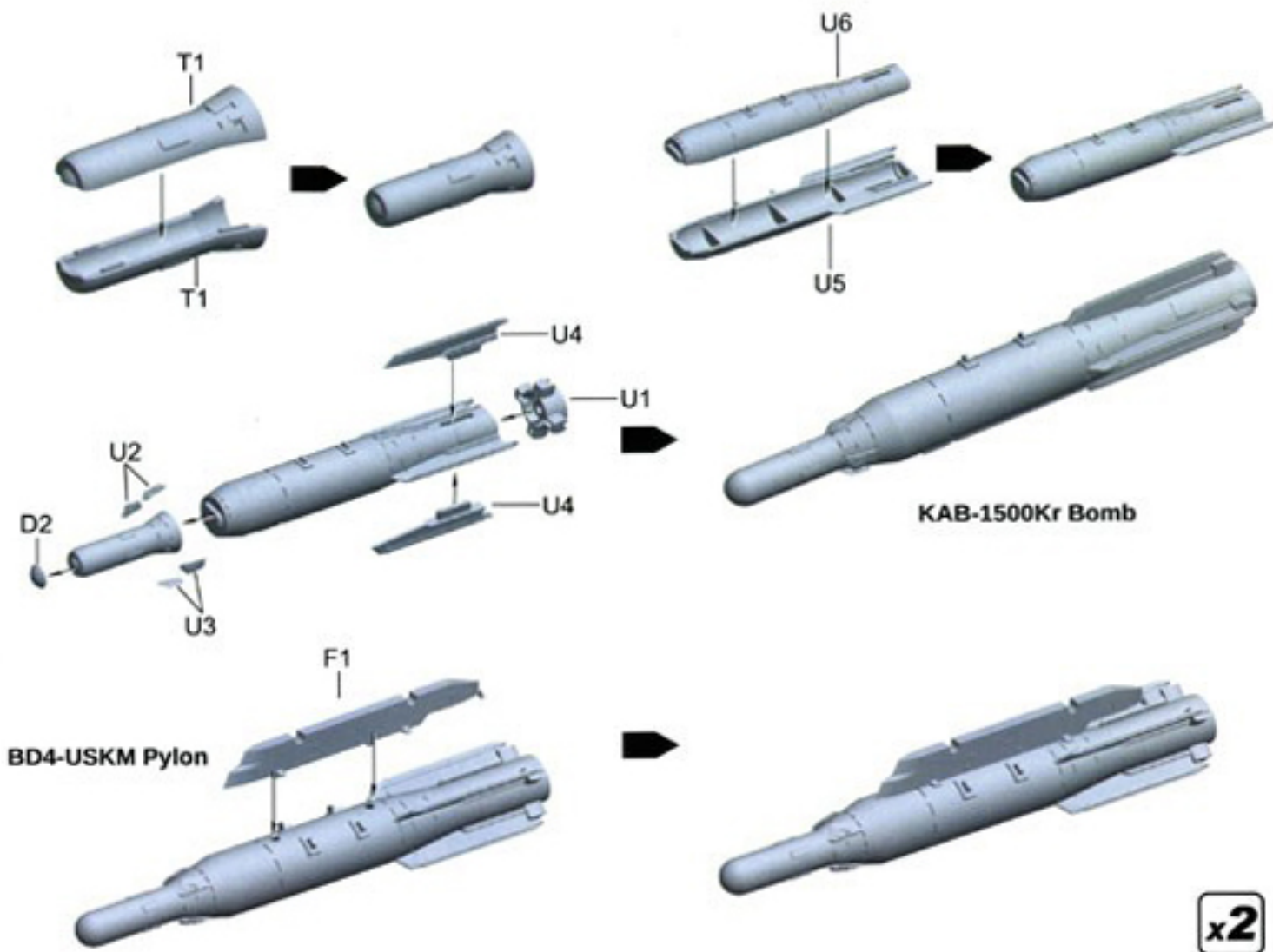

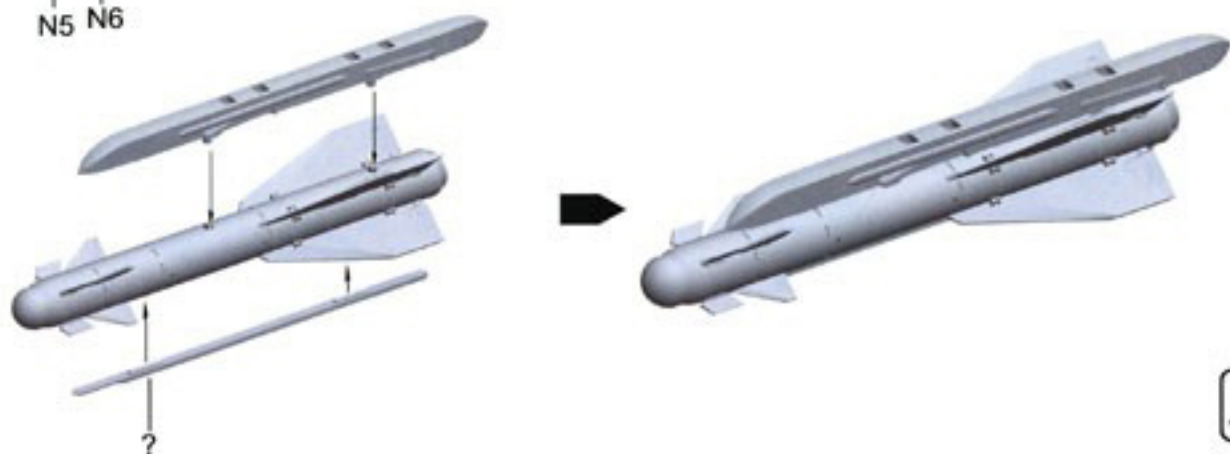
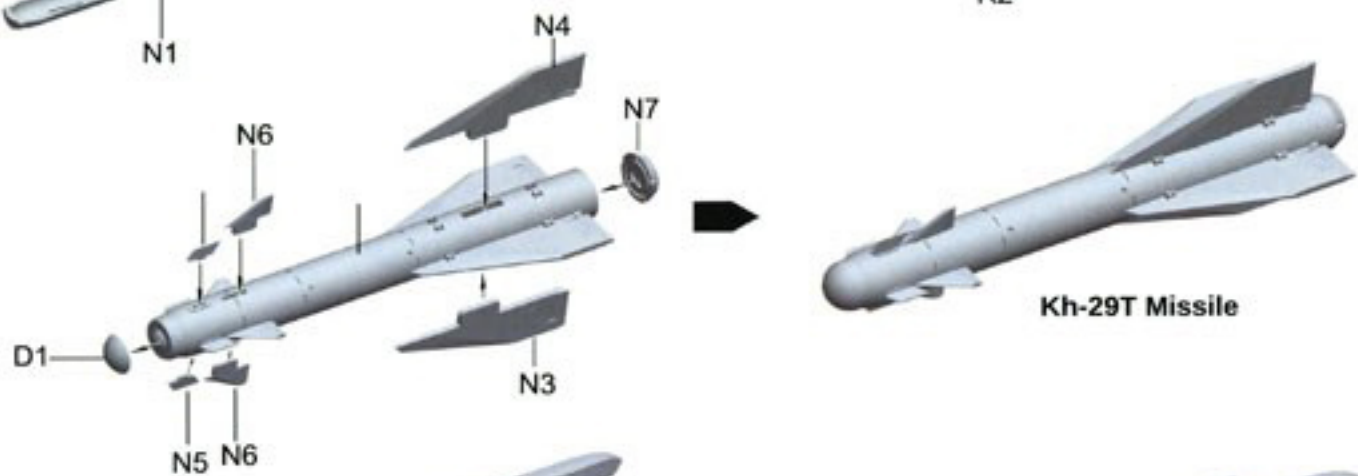

x2

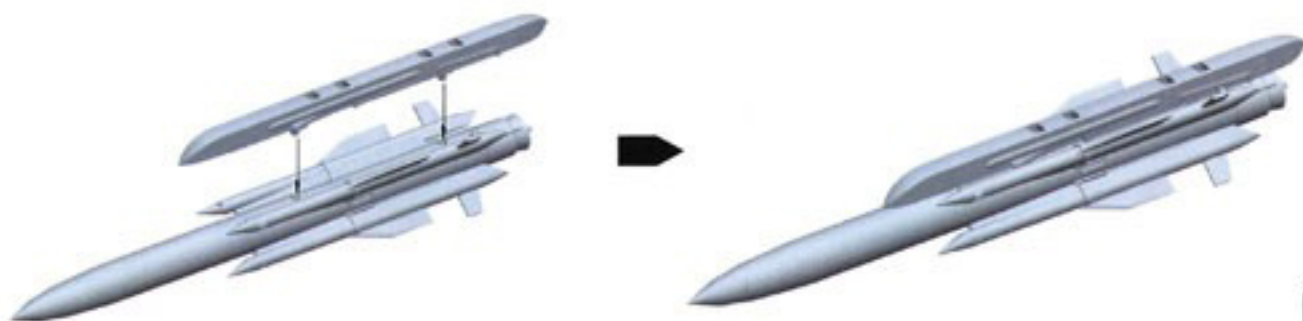
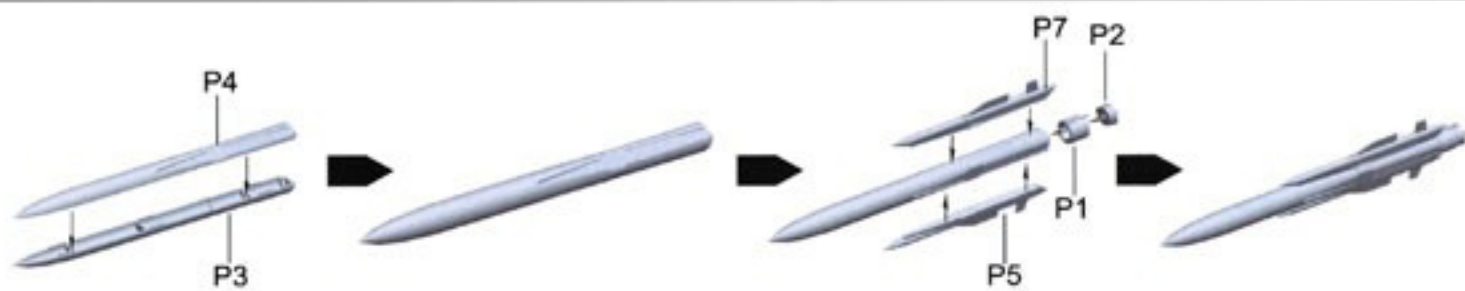

x2

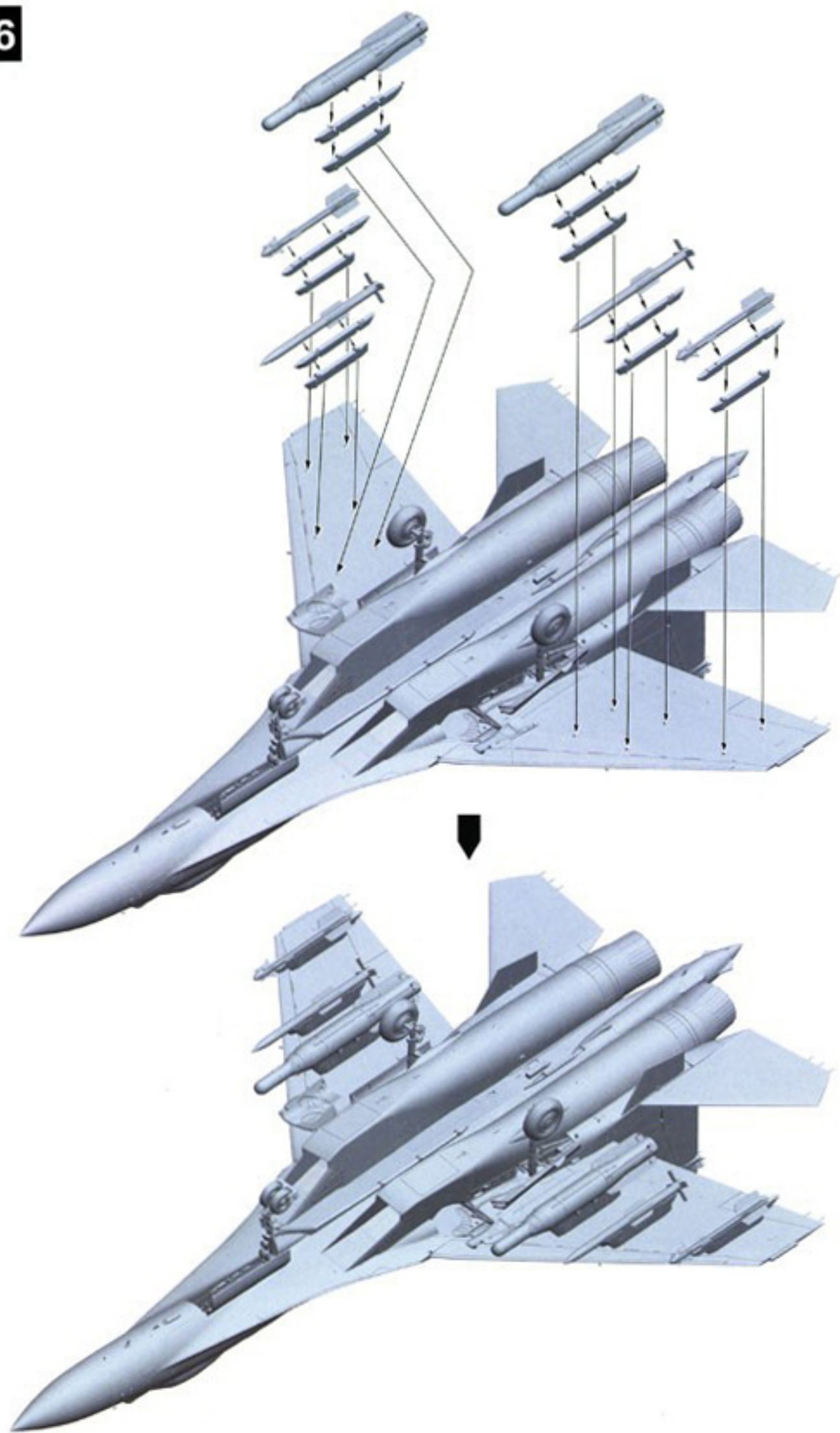

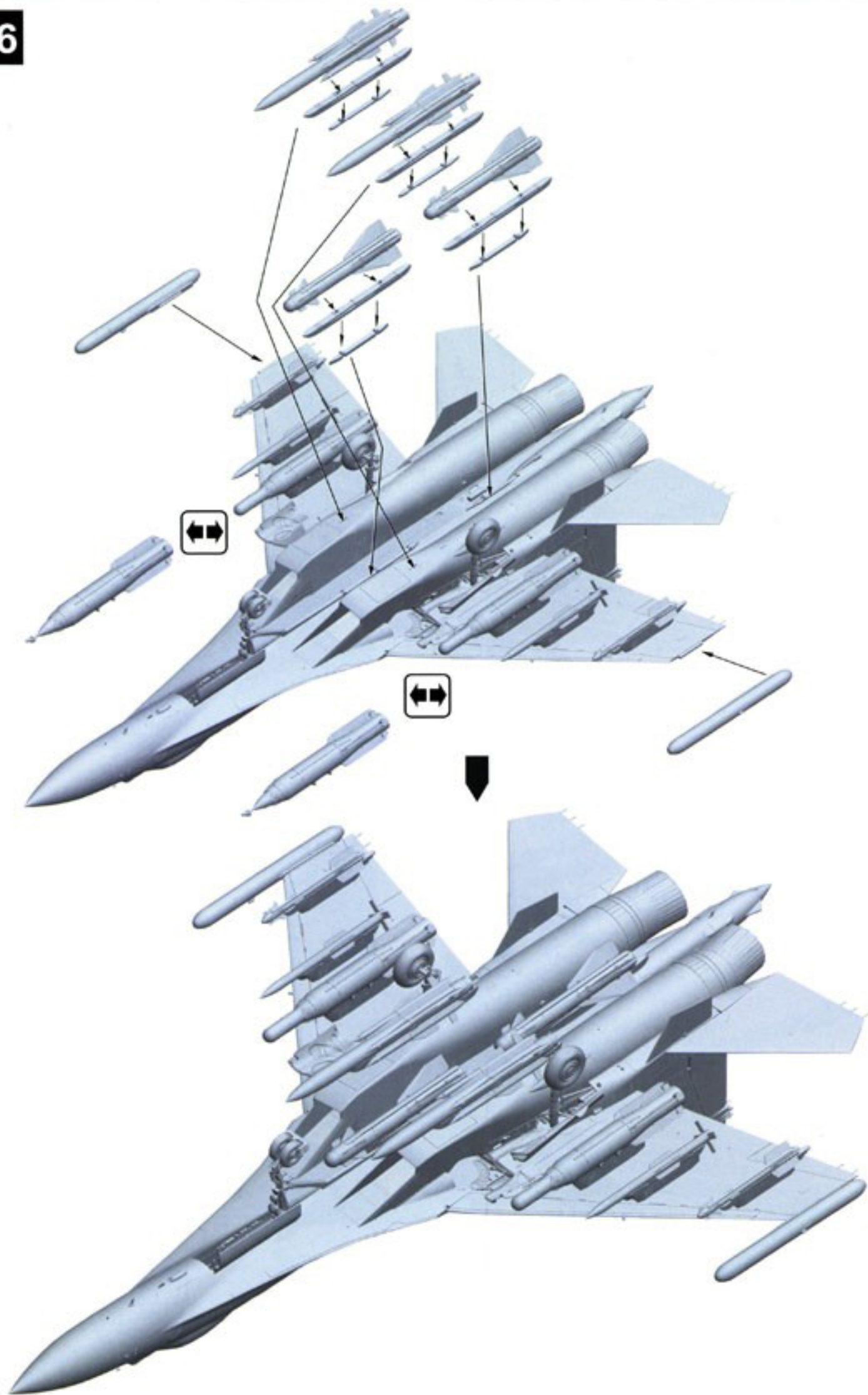



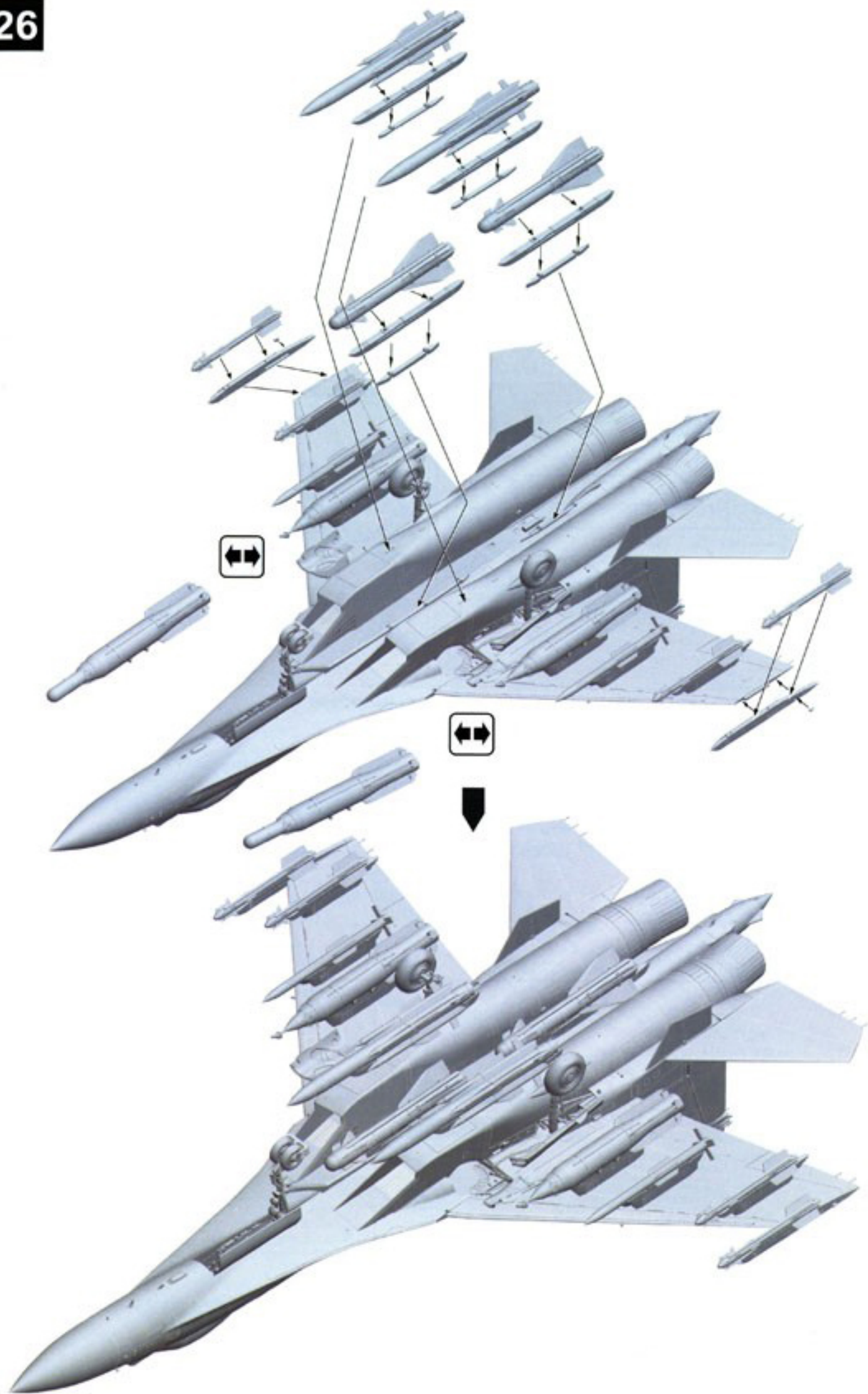

P-72



x2

APU-470

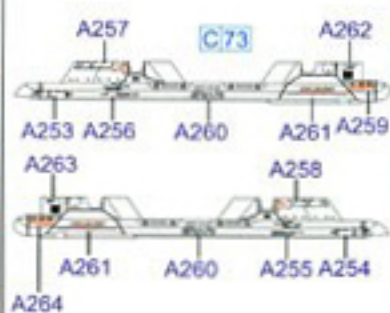

x4

AKU-170



x4

ADAPTOR

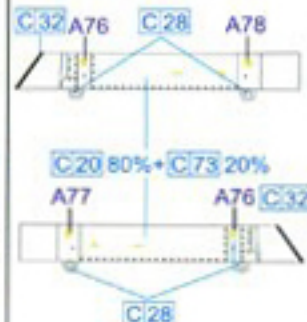

x6

L 265M10 Khibiny-M(L)

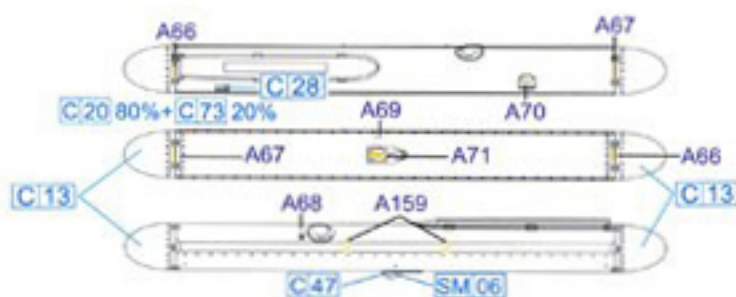

L 265M10 Khibiny-M(R)

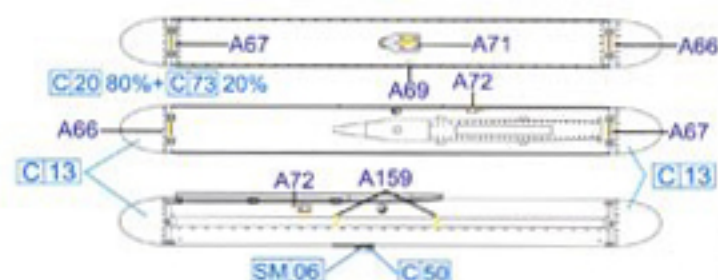

Wingtip P-72(L)



Wingtip P-72(R)

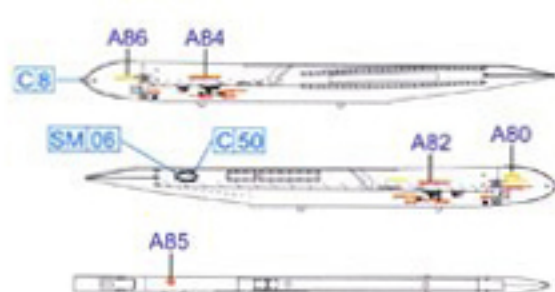

R-27ER

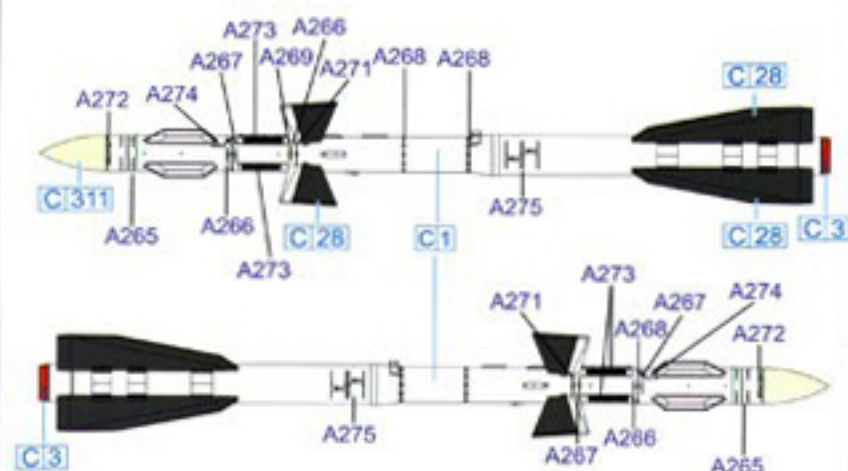

x2

R-73

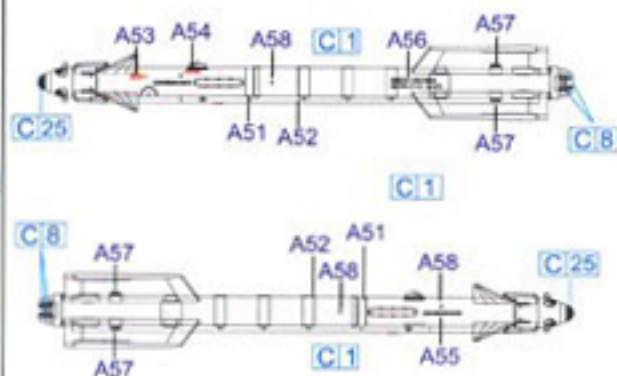

x4

## Kh-31AD Missile

侧面  
Side view

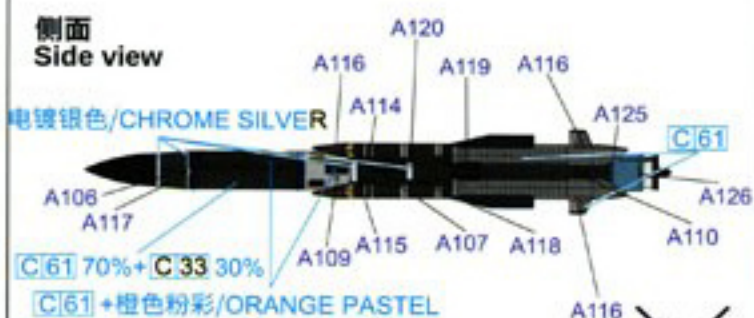

顶面  
Top view



## KAB-1500Kr

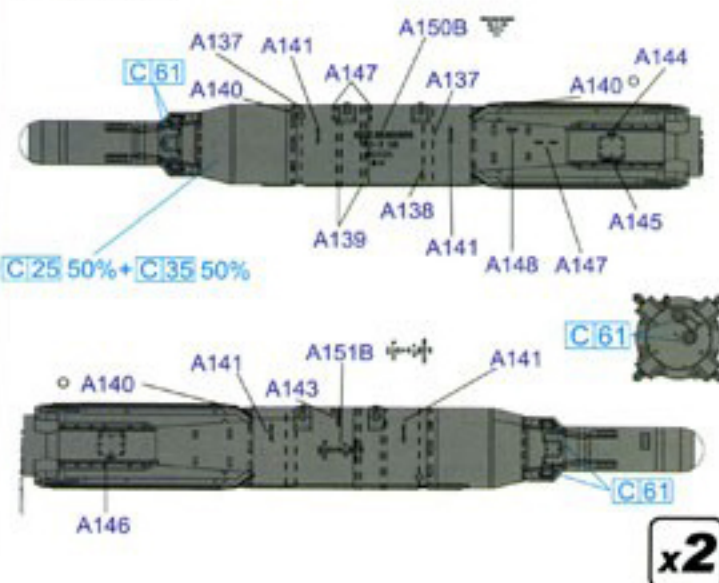

## BD4-USKM Pylon

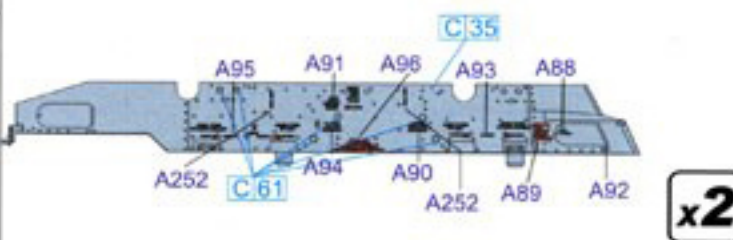
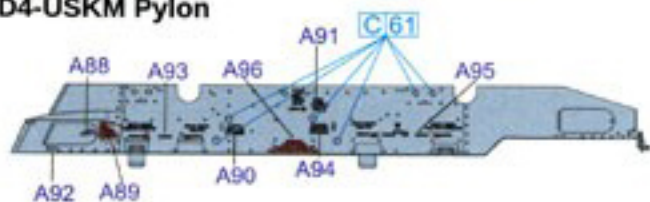

## KAB-1500L

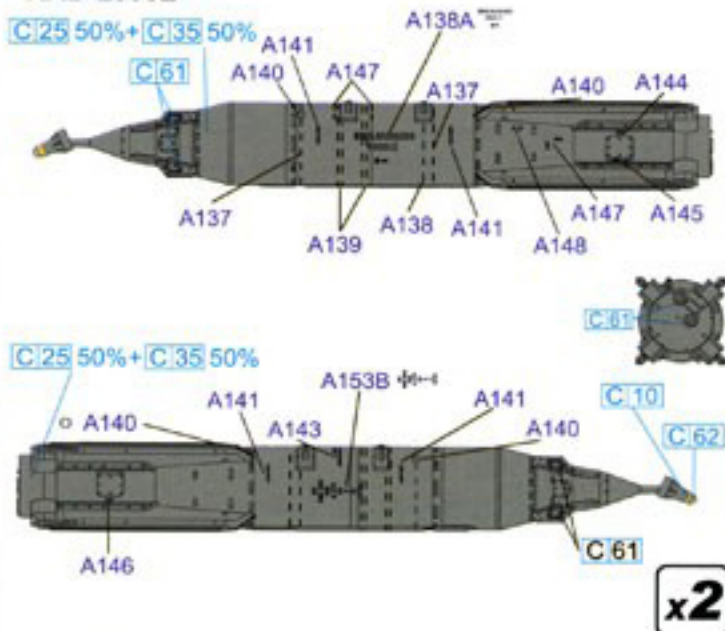

## Adaptor Pylon

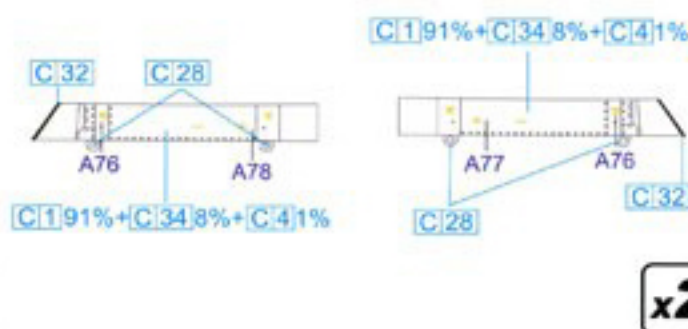

## AKU-58 Pylon

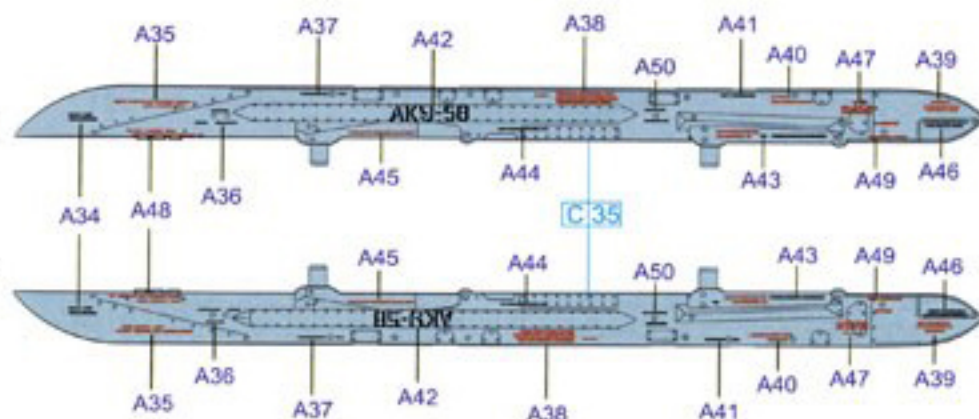

Kh-29T Missile(8924)

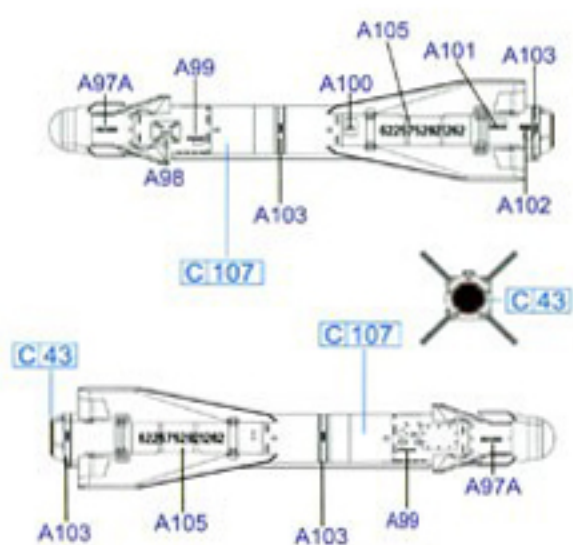

Kh-29T Missile(8942)

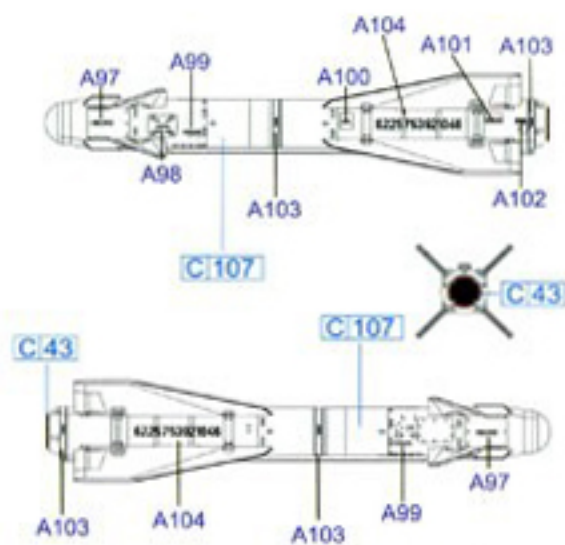

R-73 Missile

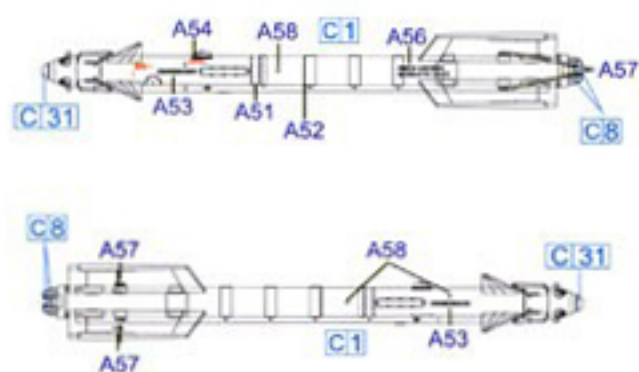

R-77 Missile

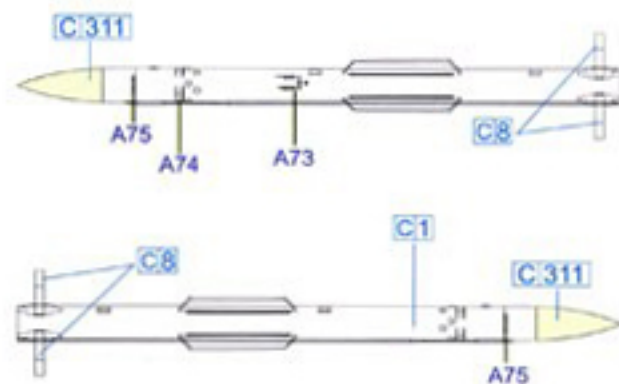

R-27ET

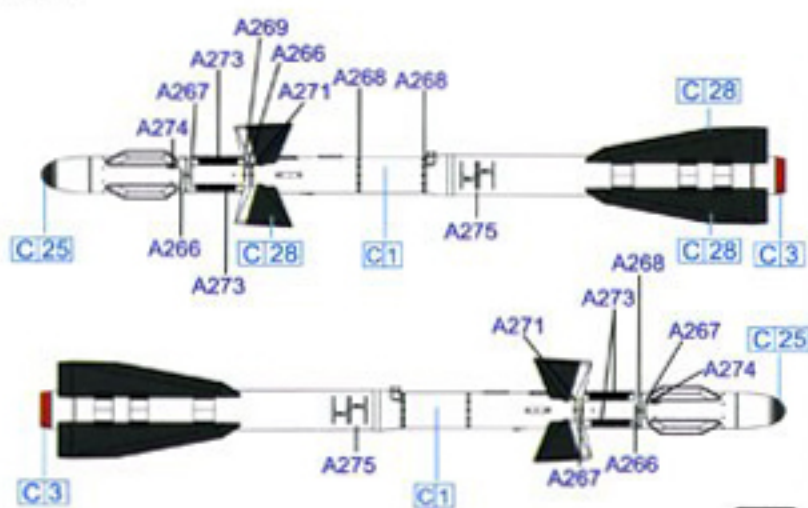

R-77

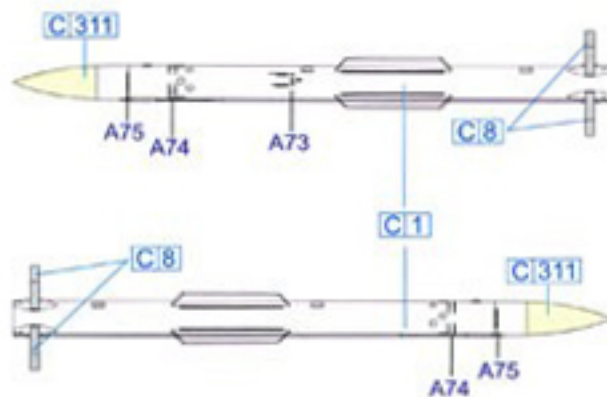

x2

x4

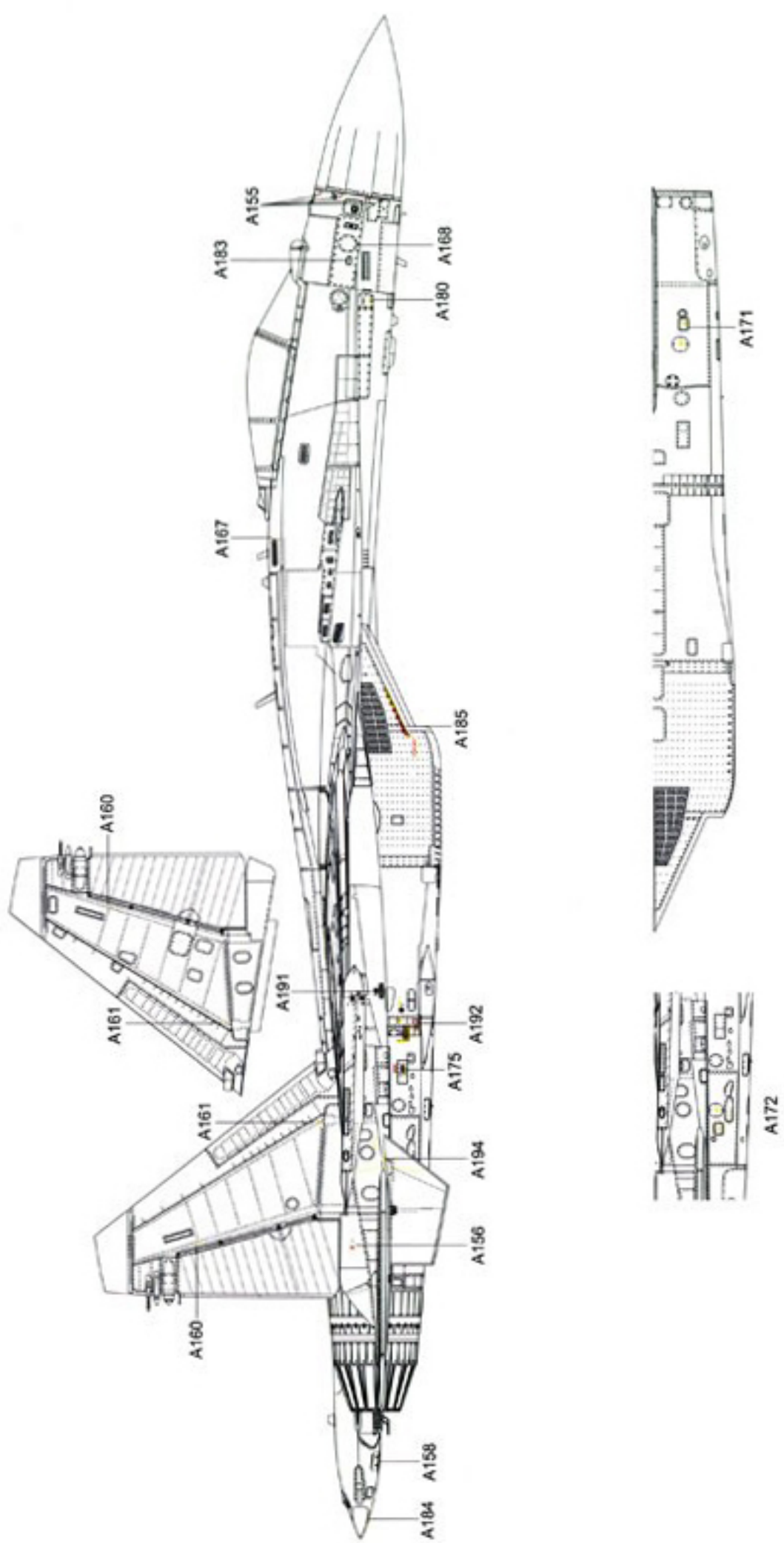

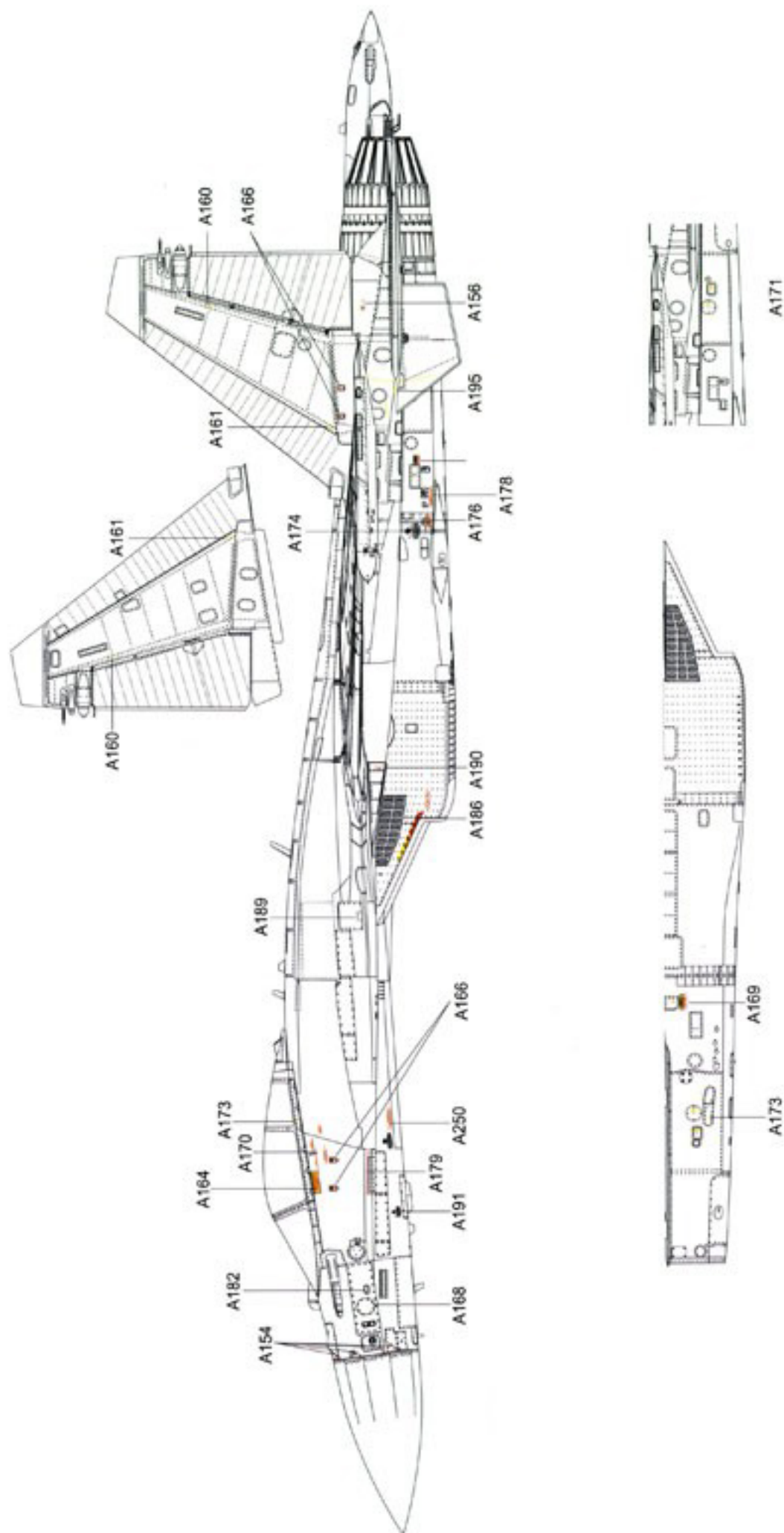

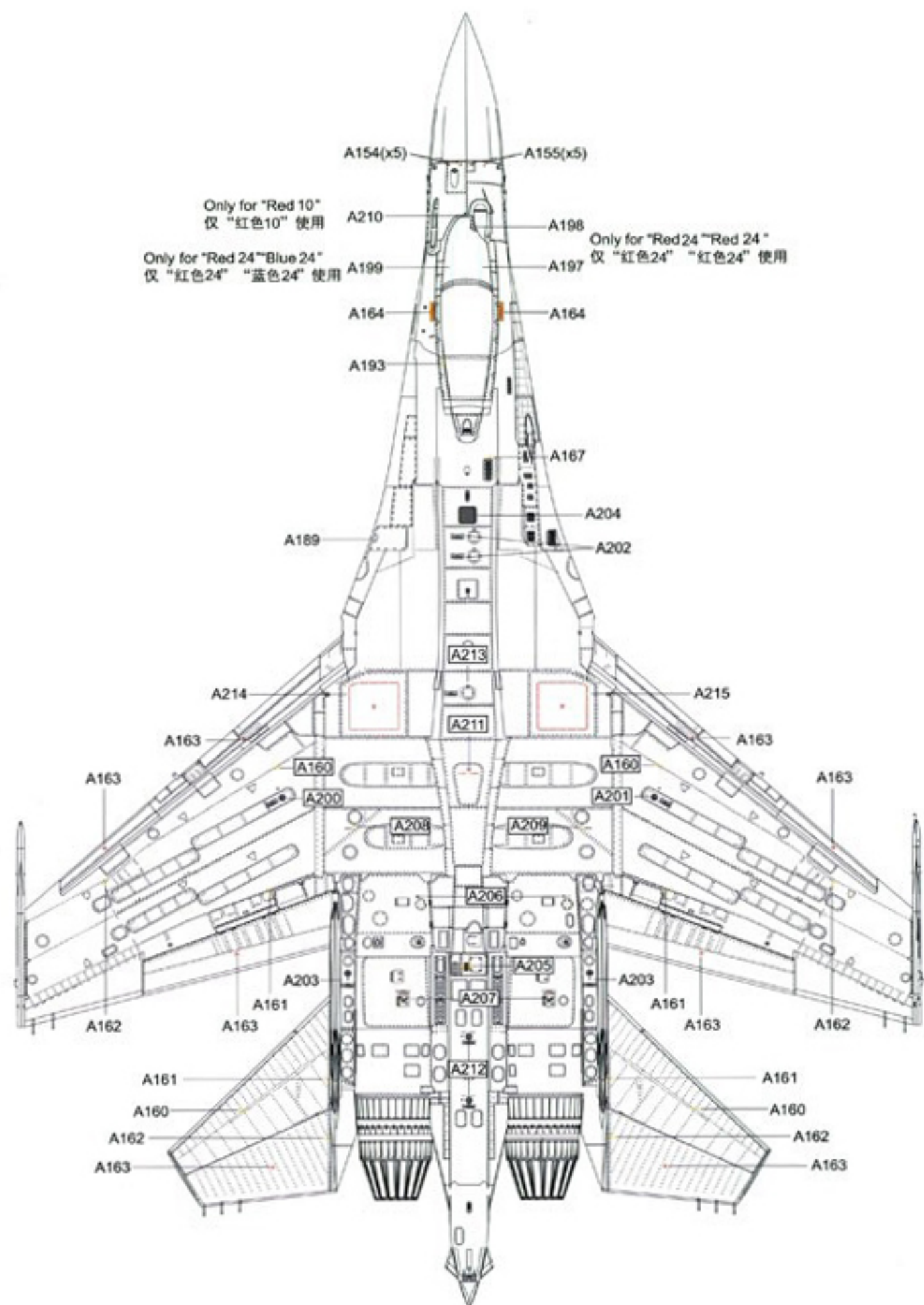

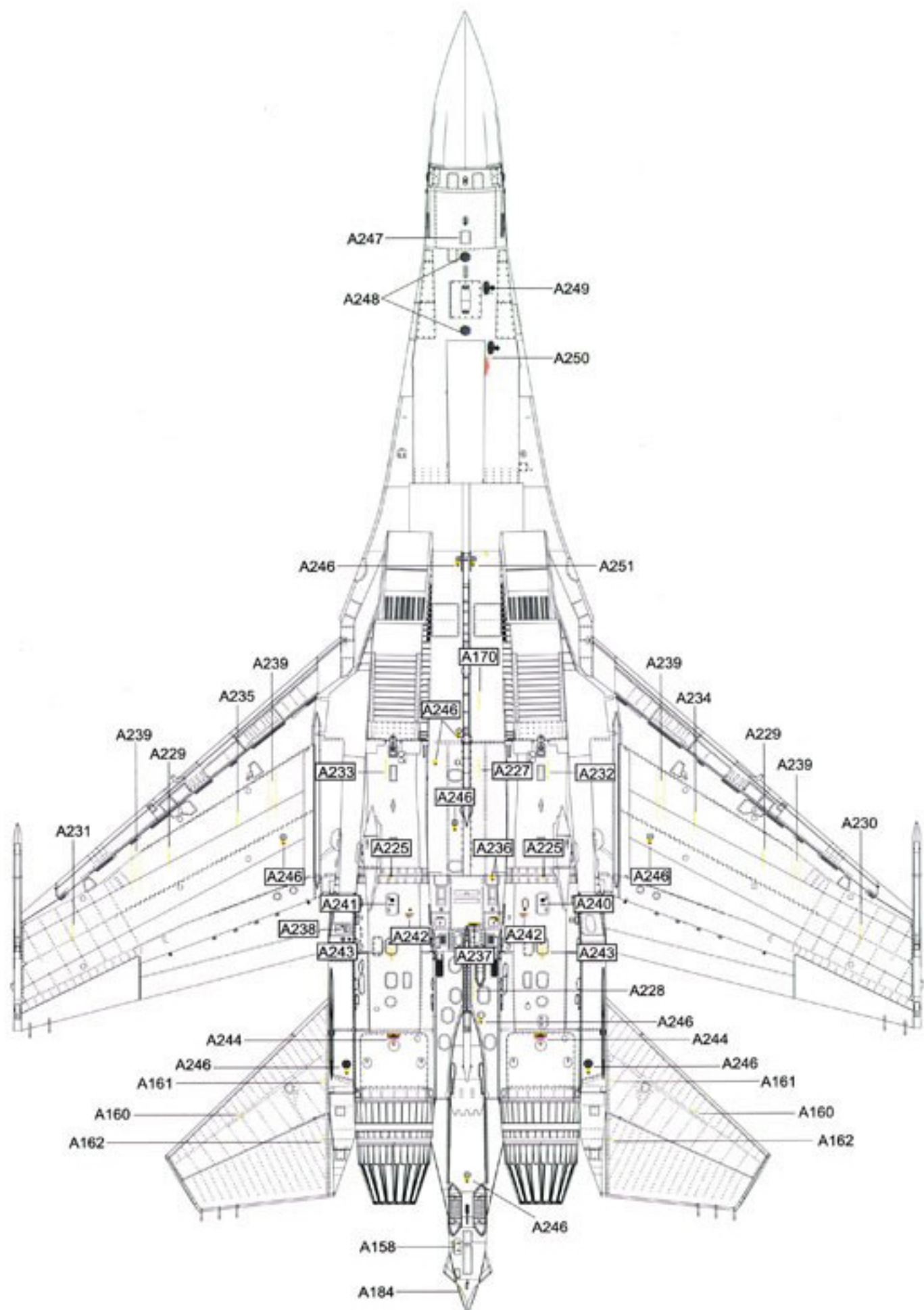





**A** RF-93651 "Red 10" 23rd IAP, 303rd Composite Aviation Division, 11th Army, VKS.

A: 70% C115 + 30% C1



**B** RF-95816 "Red 24" 23th IAP, 25th DPVO, 11th Air Army, Russian Aero-Cosmic Forces (VKS) MAKS 2017

A: 80% C20 + 20% C73  
 B: 10% C65 + 90% C73

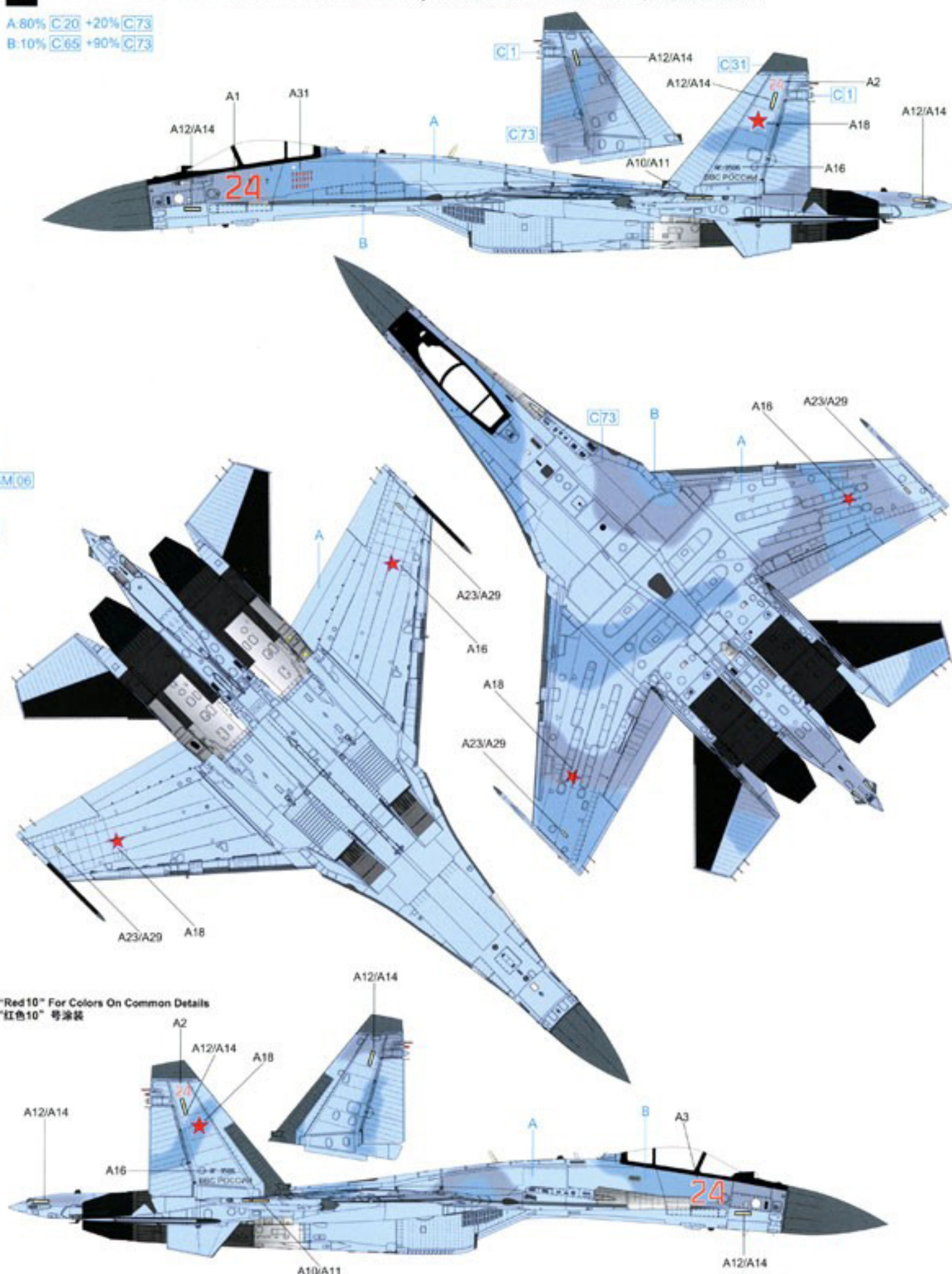

**!** Please Refer To Scheme "Red 10" For Colors On Common Details  
 通用细节颜色请参考“红色10”号涂装

G.W.H

# SU-35S "FLANKER-E"

MULTIROLE FIGHTER Su-35S "侧卫-E" 多用途战斗机



1/72 SCALE AIRCRAFT L7210

涂装指示 PAINTING カラーガイド

**C** RF-95867 "Red 25" named after "Hero of Soviet Union" Ivan Gorbunov 23th IAP, 25th DPVO, 11th Air Army, Russian Aero-Cosmic Forces (VKS) Dzemgi, Russia 2016

A:80% C20 +20% C73  
B:10% C65 +90% C73

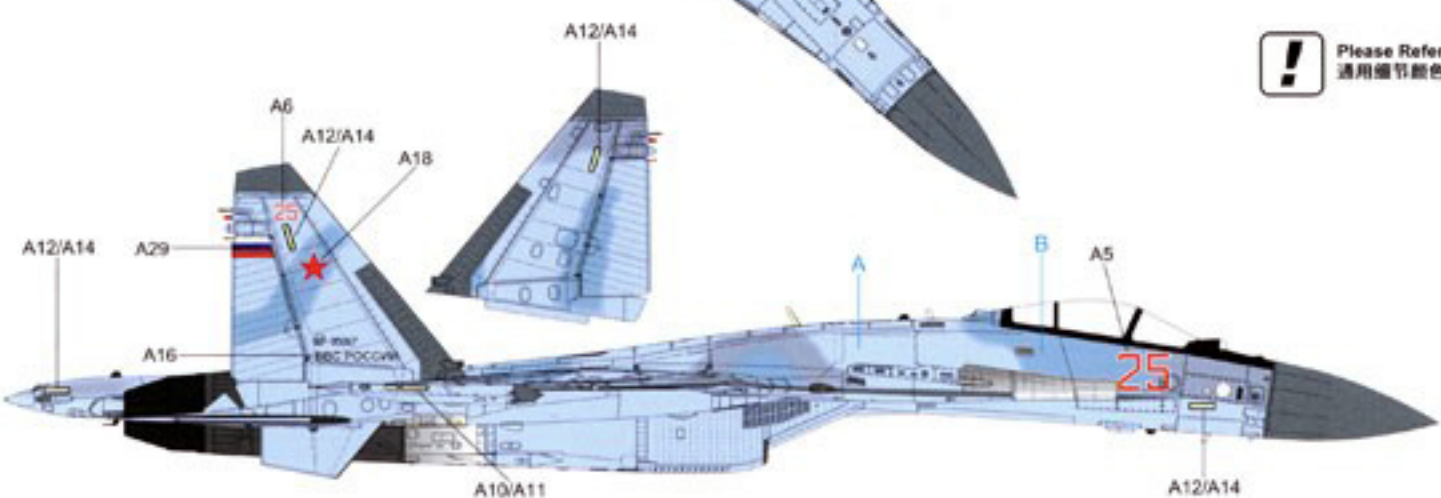
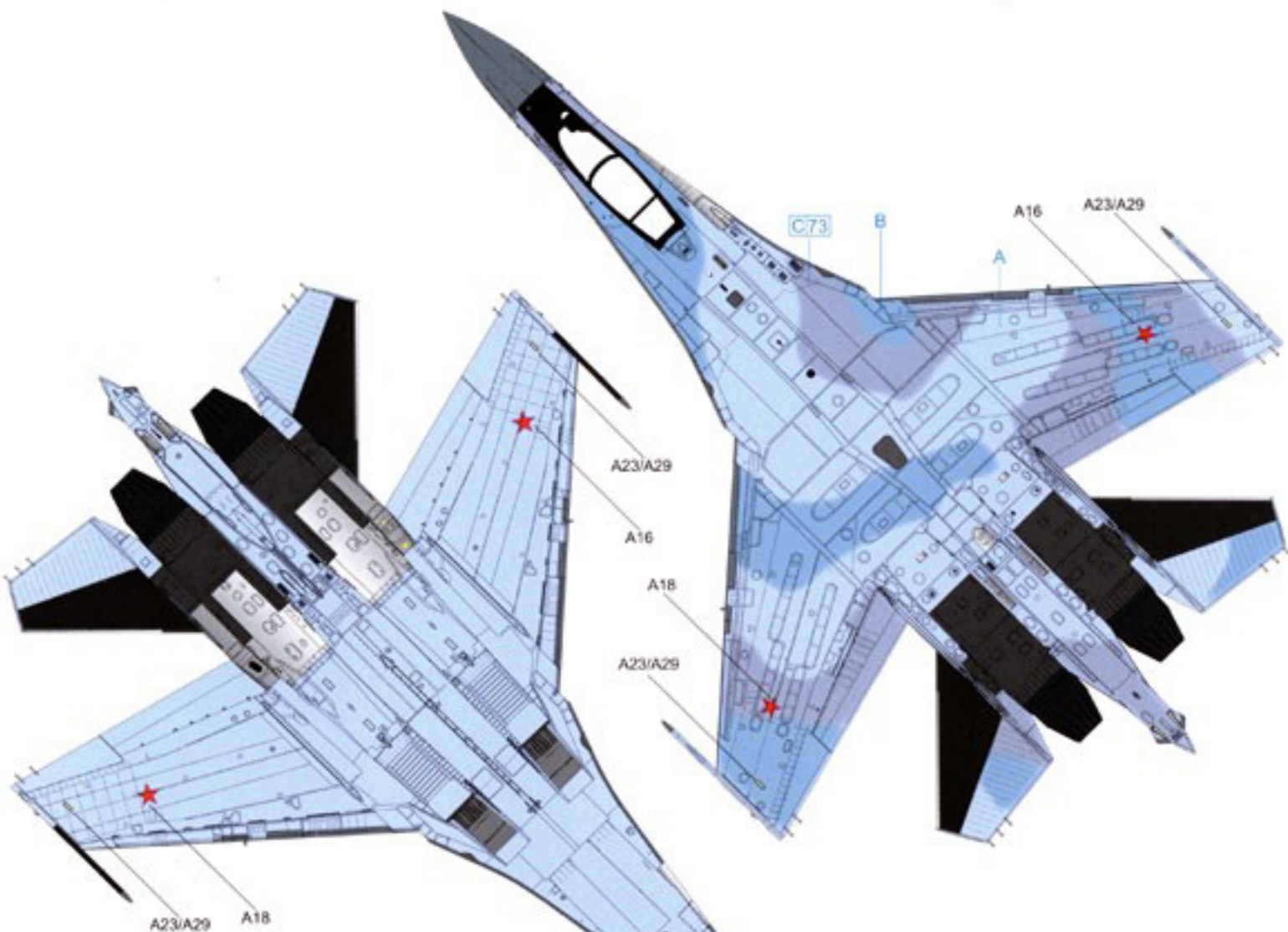
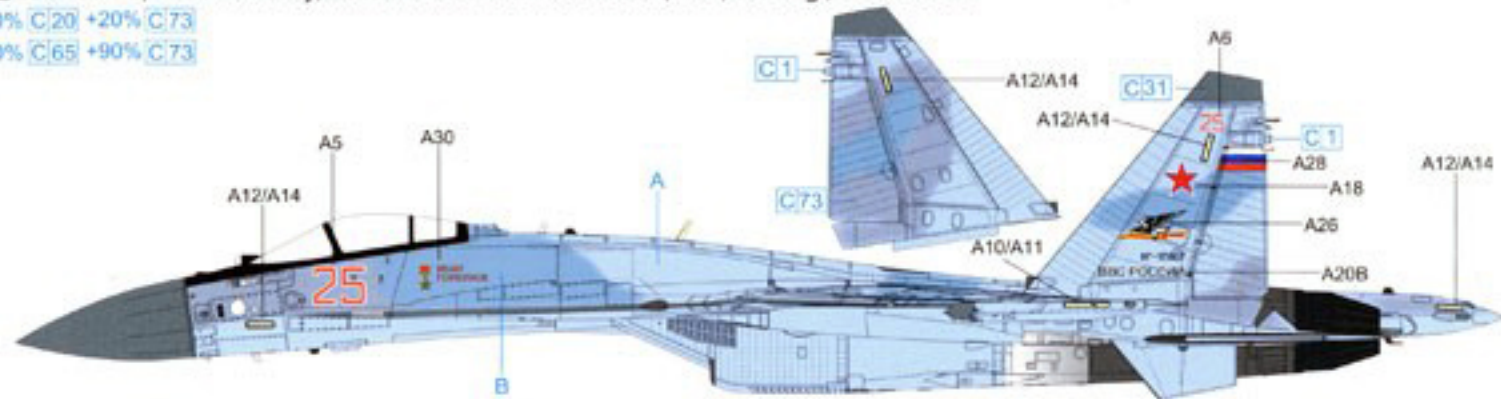

**D** RF-95493 "Blue 24" named after "Hero of Soviet Union" Ivan Gorbunov 22nd IAP, 23th KPVO, 11th Air Army, Russian Aero-Cosmic Forces (VKS) Dzemgi, Russia 2016

A:80% C20 +20% C73  
B:10% C65 +90% C73

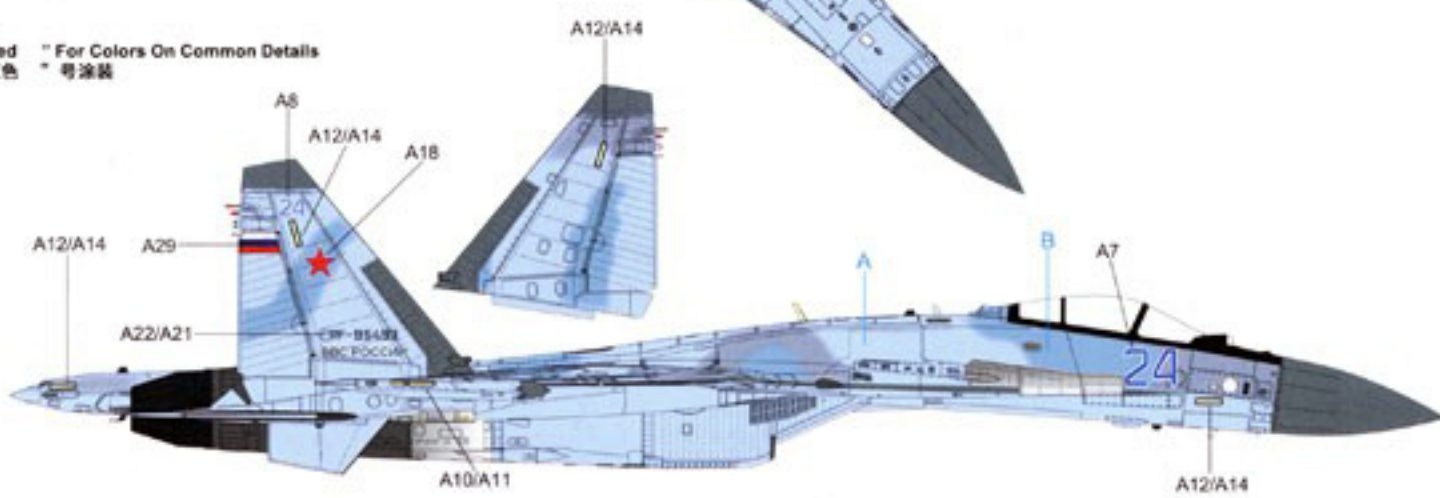
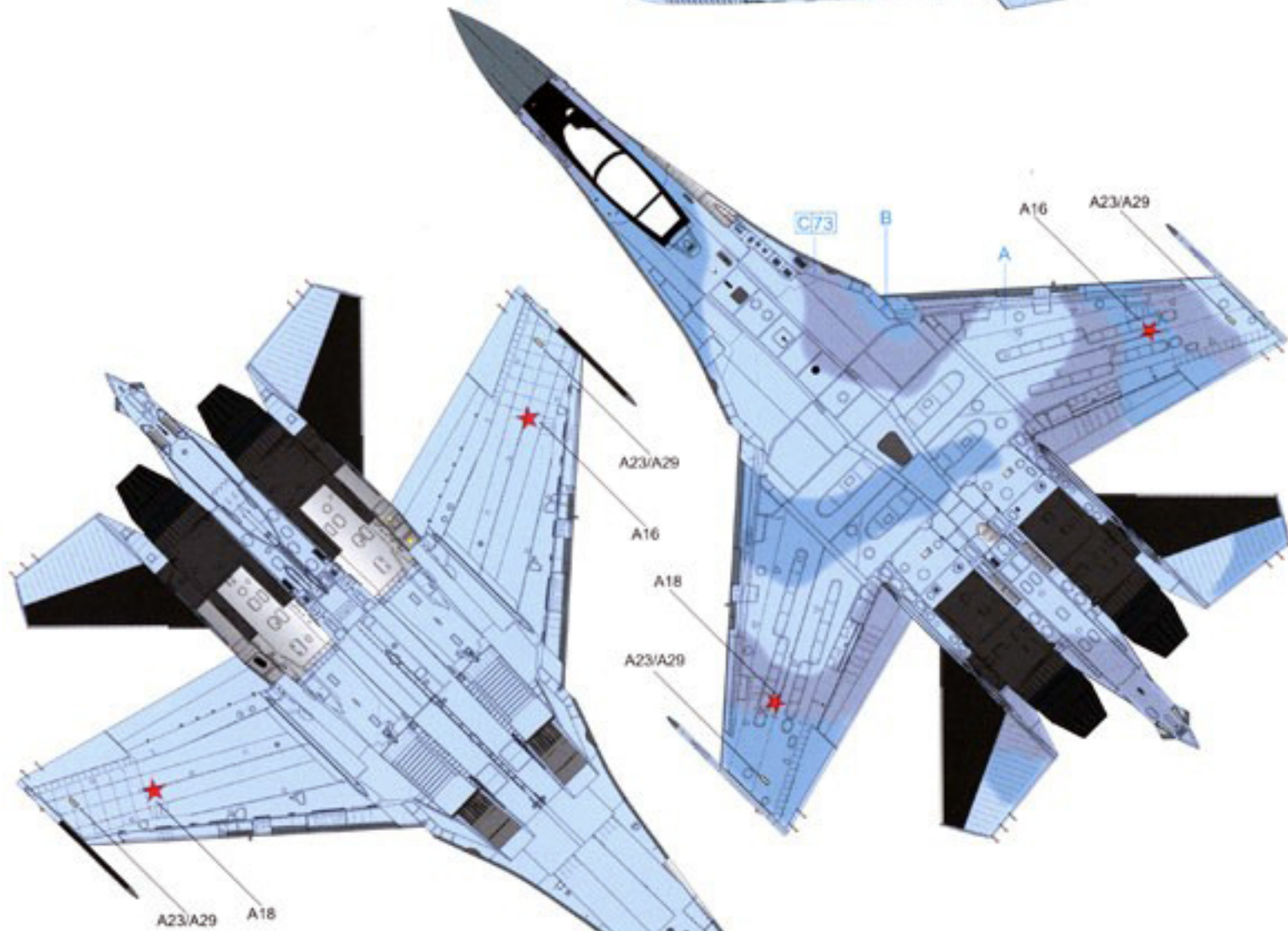
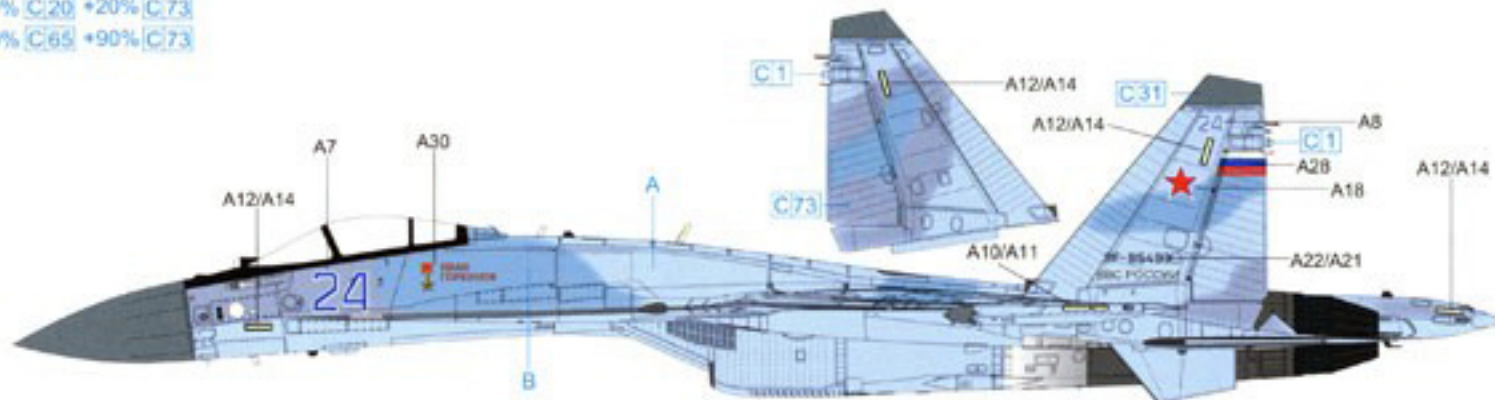

**!** Please Refer To Scheme "Red" For Colors On Common Details  
通用细节颜色涂装请参考 "红色" 号涂装