

1/35 MILITARY MINIATURE VEHICLE UPGRADE SERIES PE35834

# Russian T-54B Medium Tank basic

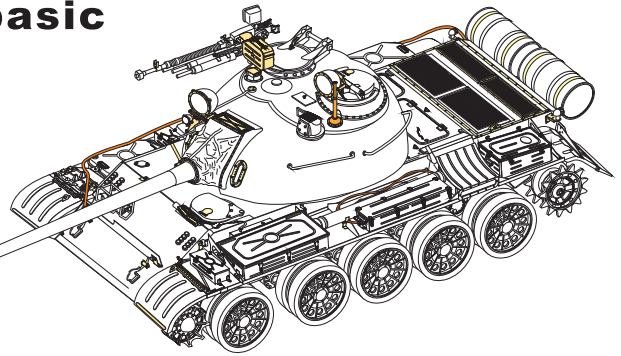



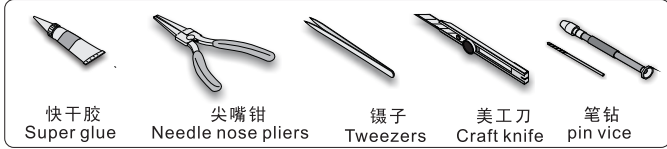

## 现代俄罗斯T-54B型主战坦克改造基本件

[For TAKOM 2055]





### 推荐使用工具 RECOMMENDED TOOLS

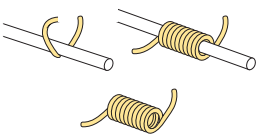

-   
 安装  
install
-   
 折叠  
bend
- A1**  
 改造件零件编号  
PE/resin part number
- B12**  
 原零件编号  
kit part number
- C22**  
 被替换的原零件编号  
replaced kit part number
-   
 切除  
remove
-   
 弧度卷曲  
radial bending
- x2**  
 制作若干组  
multiple assembly
-   
 选择安装  
alternative
-   
 另一侧相同制作  
repeat on opposite side

 制作线圈  
make coil



 用尖端在凹槽处冲压  
use penpoint to press on the dent

蚀刻片零件内侧面向上  
Put the part upside down

用笔尖在凹槽处刺  
Use penpoint to press on the dent

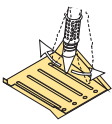

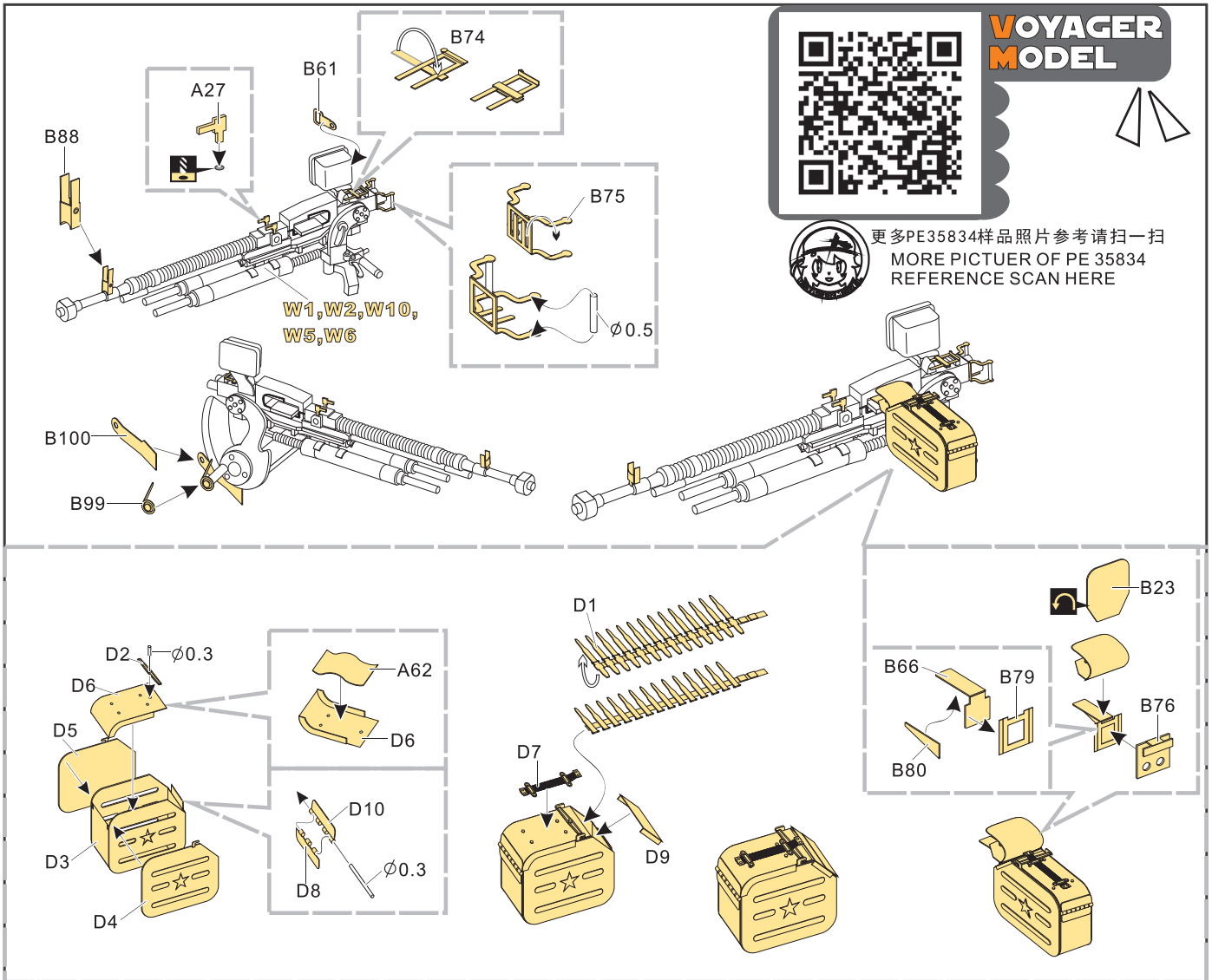

1/35 MILITARY MINIATURE VEHICLE UPGRADE SERIES PE35834



1/35 MILITARY MINIATURE VEHICLE UPGRADE SERIES PE35834

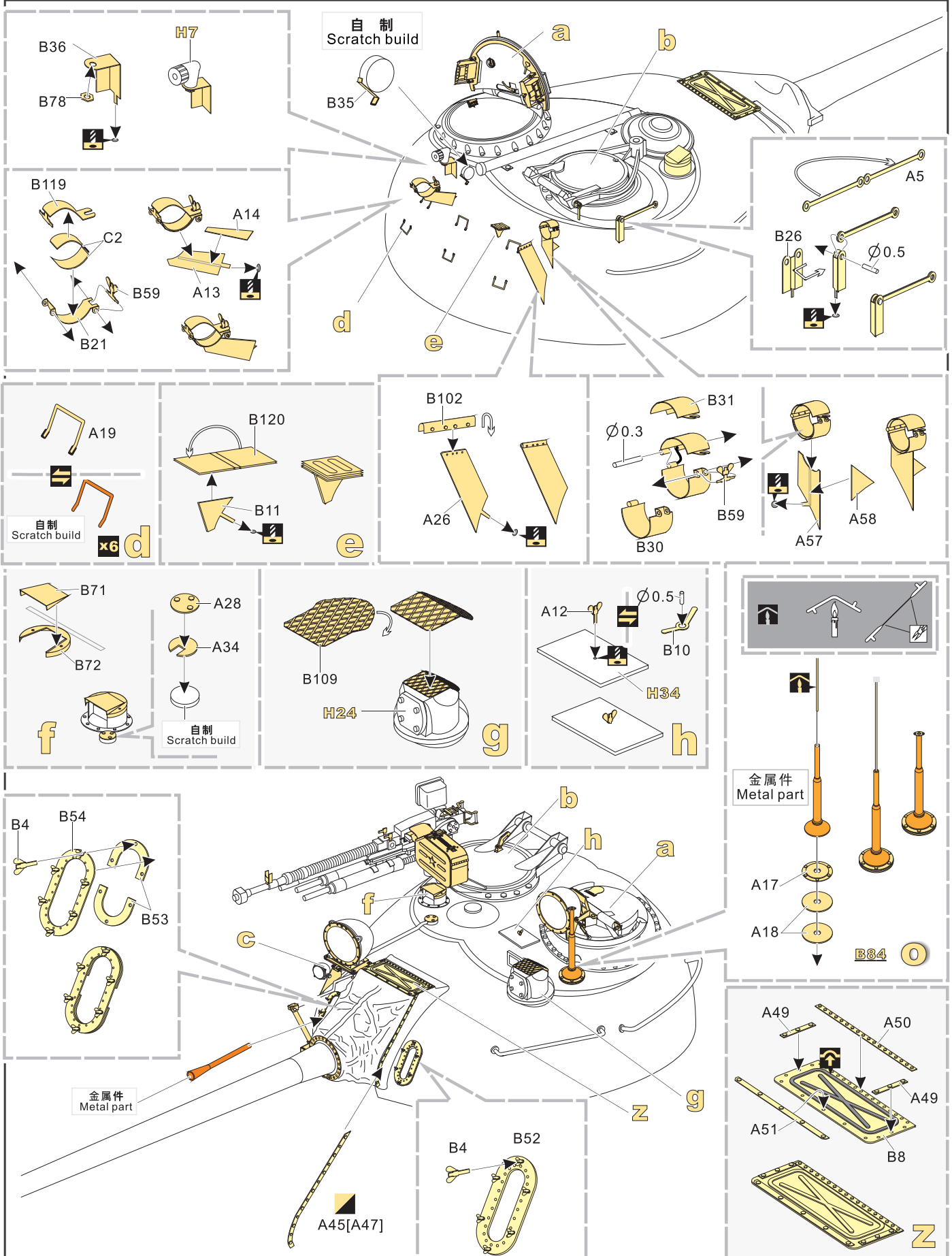

1/35 MILITARY MINIATURE VEHICLE UPGRADE SERIES PE35834

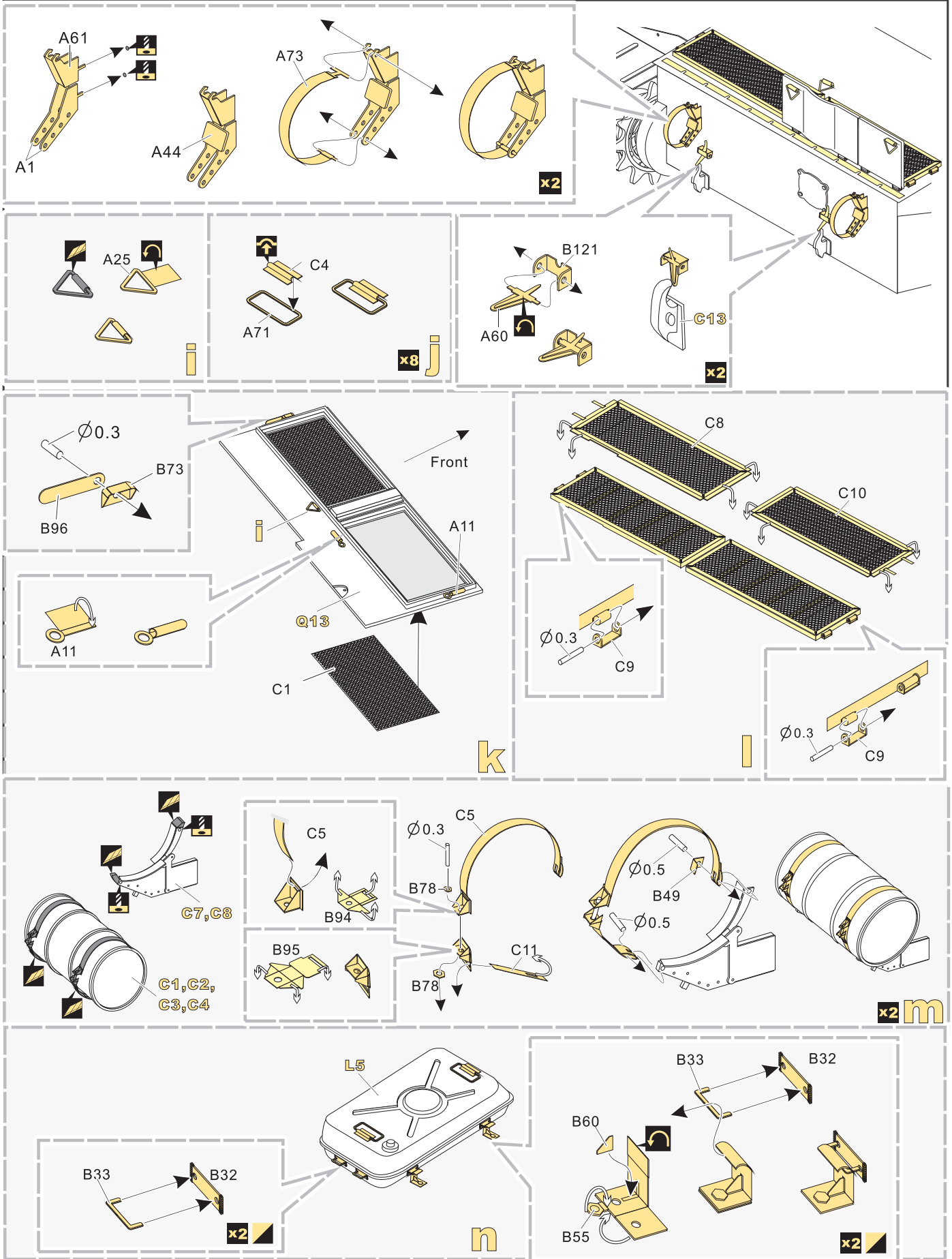

1/35 MILITARY MINIATURE VEHICLE UPGRADE SERIES PE35834

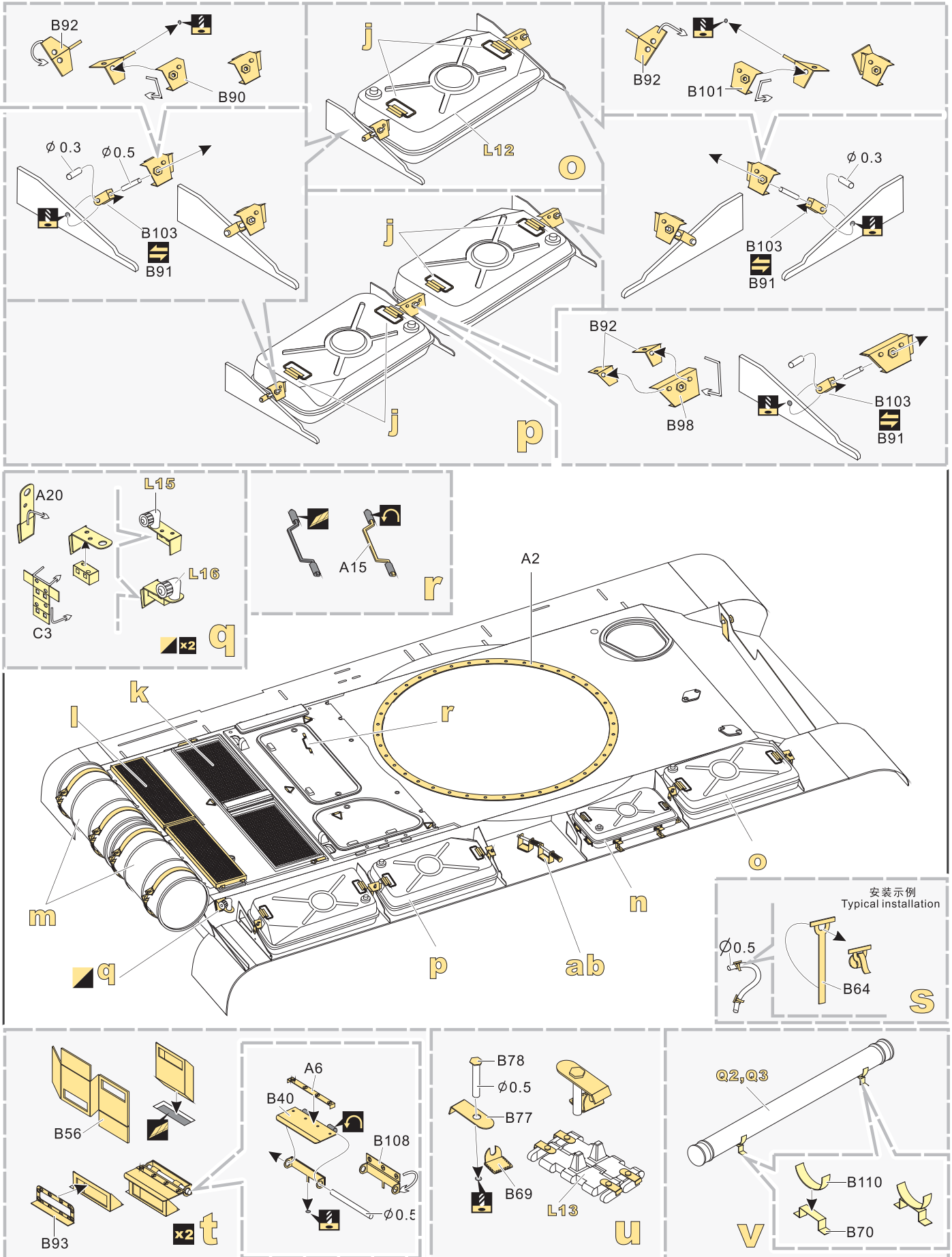

1/35 MILITARY MINIATURE VEHICLE UPGRADE SERIES PE35834

