

DETAIL AFTER REMOVAL FROM SPRUES

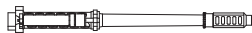

R2

USE A SAW TO REMOVE SUPPORTS
FROM 3D PRINTED PARTS

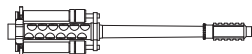
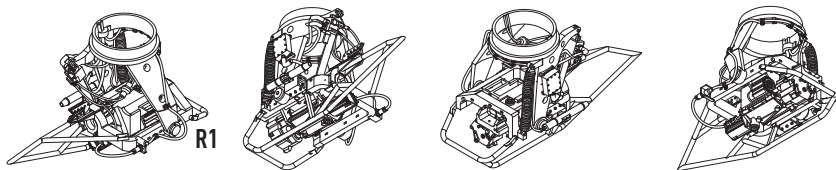
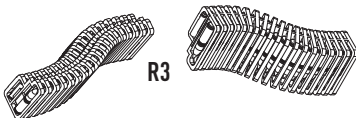

R3

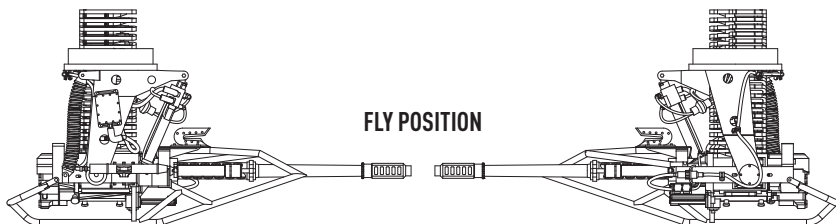
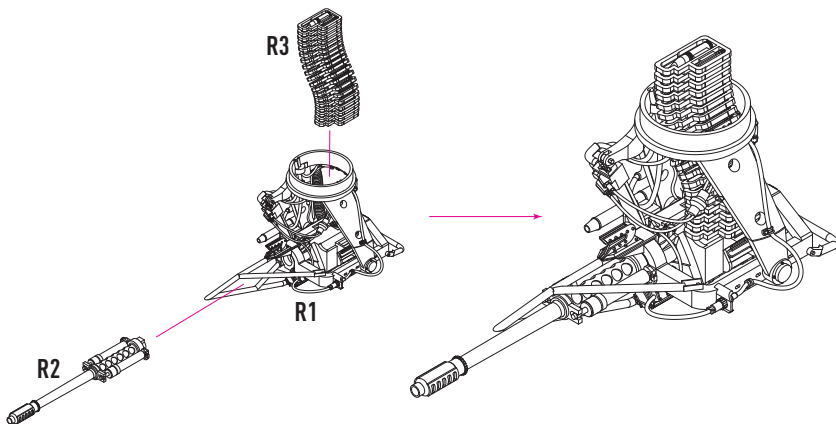

FLY POSITION

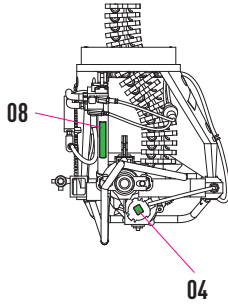
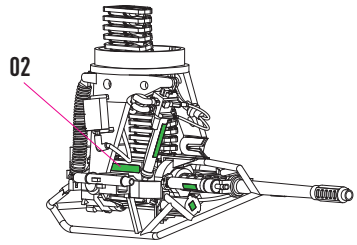
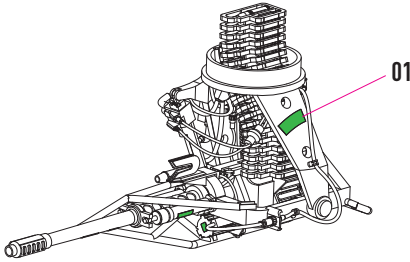
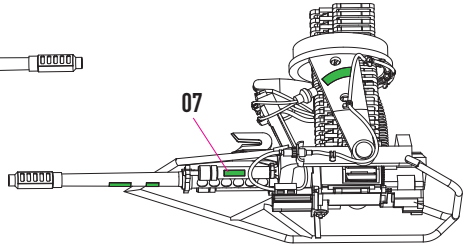
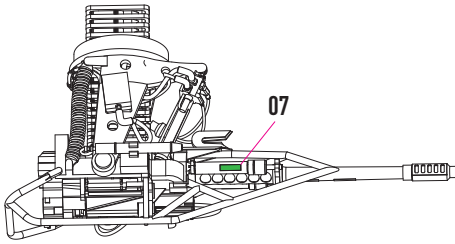

04

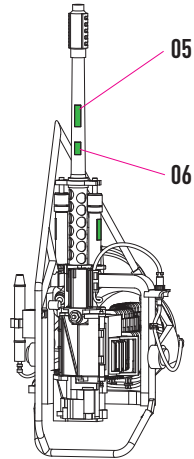
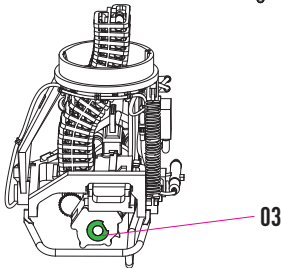

06