



B-17G waist section

eduard

49 1062

1/48

detail set for HKM 1/48 kit • sada detailů pro stavebnici HKM 1/48

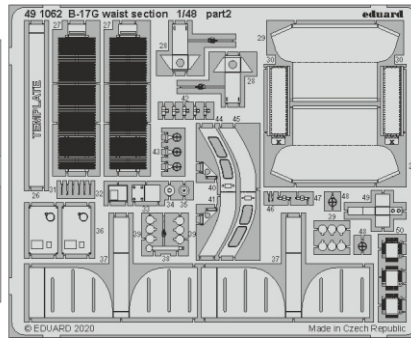
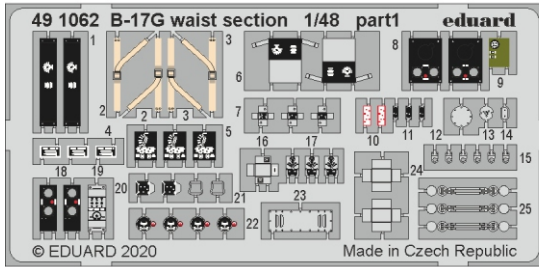

- APPLY EXPRESS MASK AND PAINT BEFORE GLUING
POUŽIT EXPRESS MASK NABARVIT PŘED SLEPENÍM
 - SYMMETRICAL ASSEMBLY
SYMETRICKÁ MONTÁŽ
 - REMOVE
ODSTRANIT
 - GRIND
OBROUSIT
 - DRILL HOLE
VRTAT OTVOR
 - COLORED ETCHED PARTS
LEPTANÉ BAREVNÉ DÍLY
 - ETCHED PARTS
LEPTANÉ NEBAREVNÉ DÍLY
 - ORIGINAL KIT PARTS
PŮVODNÍ DÍLY STAVEBNICE
- BEND
OHNOUT
 - OPTION
VOLBA
 - REPLACE
NAHRADIT

ORIGINAL KIT PARTS
PŮVODNÍ DÍLY STAVEBNICE

PHOTO-ETCHED PARTS
LEPTANÉ DÍLY

PARTS TO BE REMOVED
DÍLY K ODSTRANĚNÍ

FILL
TMELIT

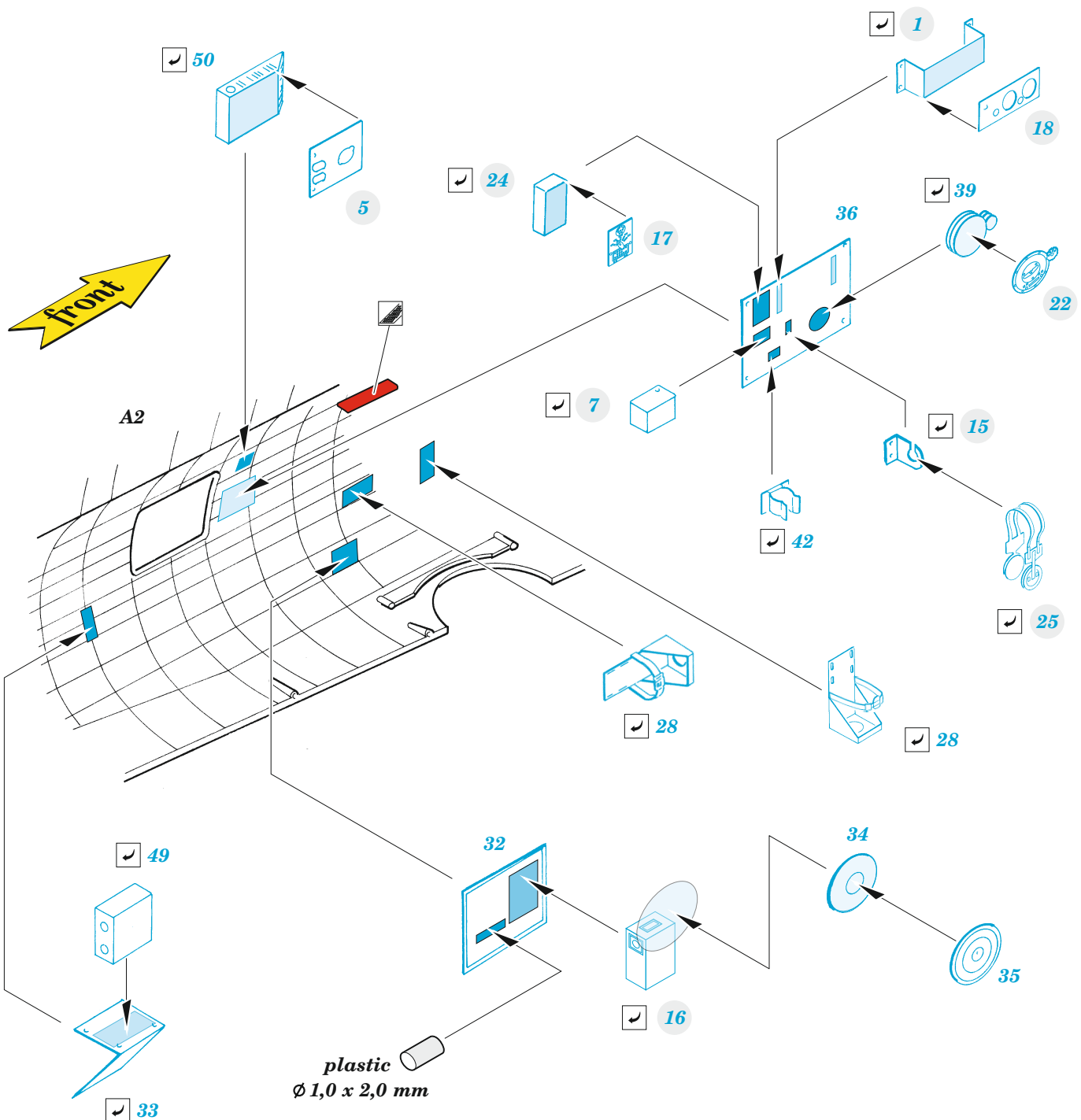

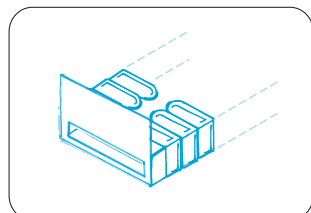
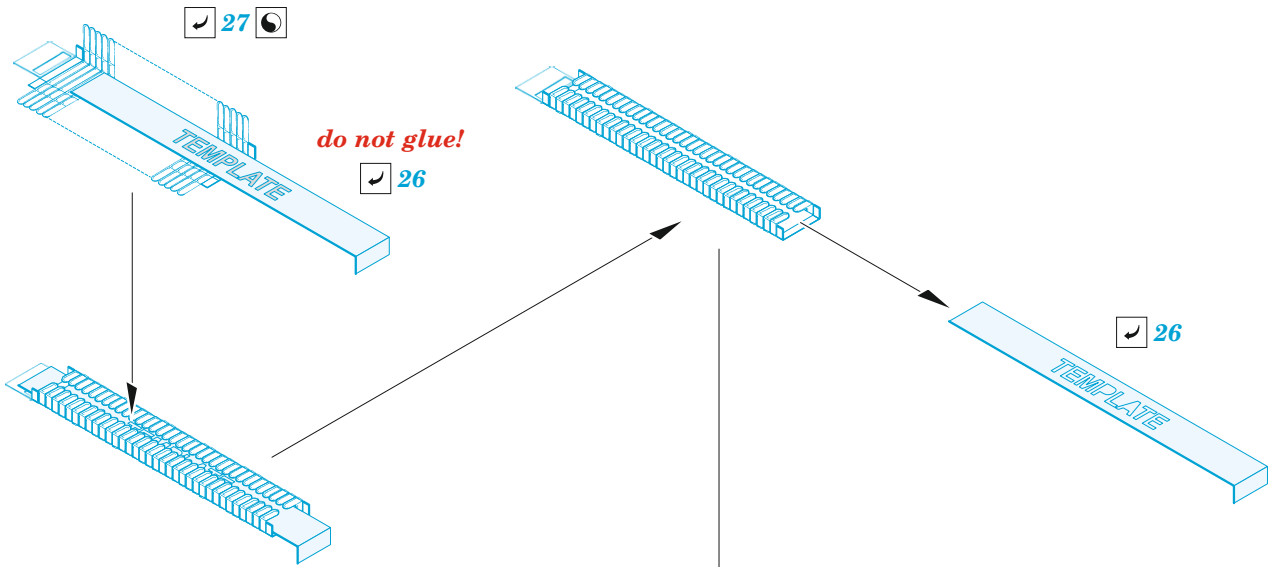

correct position

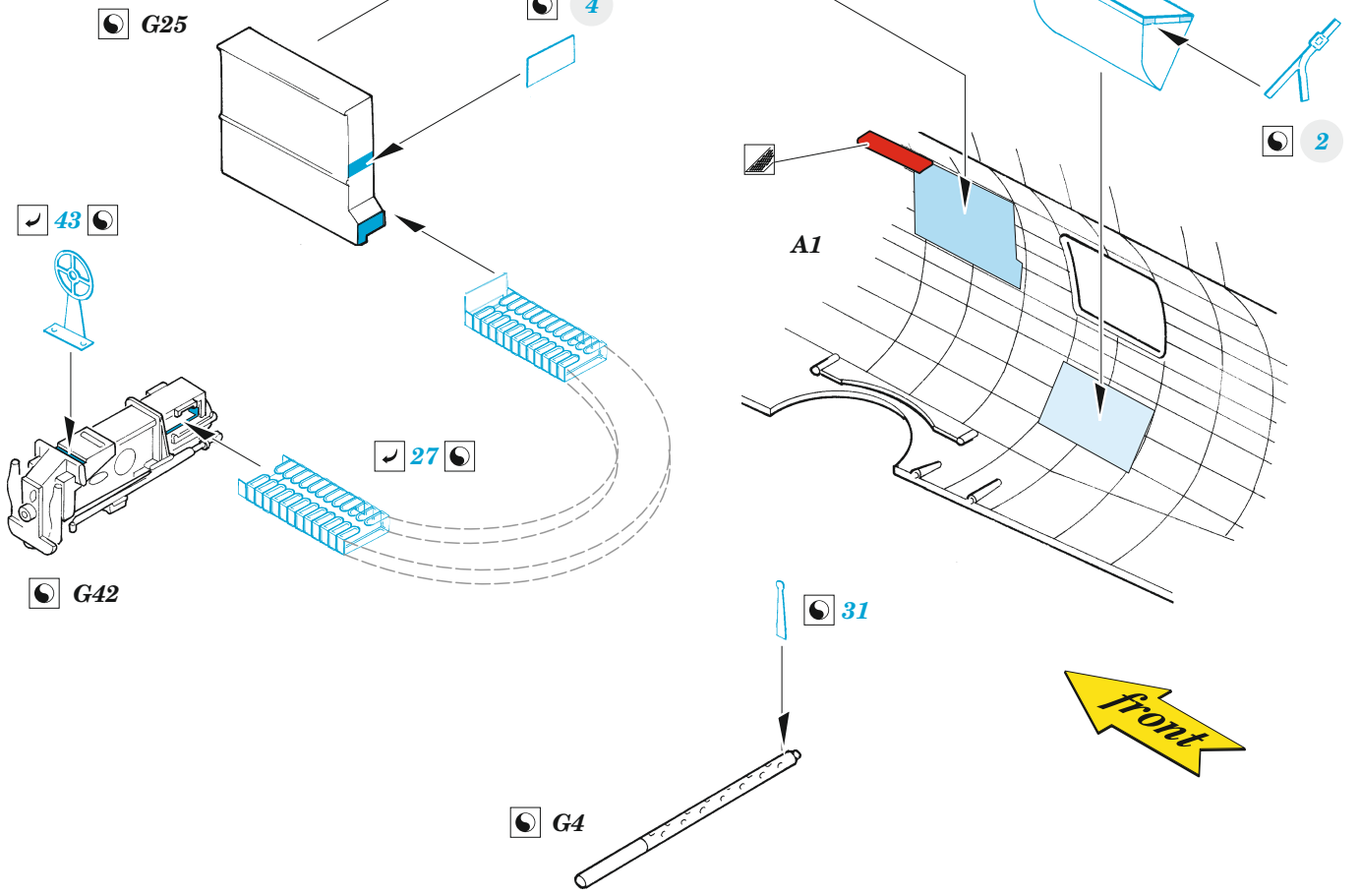

HOW TO MAKE THE RELIEF ON OPPOSITE - REVERSE - OF THE PLATE

ball pen

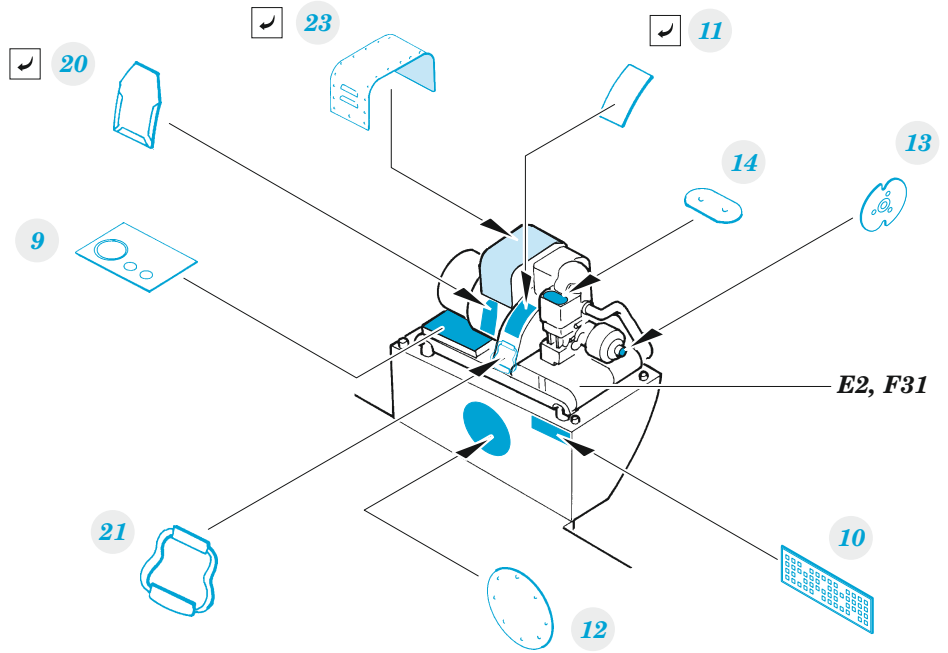
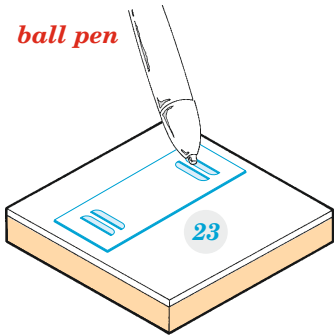

HOW TO MAKE THE RELIEF ON OPPOSITE - REVERSE - OF THE PLATE

ball pen

