

# F-86F-30 Sabre



## EASY ASSEMBLY AUTHENTIC KIT



cyanoacrylate glue  
强力胶



weight  
配重



make hole  
钻孔



cut / remove  
切除



option  
选择



no cement  
不涂胶水



bend  
弯曲



decal  
贴纸

### How to apply the decals

1. Cut off the decal from the decal paper and put it into the warm water 40? for 10 seconds.
2. Take the decal from the water and put it on a piece of clean cloth.
3. Remove the decal slowly from the paper to the targeted location by a wet finger.
4. Use a piece of dry and soft cloth to press it gently on the decal until it getting dry and no bubble existing.

### 水贴纸的使用方法:

- 一、把相关的水贴从水贴纸上剪下,放入40℃左右的温水中浸泡10秒。
- 二、然后将印花放在干净的布上。
- 三、拿上印花纸,手指蘸水将印花移到适当的位置。
- 四、用软干布轻压印花直至水干,气泡消失。

334FS USAF, Pilot Maj. James Jabara. July 1953.

South African Air Force N° 2 Squadron, Korean War.

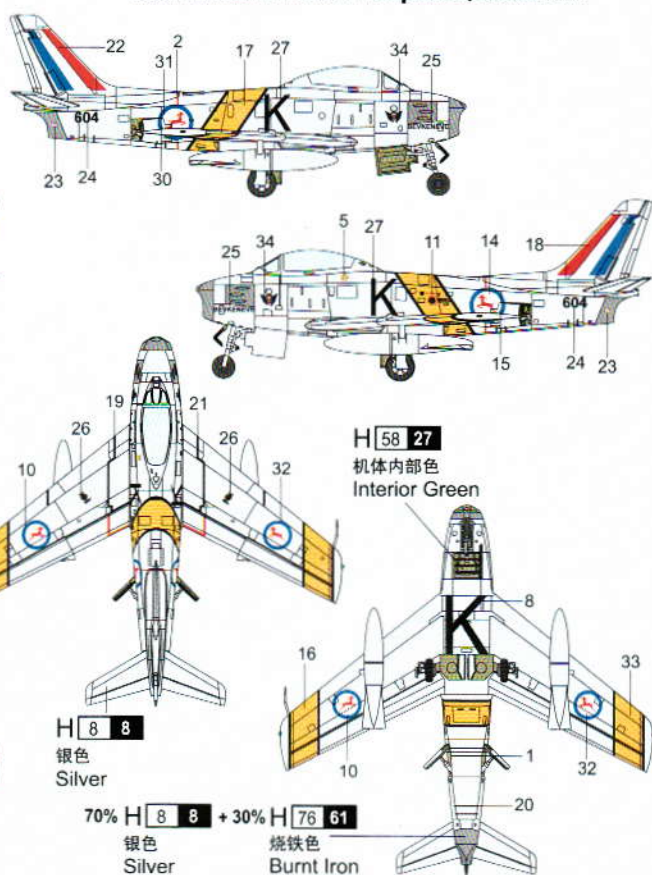
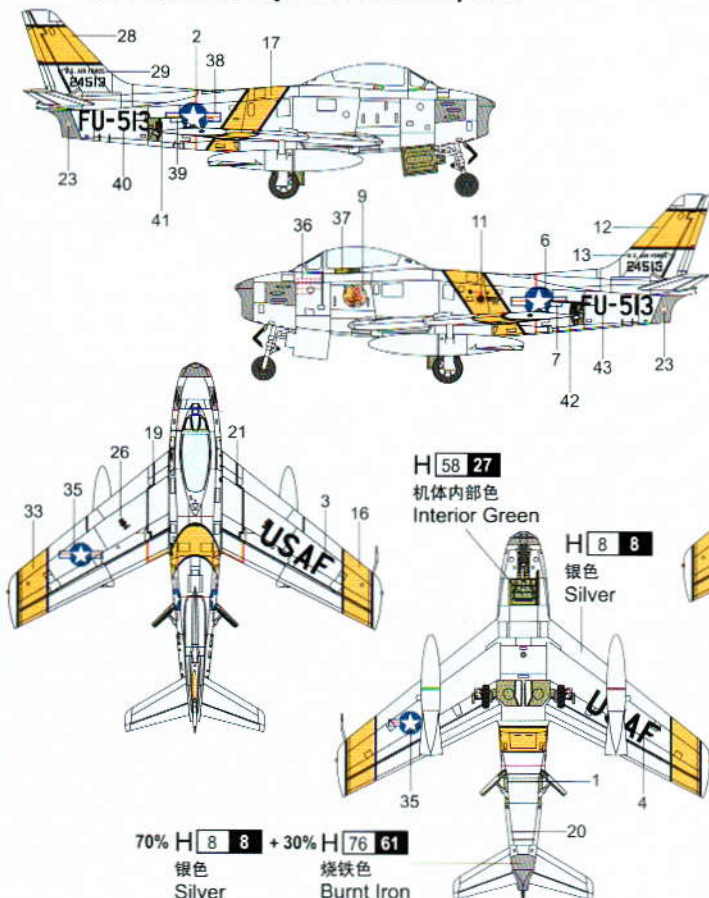

涂装同标贴指示  
Painting & Marking guide

使用Mr.HOBBY涂料  
Mr. Color used

**8** AQUEOUS HOBBY COLOUR **8** MR.COLOUR

\*Some paints may not be available in your country. Please check your local hobby shop for substitute

部品图 Parts

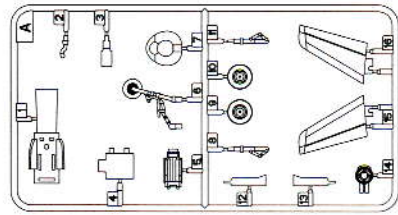

《座舱罩》  
Canopy

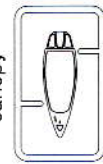

水贴  
Decal

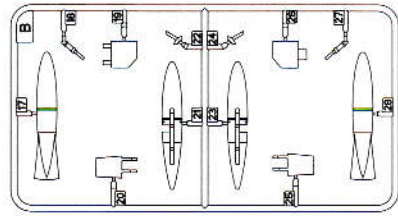

机翼  
Wing

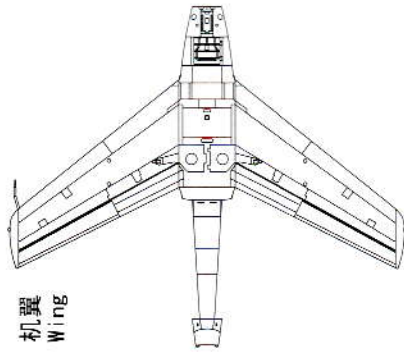

机身  
Fuselage



1

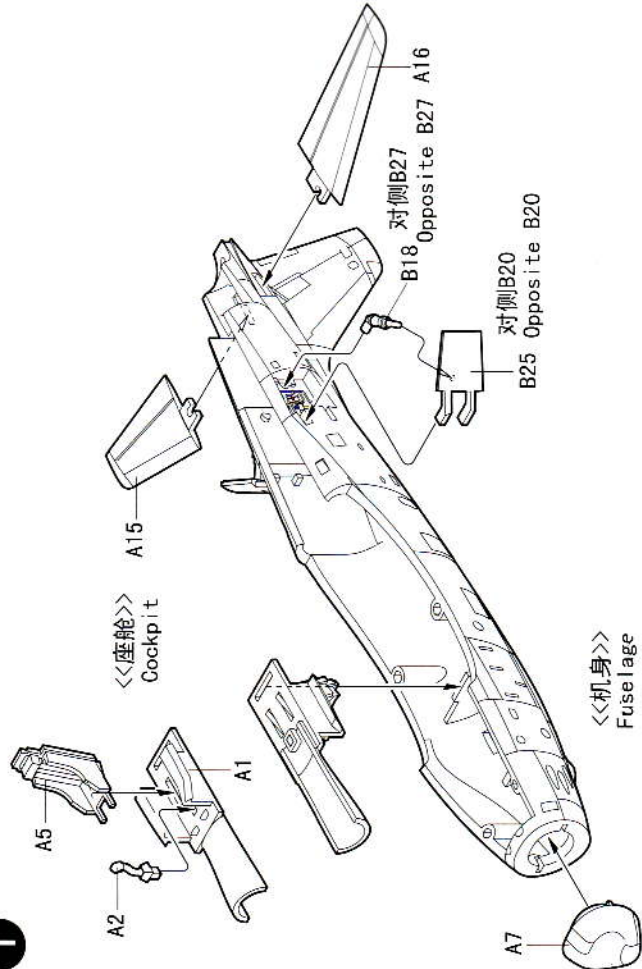

2



《左侧起落架》  
Left undercarriage



《右侧起落架》  
Right undercarriage

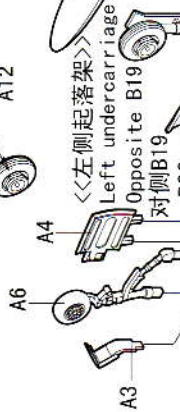

《左侧油箱》  
Left fuel tank

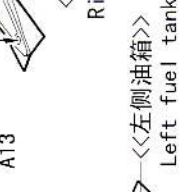

《右侧油箱》  
Right fuel tank

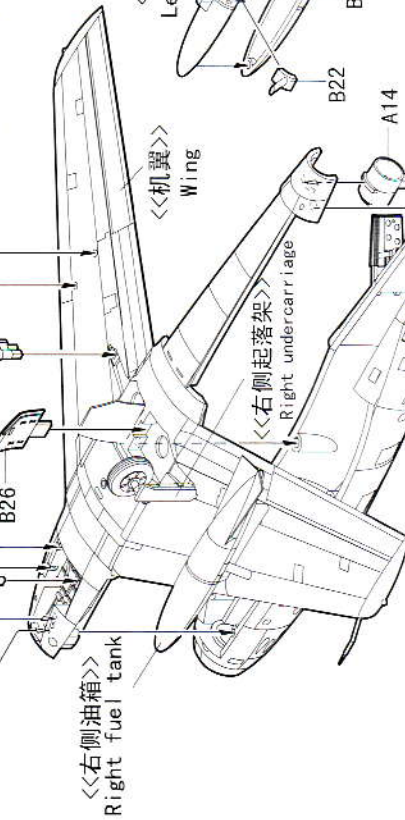

《机翼》  
Wing

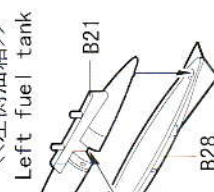

《左侧油箱》  
Left fuel tank



《座舱罩》  
Canopy