

eduard
Express Mask

Spitfire Mk.I

The die-cut mask for accurate canopy frame painting of the
Hasegawa 1/32 KIT

XL 031

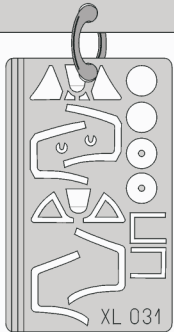

C21

LIQUID MASK

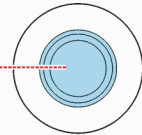
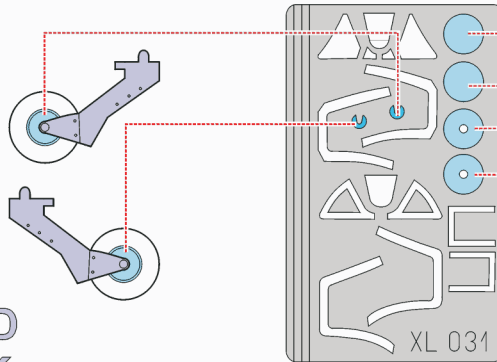

2pcs
C2

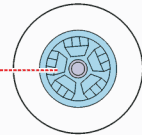

2pcs
C1

1.)

D1

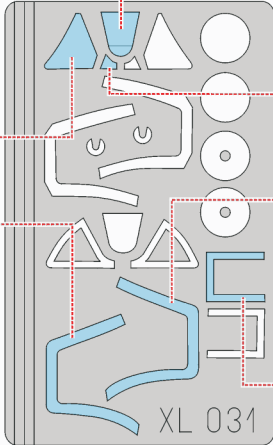
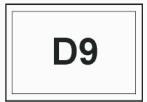
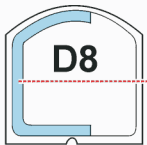
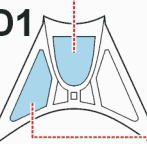

2.)

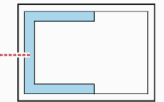
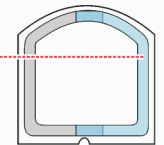
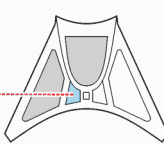

3.)

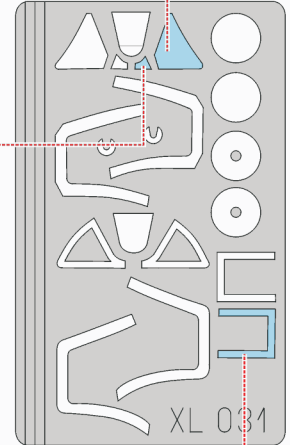
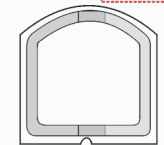
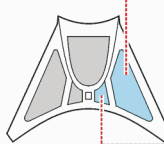

4.)

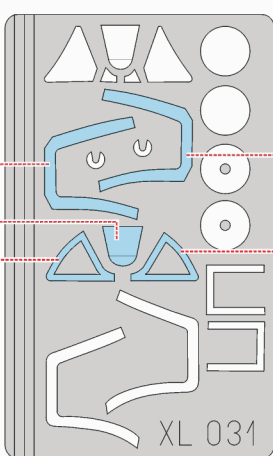
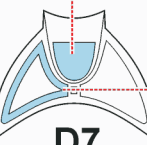
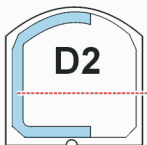

5.)

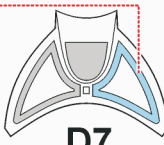

6.)



INTERIOR COLOR

7.)



CAMOUFLAGE COLOR

D9

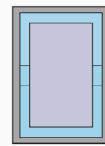

D8

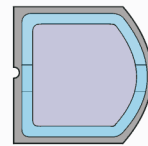

D1

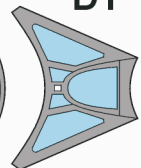

D7

D7

LIQUID MASK



D2

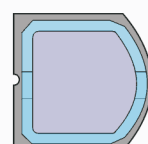

D7

