

#### CUT

USE A SAW TO REMOVE SUPPORTS  
FROM 3D PRINTED PARTS

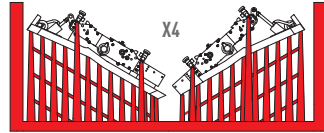

R5

R6

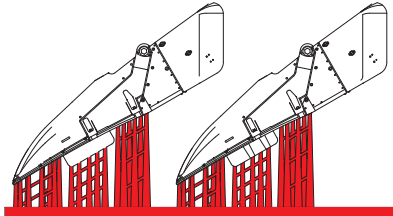

R2

R3

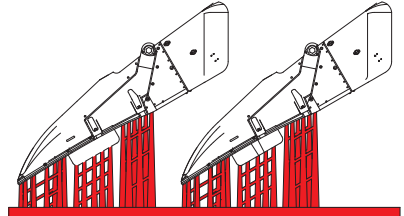

R1

R4

#### 1 RIGHT WING

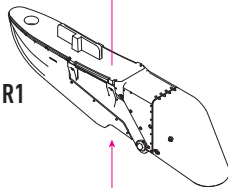
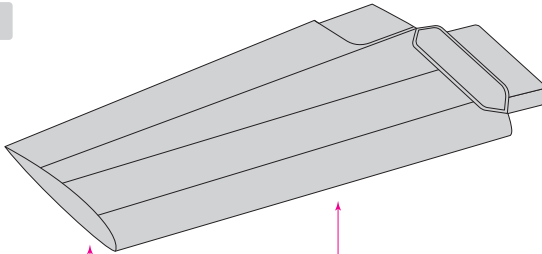

R1

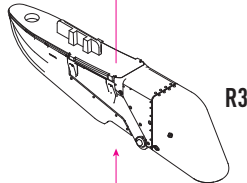

R3

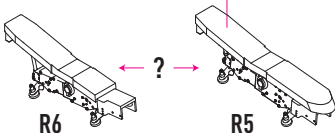

R6

R5

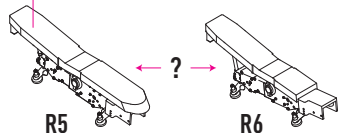

R5

R6

R5 - LOADING WEAPONS, R6 - LOADED IN PARKING POSITION

### 2 LEFT WING

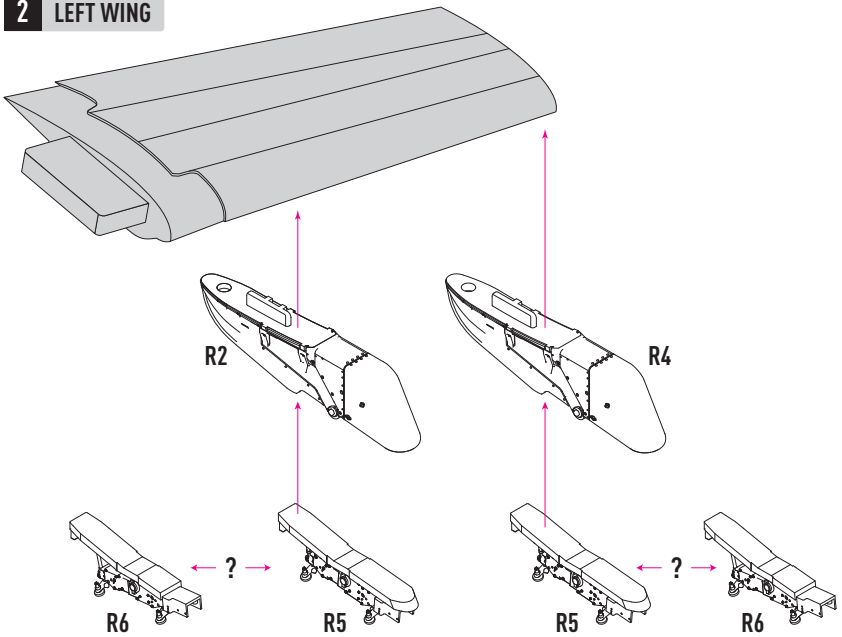

R5 - LOADING WEAPONS, R6 - LOADED IN PARKING POSITION

### LEFT VIEW

