

1/72 SCALE

Zero Fighter Type 52

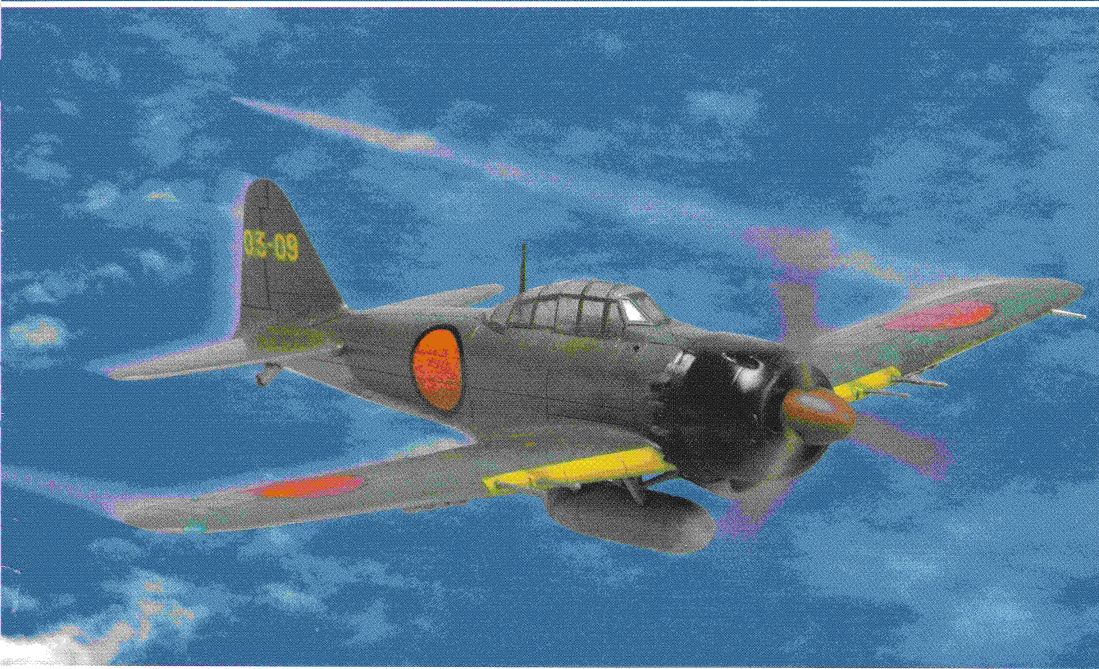

EASY ASSEMBLY AUTHENTIC KIT



cyanoacrylate glue
强力胶



weight
配重



make hole
钻孔



cut / remove
切除



option
选择



no cement
不涂胶水



decal
贴纸



bend
弯曲

The way to apply the decals

1. Cut off the decal from the decal paper and put it into the warm water 40? for 10 seconds.
2. Take the decal from the water and put it on a piece of clean cloth.
3. Remove the decal slowly from the paper to the targeted location by a wet finger.
4. Use a piece of dry and soft cloth to press it gently on the decal until it getting dry and no bubble existing.

水贴纸的使用方法:

- 一. 把相关的印花从水贴纸上剪下, 放入40℃左右的温水中浸10秒。
- 二. 然后将印花放在干净的布上。
- 三. 拿上印花纸板, 手指蘸水将印花移到适当的位置。
- 四. 用软干布轻压印花直至水干, 气泡消失。

80241

部品图

Parts

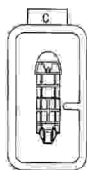
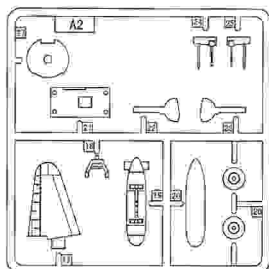
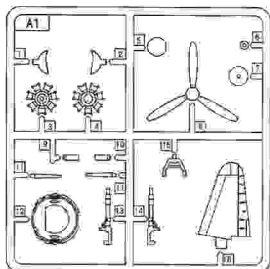

水贴纸
Decal



机身
Fuselage

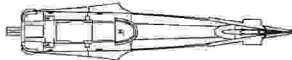

机翼
Wing

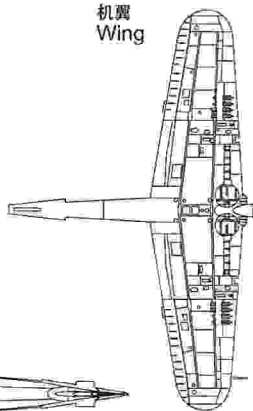

1

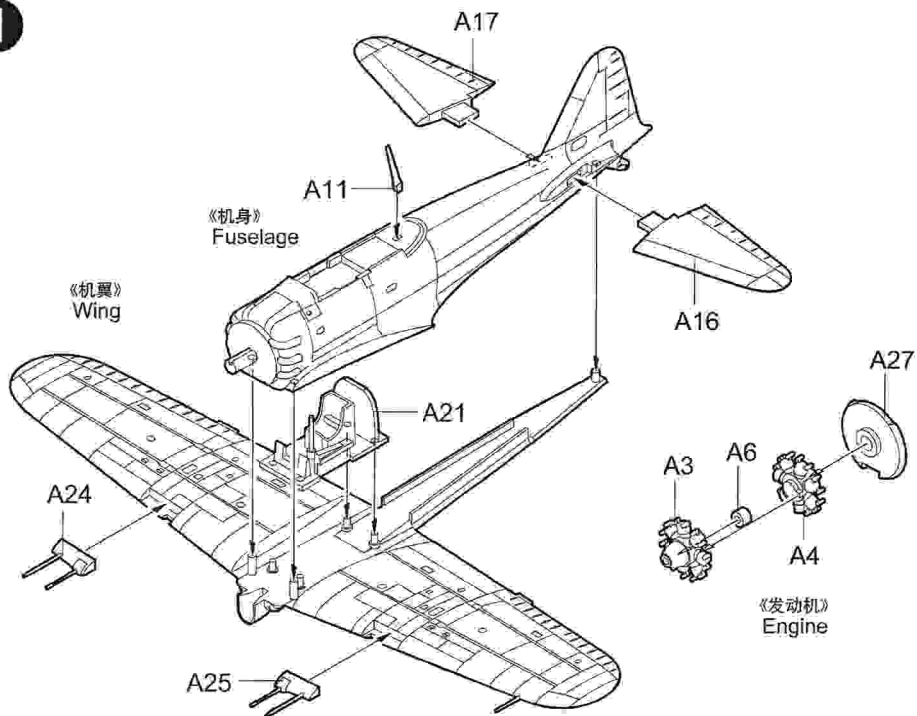

2

《右侧起落架》
Right undercarriage

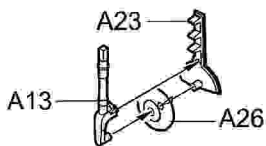

《左侧起落架》
Left undercarriage

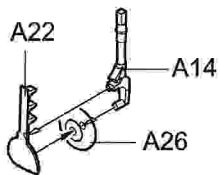

《左侧起落架》
Left undercarriage

《右侧起落架》
Right undercarriage

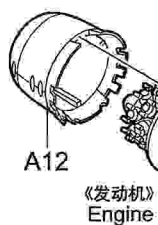

A9 对侧A10
Opposite A10

《油箱》
Fuel tank

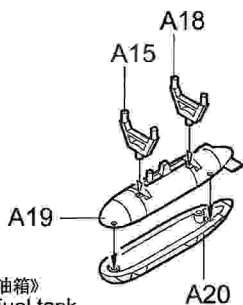

《座舱罩》
Canopy

《螺旋桨》
Propeller

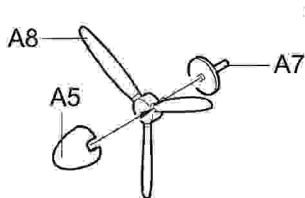

203rd Flying Group W.O.T.TANIMIZU KAGOSHIMA Jun 1945

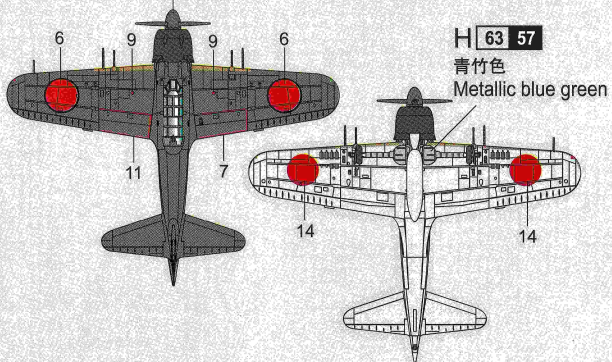
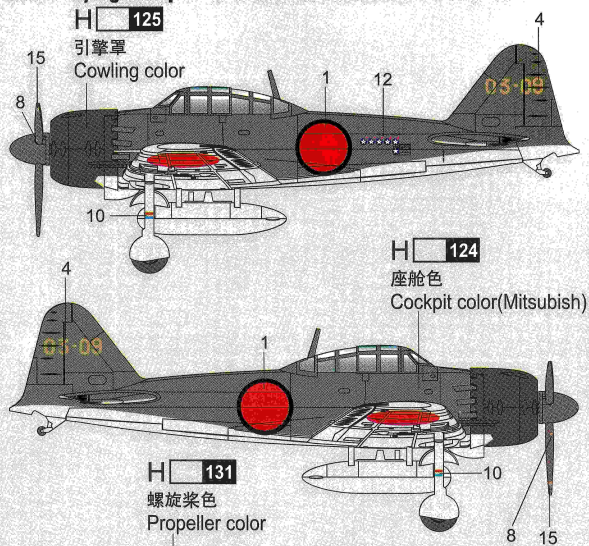

Yokosuka Naval Wing YOKOSUKA 1945 JGSaburo Sakai.

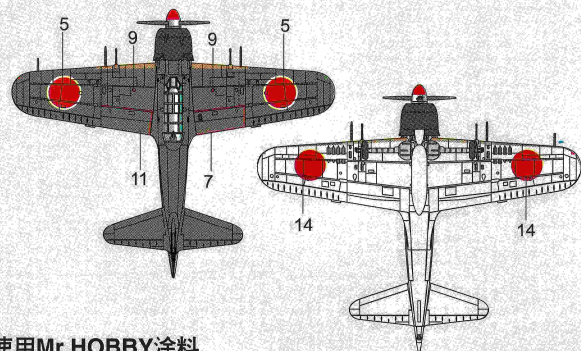
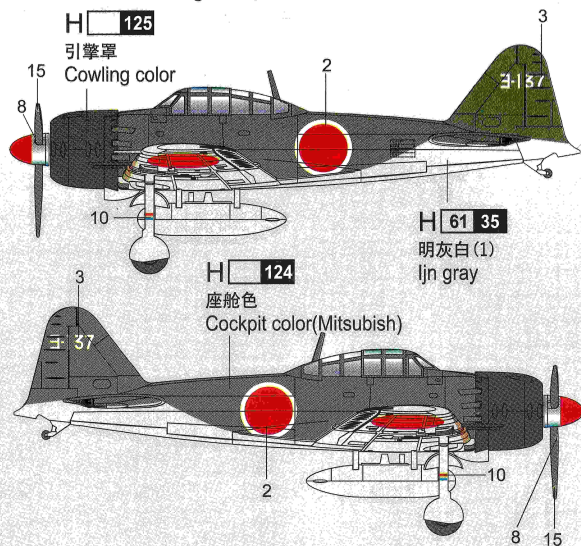

涂装同标贴指示
Painting & Marking guide

使用Mr.HOBBY涂料
Mr. Color used

 AQUEOUS HOBBY COLOUR

 MR.COLOUR

※Some paints may not be available in your country. Please check your local hobby shop for substitute