

1/72 SCALE

He162 "Salamander"



EASY ASSEMBLY AUTHENTIC KIT



cyanoacrylate glue
强力胶



weight
配重



make hole
钻孔



cut / remove
切除



option
选择



no cement
不涂胶水



decal
贴纸



bend
弯曲

水贴纸的使用方法:

- 一. 把相关的印花从水贴纸上剪下, 放入40°C左右的温水中浸10秒。
- 二. 然后将印花放在干净的布上。
- 三. 拿上印花纸, 手指蘸水将印花移到适当的位置。
- 四. 用软干布轻压印花直至水干, 气泡消失。

The way to apply the decals

1. Cut off the decal from the decal paper and put it into the warm water 40°C for 10 seconds.
2. Take the decal from the water and put it on a piece of clean cloth.
3. Remove the decal slowly from the paper to the targeted location by a wet finger.
4. Use a piece of dry and soft cloth to press it gently on the decal until it getting dry and no bubble existing.

1./061 May 1945.

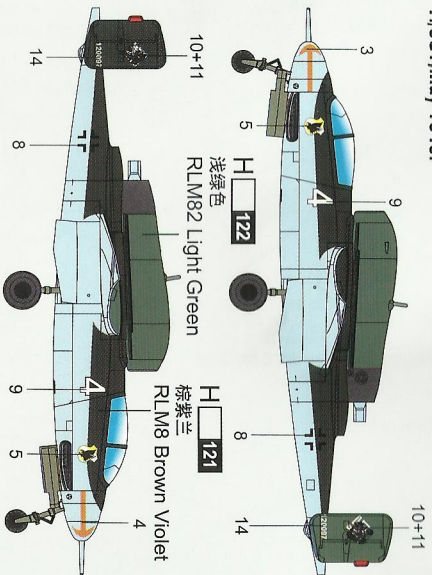

Soviet, USSR 1946.

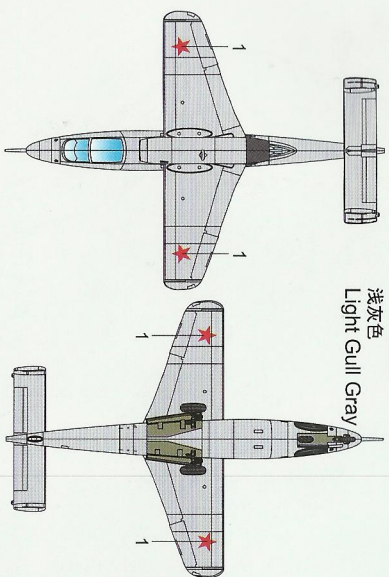
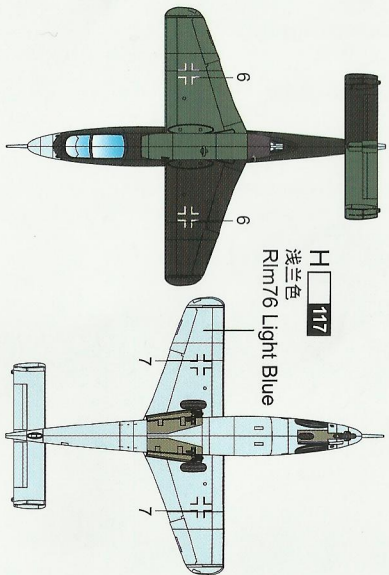
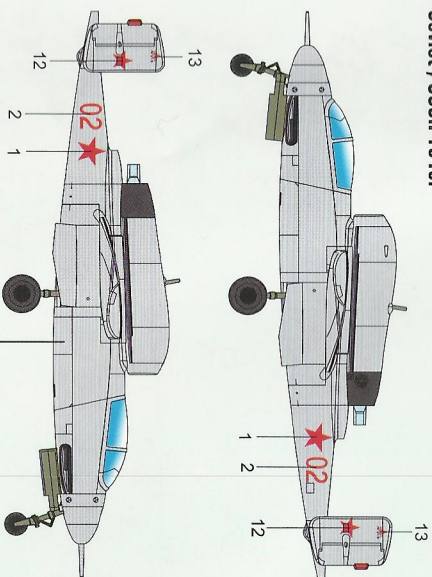

使用MR.HOBBY涂料
Mr. Color used

8 AQUEOUS HOBBY COLOUR

8 MR. COLOUR

*Some paints may not be available in your country. Please check your local hobby shop for substitute

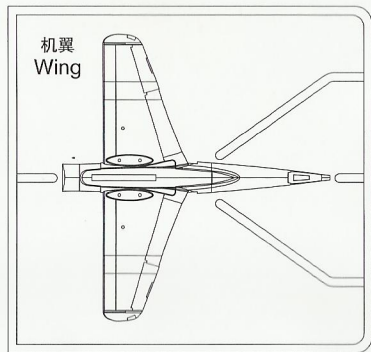
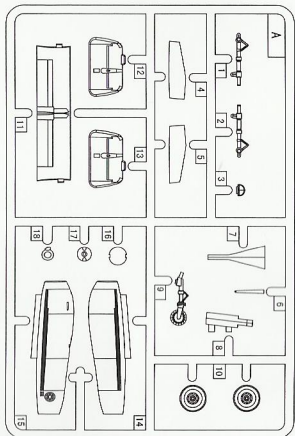

水贴
Decal



机身
Fuselage

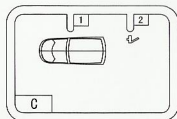
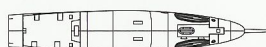

部品图 Parts

1

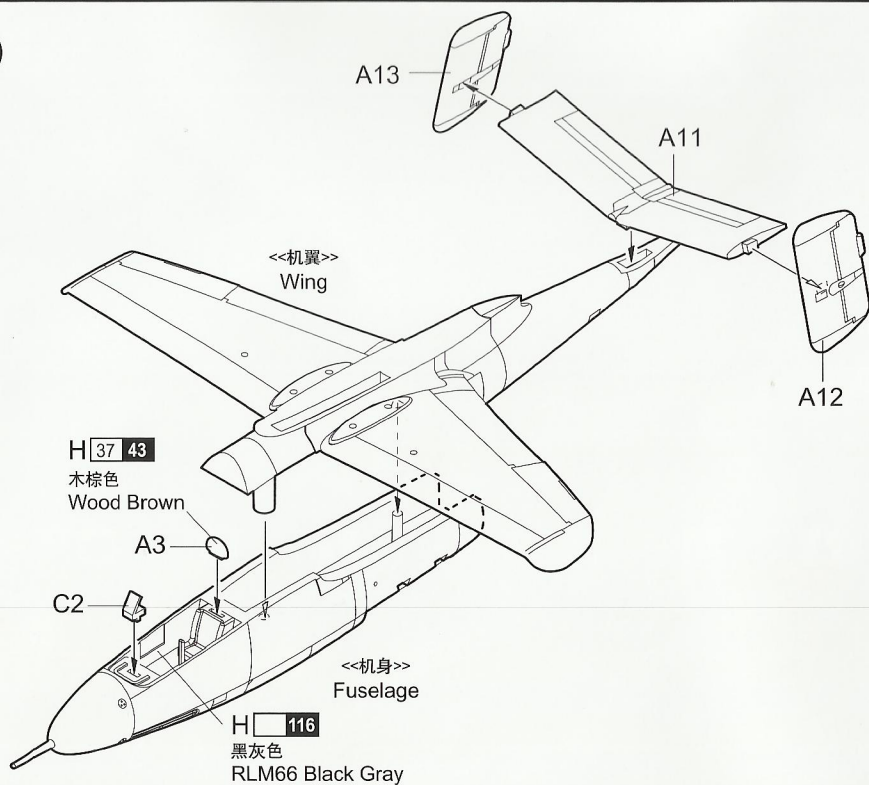

2

