

SOVIET SPAAG

ZSU-57-2

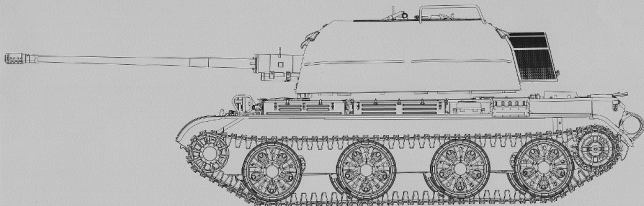

The ubiquitous T-54 & T-55 series is the most produced tank type in history, with an estimated 160,000 units having been produced in Russia, Czechoslovakia, Poland, and China. These tanks have been evolving since their inception at the end of WWII, continuously incorporating improved weapons, powerplants, and protection, and they continue to be rebuilt and refurbished with local upgrades even today. They have also formed the basis of many other AFVs, such as ARV's, APC's and AVLB's, and still serve in large numbers today with as many as 50 nations.

First seen by the public: In 1957, the ZSU-57-2 was the first Soviet self-propelled anti-aircraft gun to be mass produced, and was the only Soviet SPAAG based on the T-54. The welded steel hull uses thinner armor than the standard T-54, and its weight is further reduced by removing one road wheel station on each side while still retaining the standard footprint. The driver has his own hatch on the glacis reminiscent of the T-34. The remaining 5 crewmen are exposed in the large hydraulically powered turret, which houses a pair of 57mm S-68 guns with 316 rounds ready. These guns are unbalanced and guided with an optical fire-normal system, and can elevate from -5° to +85°. The guns fire the same ammunition as the S-60 towed AA gun at a muzzle velocity of 1000m per second, including 2 types of FRAG anti-aircraft projectiles (which can reach a maximum ceiling of 8000m) and 2 types of APC anti-armor projectiles (which have an effective horizontal range of 12,000m and can pierce 98mm armor plate at a range of 1000m). These guns each have practical and cyclic firing rates of 70 and 120 rounds per minute, respectively. The 2 loaders load the guns in clips of 4 at the front of the turret, the commander is stationed at the rear on the right, the gunner is at rear on the left, and the fuse setter is to the right of the gunner. Because it lacks any modern fire control systems to combat modern battlefield threats from the air, the ZSU-57-2 has been replaced in all front-line units. Nevertheless, the ZSU-57-2 continues to serve under the flags of many nations today.

READ BEFORE ASSEMBLY

CAUTION

- Read carefully and fully understand the instructions before commencing assembly. A supervising adult should also read the instructions if a child assembles the model.
- When assembling this kit, tools including knives used. Extra care should be taken to avoid personal injury.
- Keep out of reach of small children. Children must not be allowed to suck any part, or pull vinyl bag over their heads.



Optional



Do Not Cement



Remove



Drill



Instant Glue
for Metal

PAINTS REQUIRED

Color info and profiles by Mig Jimenez

3.000.021	Reddish Tan	3.000.044	Dark Olive	3.000.020	Dark Red	3.000.040	Gun Metal
3.000.028	Dark Green Tan	3.000.029	Dark Green	3.000.041	Dark Blue	3.000.030	Light Green (#1)
3.000.022	Dark Green (#2)	3.000.026	Medium Green	3.000.024	Light White	3.000.038	Forest Green
3.000.027	Protective Coat	3.000.025	Light Yellow	3.000.023	Grey Blue	3.000.036	Lightening Yellow
3.000.023	Dark Green						

APPLYING DECALS

1. Clean the model surface with a wet cloth.
2. Cut out each decal design from sheet, and dip it in tepid water for 15-20 sec.
3. Hold the backing sheet edge and slide decal onto the model.
4. Move decal into position by wetting decal with finger.
5. Press decal gently down with a soft cloth until excess water and air bubbles are gone.

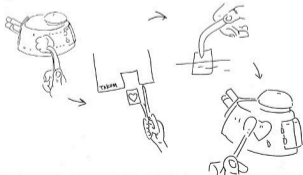

REMOVING PE



Be careful not to hurt when removing PE parts.

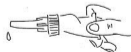

Secure using instant glue (not included).



Finish using file.

PARTS

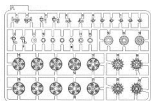

X2



X4

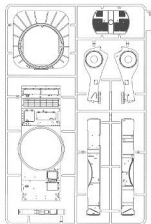
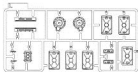

X2



X5



Decal



Turret

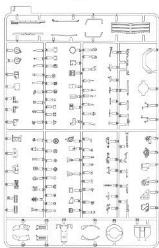

— Cable

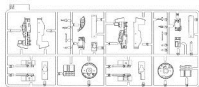

TP

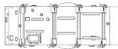

Lower Hull



X184



Dust Cover

1

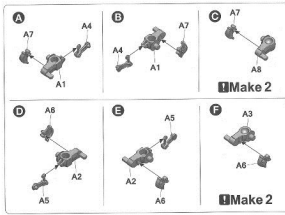
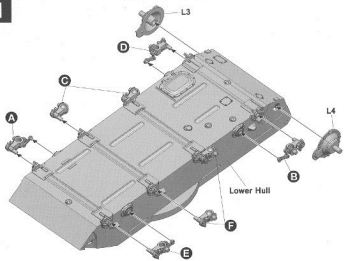

Make 2

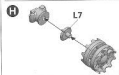
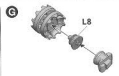

Make 2

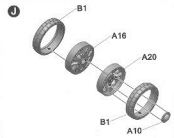

Make 8

2

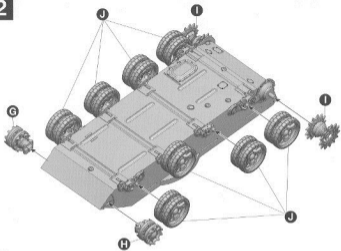

3

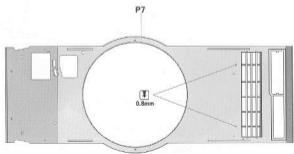

4

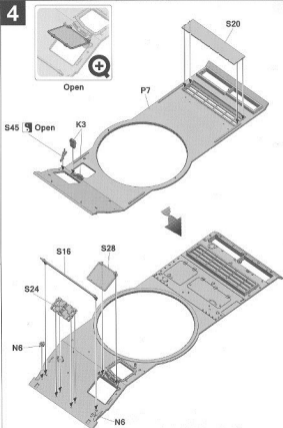

5

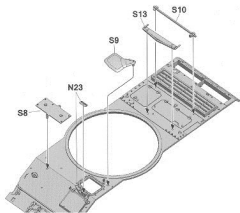

6

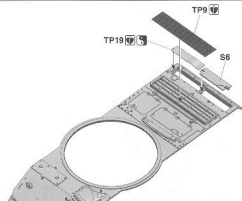

7

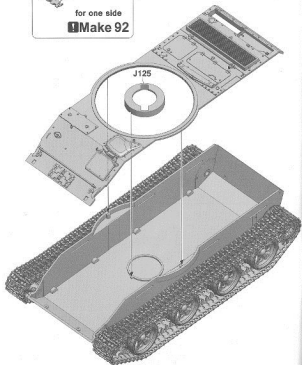

8-2 NVA Germany

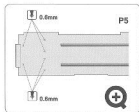

8

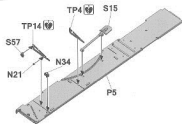

9-1 Soviet

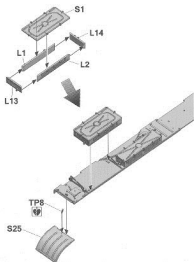
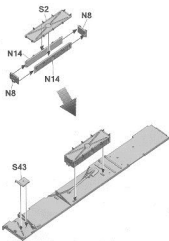
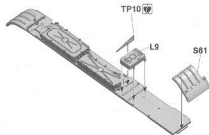

9-2

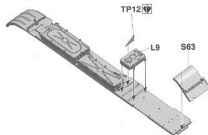

10-1

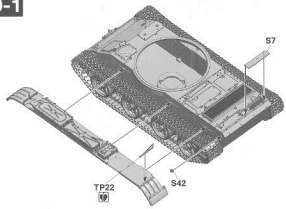

10-2

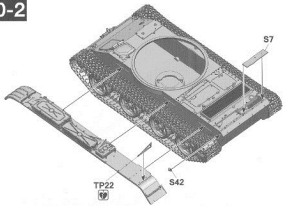

11-1

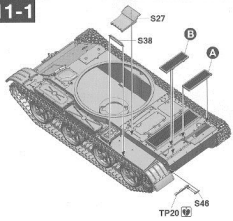

(A)

TP13
S23

(B)

TP13
S22

11-2

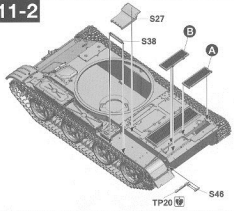

(A)

TP13
S23

(B)

TP13
S22

12-1

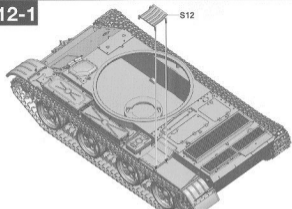

13-1

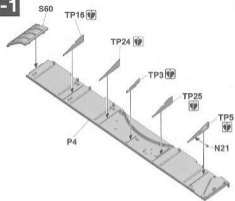

12-2

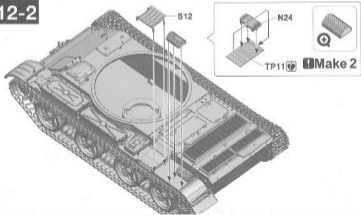

13-2

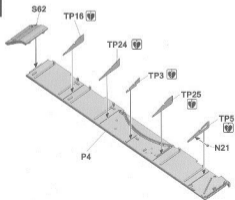

14-1

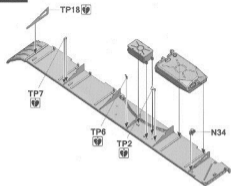

N33 X2

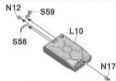

N17



15-1

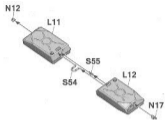

14-2

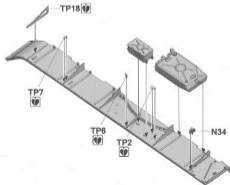

N33 X2

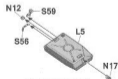

N17



15-2

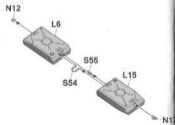

16-1

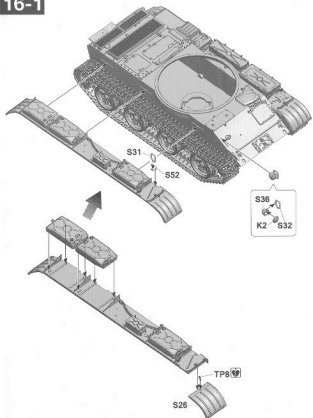

16-2

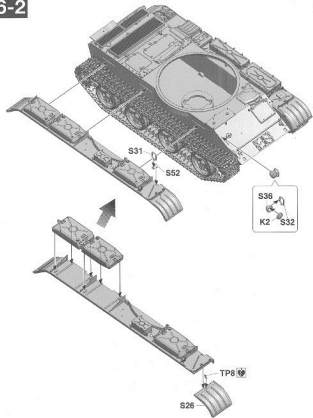

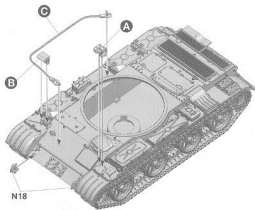
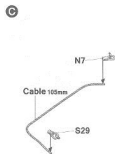
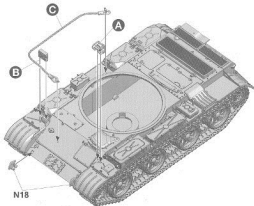
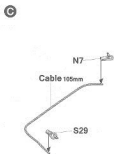

18-1

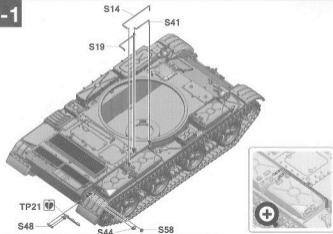

19-1

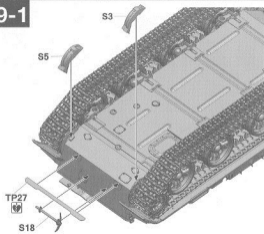

18-2

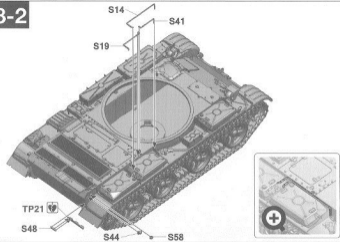

19-2

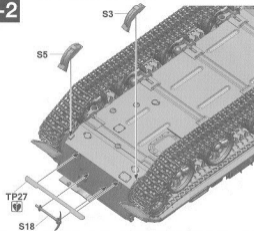

20-1

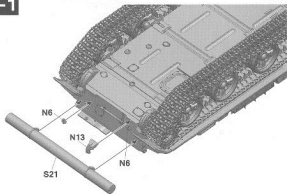

21-1

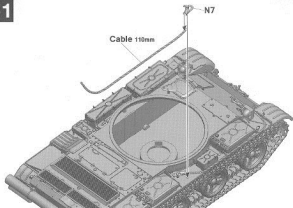

20-2

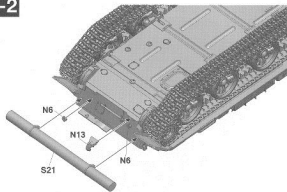

21-2

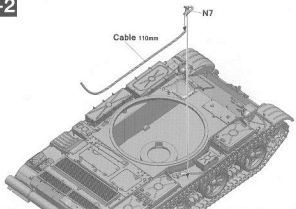

22-1

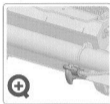
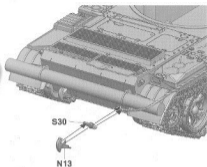

23

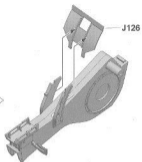
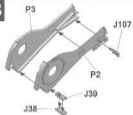

22-2

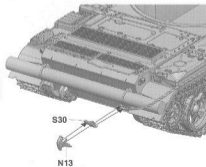

24

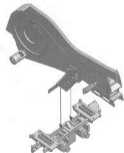
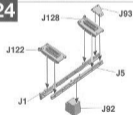

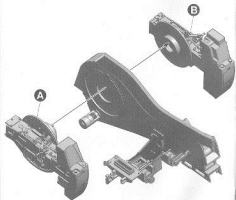
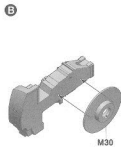
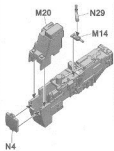
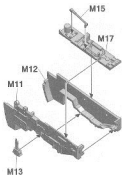
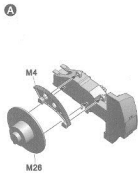
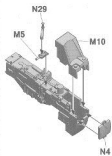
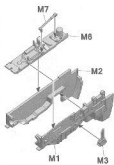

26

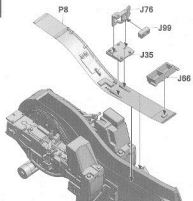

28

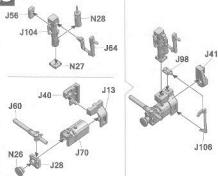

27

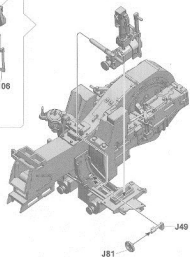
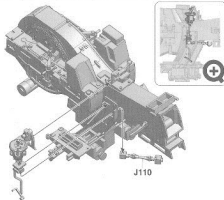

29

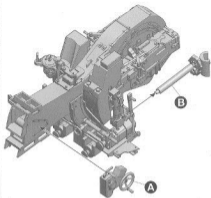

30

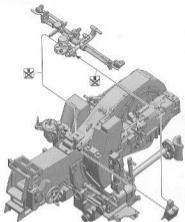

31

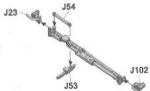
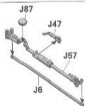
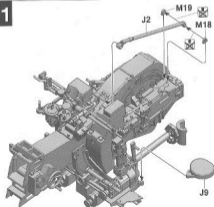

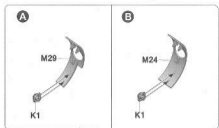

H Push in with heated screw driver etc.

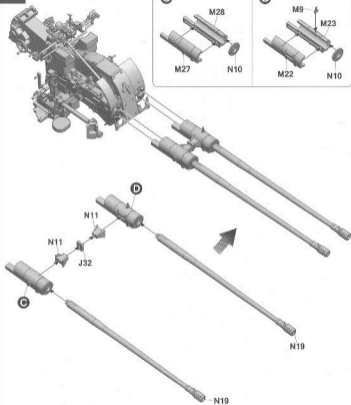
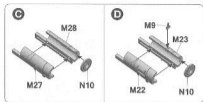
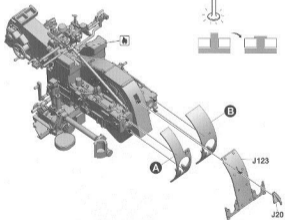

34

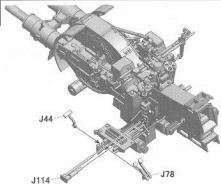

36

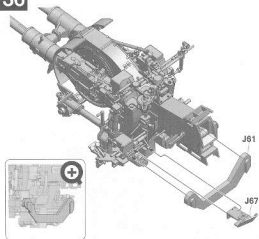

35

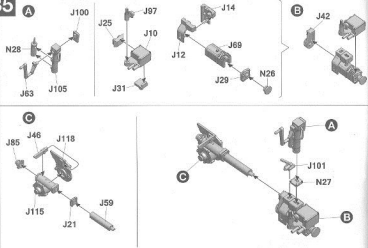

37

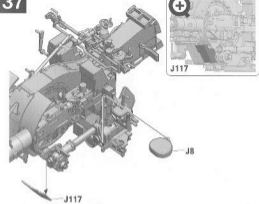

38

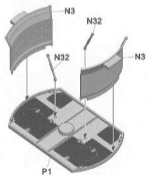

39

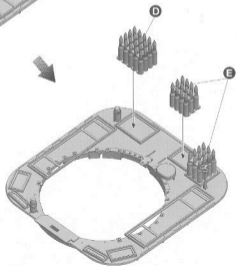
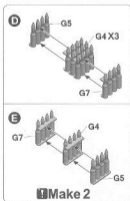
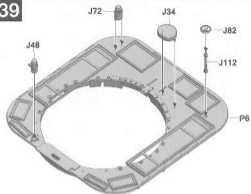

40

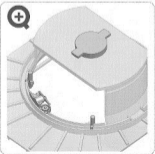
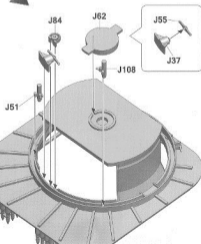
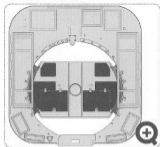
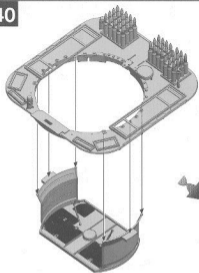

41

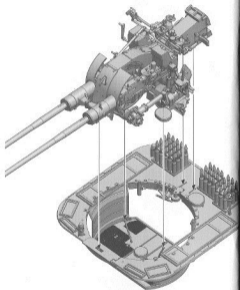

42

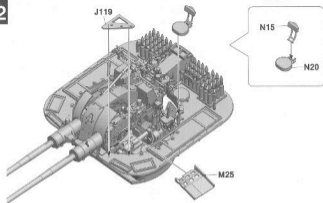

44

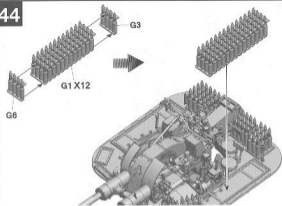

43

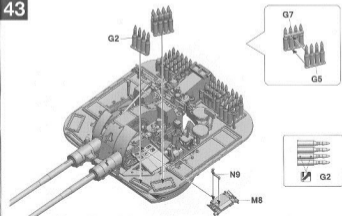

45

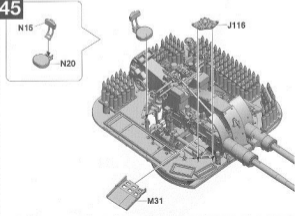

46

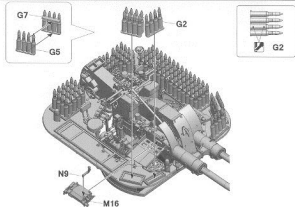

48

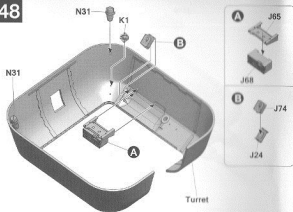

47

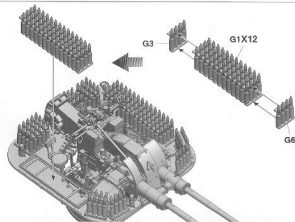

49

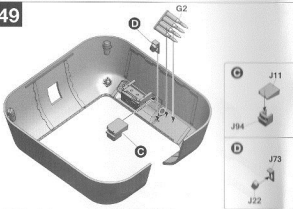

50

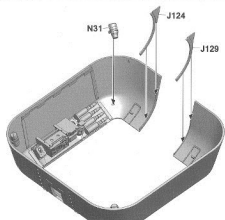

51

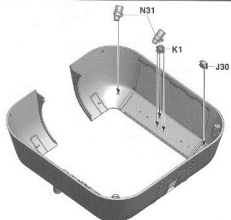

52

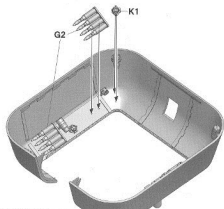

53

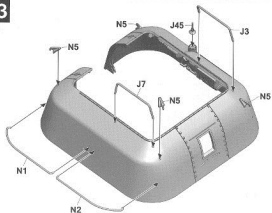

54



55



56

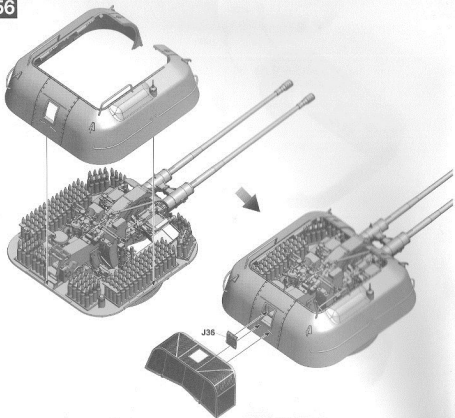

57-1

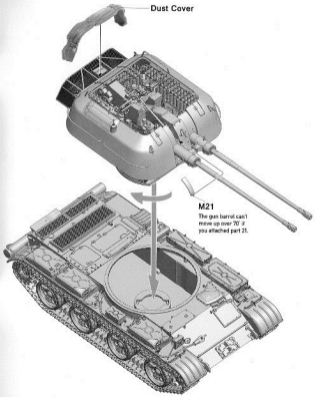

57-2

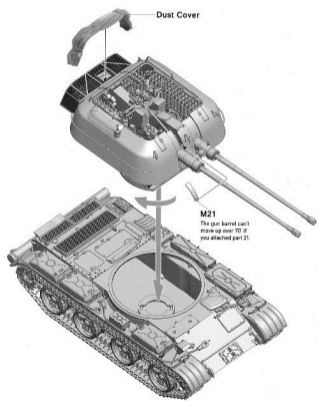

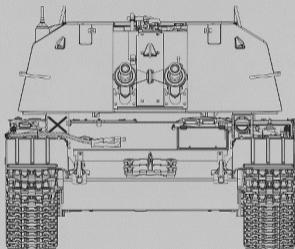

You can find TAKOM on Facebook.com



03.03.2058

TAKOM

SPAAG ZSU-57-2

Color info and profiles by



Painting and Marking Guide

A.MIG 033 Hull & Turret

A.MIG 034 Rail Tracks

A.MIG 036 Old Wheel

A.MIG 045 Gun Mount

A.MIG 015 Rail Travers Base

A.MIG 035 Turret Stand

A.MIG 046 Hot Block

Figyólató Állás
Az Új Széchenyi

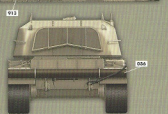
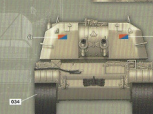
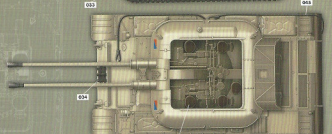
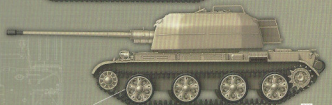
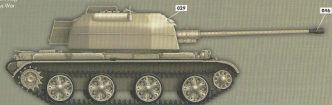

TAKOM

Soviet SPAAG ZSU-57-2, late Type (2 IN 1), Ref. 2058

SPAAG ZSU-57-2

Color info and profiles by



Painting and Marking Guide

AMO 033

AMO 034

AMO 036

AMO 040

AMO 913

AMO 065

NVA Germany

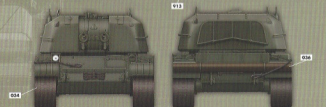
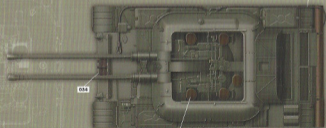

034

TAKOM

Soviet SPAAG ZSU-57-2 Late Type [2 IN 1], Ref. 2058

SPAAG ZSU-57-2

Color info and profiles by



Painting and Marking Guide

AMO 033

AMO 034

AMO 036

AMO 040

AMO 913

AMO 047

AMO 083

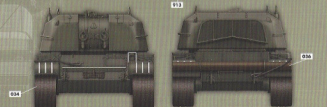
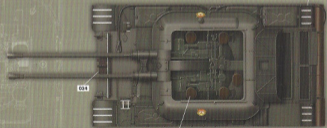
Soviet Army
Mikoyan Protok. 1940

034

TAKOM

Soviet SPAAG ZSU-57-2 Late Type [2 IN 1], Ref. 2058

Painting and Marking Guide

AMG 033 Rubber & Tire
 AMG 034 Rail Tracks
 AMG 035 Oil/Wood
 AMG 043 Gun Metal

AMG 913 Red Brown Iron
 AMG 020 Protective Coating
 AMG 044 Matt Black

Soviet Army
 Sukhoi War 1991

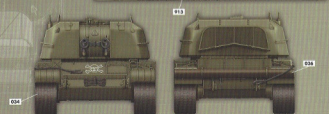
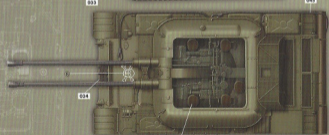

Painting and Marking Guide

AMG 033 Rubber & Tire
 AMG 034 Rail Tracks
 AMG 035 Oil/Wood
 AMG 043 Gun Metal

AMG 913 Red Brown Iron
 AMG 030 Sand Yellow
 AMG 911 Gray Stone
 AMG 915 Dark Green

Syrian Army
 Yasa Kappan 1973

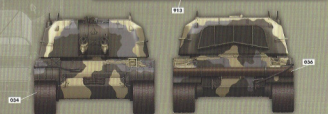
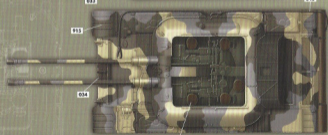

You can find some of these paints in this AMMO colour set!



Painting and Marking Guide

ARM 030 Olive & Teal ARM 034 Iron Oxide ARM 036 Old Wood ARM 040 Gun Metal

ARM 913 Red Brown Base ARM 983 Darkkhaki Yellow

North Vietnamese Army,
Vietnam War

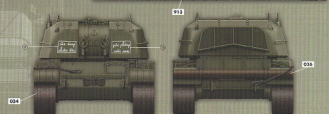
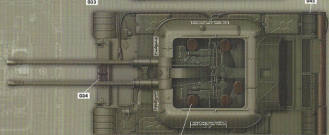

Painting and Marking Guide

ARM 030 Olive & Teal ARM 034 Iron Oxide ARM 036 Old Wood ARM 040 Gun Metal

ARM 913 Red Brown Base ARM 983 Darkkhaki Yellow

North Vietnamese Army,
Vietnam War

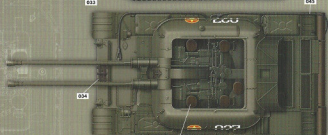

Painting and Marking Guide

AMO 033 Rubber & Tire	AMO 034 Fuel Tanks	AMO 036 Chassis	AMO 040 Gun Mount
AMO 913 Red Brown Base	AMO 035 Desert Sand		

Iran Army

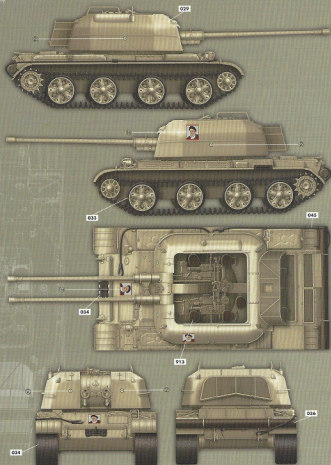

Painting and Marking Guide

AMO 033 Rubber & Tire	AMO 034 Fuel Tanks	AMO 036 Chassis	AMO 040 Gun Mount
AMO 913 Red Brown Base	AMO 035 Desert Sand	AMO 046 Mott Muck	

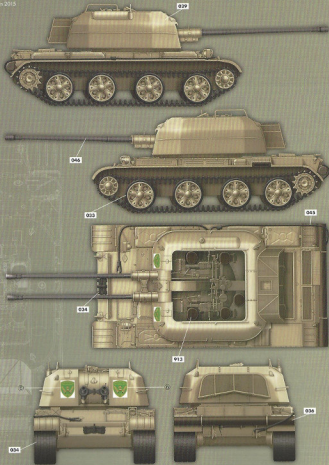
North Iraq,
Kurdsan 2015

SPAAG ZSU-57-2

Color info and profiles by



Painting and Marking Guide

AMS 033 Rubber & Tire AMS 034 Rear Tracks AMS 036 Old Wood AMS 045 Gun Metal

AMS 913 Red Brown Base AMS 046 Black AN44 AMS 040 Light Green AN22 AMS 043 Dark Green AN25

Finchh Army

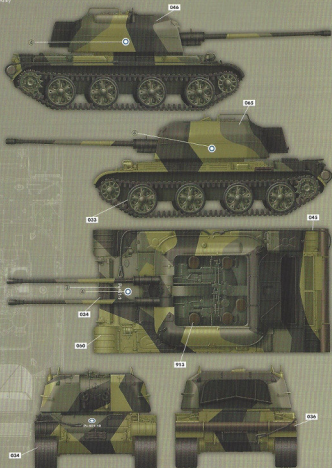

SPAAG ZSU-57-2

Color info and profiles by



Painting and Marking Guide

AMS 033 Rubber & Tire AMS 034 Rear Tracks AMS 035 Old Wood AMS 043 Gun Metal

AMS 910 Red Brown Base AMS 037 Desert Sand AMS 030 Modern Brown

Finch Army
Iron, Iron, Yellow

