

eduard
Express Mask

XS 091

Mirage 2000 C/D

The die-cut mask for accurate canopy frame painting of the
Italeri 1/72 KIT

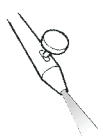
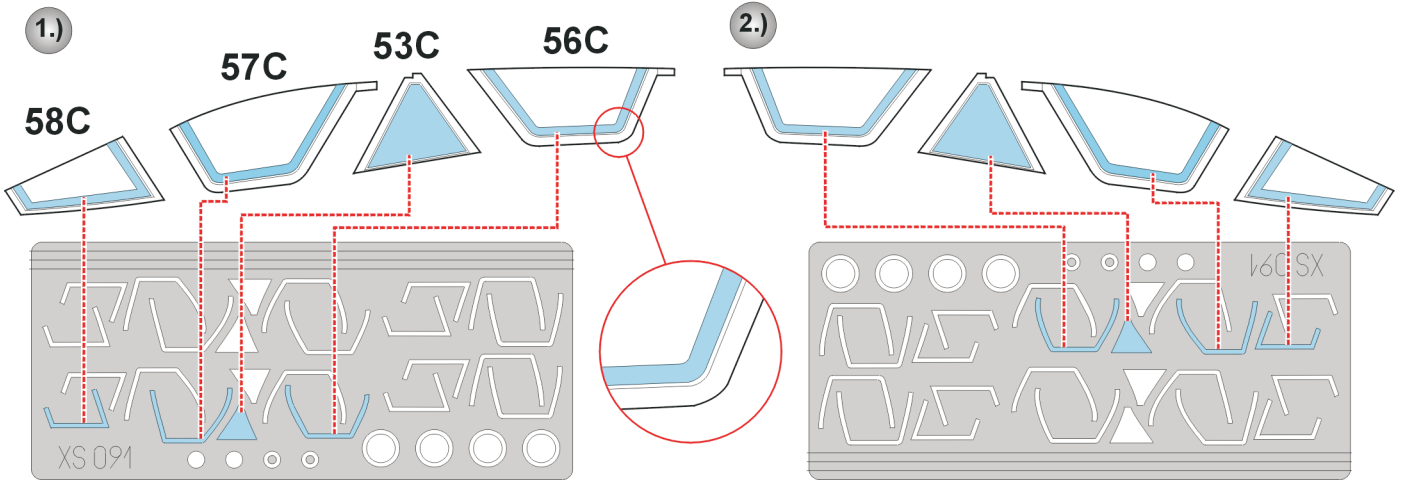
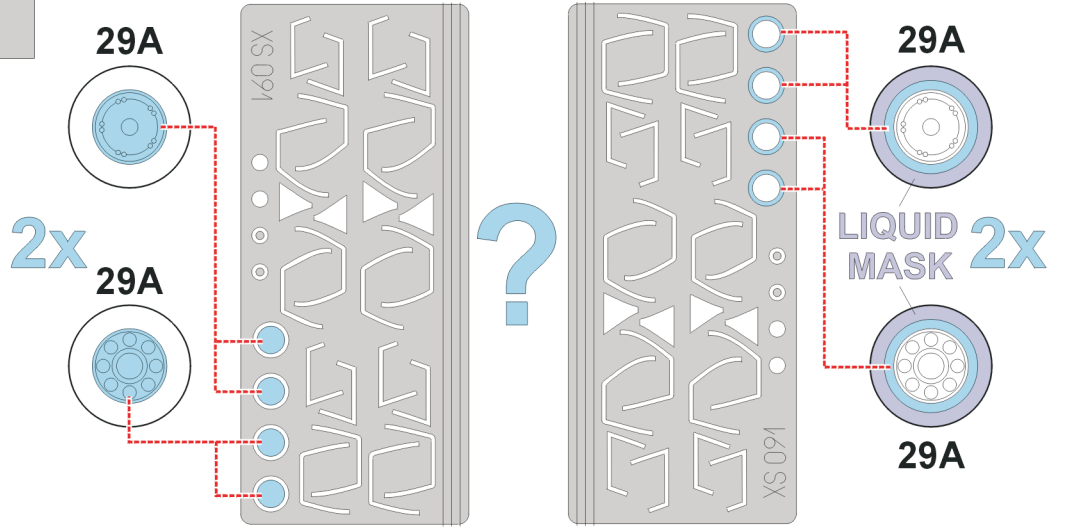
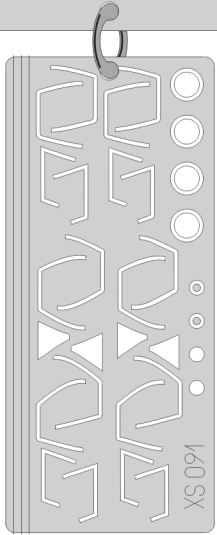

3.)
INTERIOR COLOR

LIQUID MASK

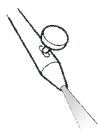
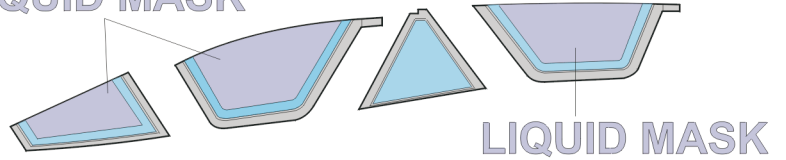

4.)
RUBBER COLOR

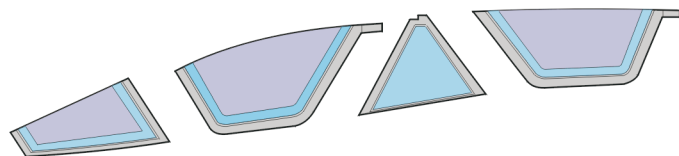

5.)
REMOVE MASK



6.)

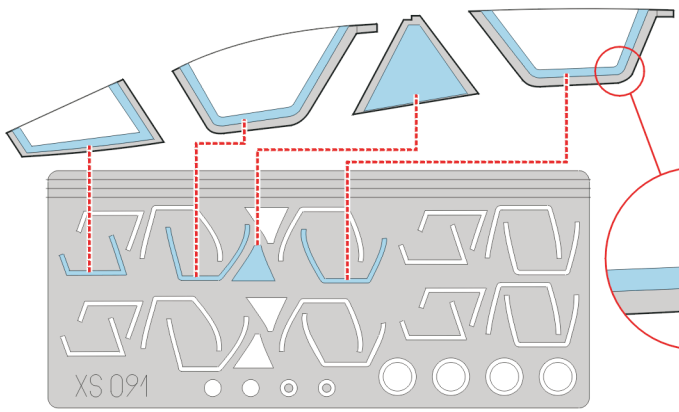

7.)

CAMOUFLAGE COLOR
LIQUID MASK

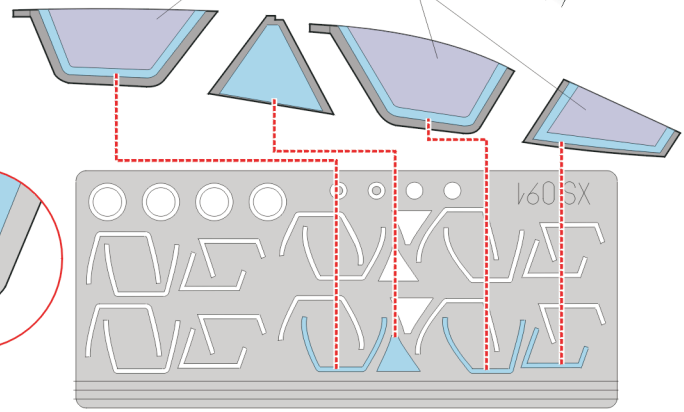

1.)

57C

58C

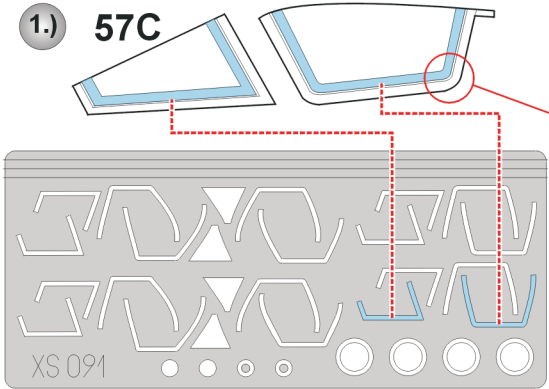

2.)

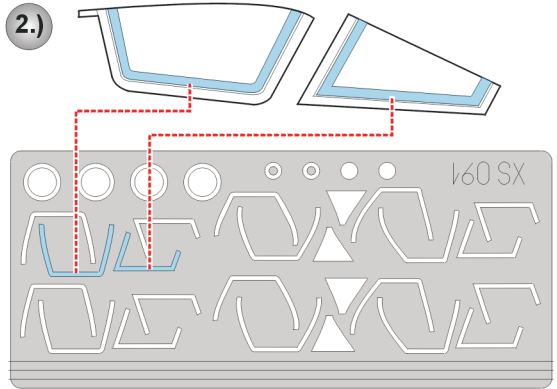

3.)

INTERIOR COLOR

LIQUID MASK

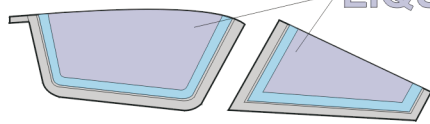

4.)

RUBBER COLOR

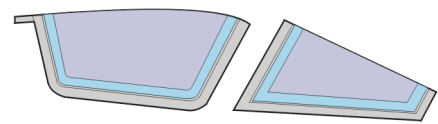

5.)

REMOVE MASK



6.)

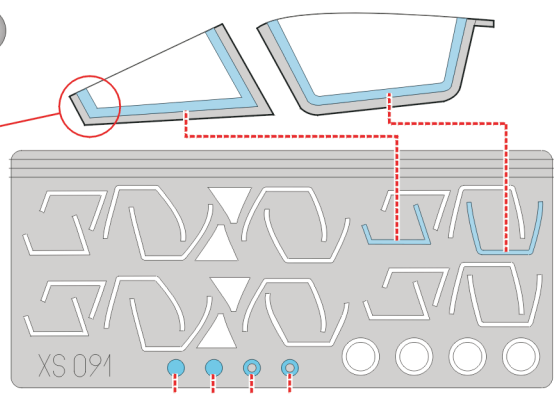
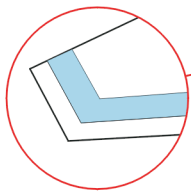

7.)

CAMOUFLAGE COLOR

LIQUID MASK

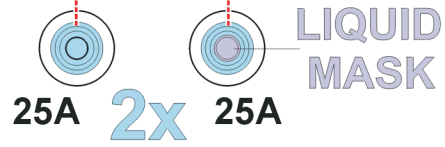
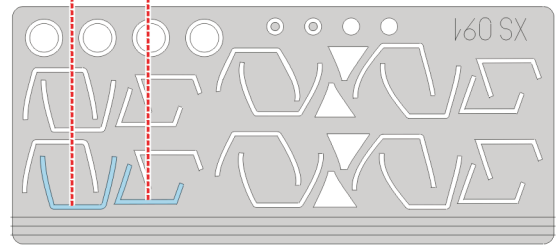
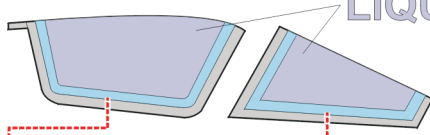

REFERENCES: KOKU-FAN #3 March 1999
 Aeroporia&Naytiko - Mirage 2000
 Przegląd konstrukcji lotniczych #10 - 6/1999
 HPM #1/1999
 HPM #2/1999
 HPM #3/1999
 LK #16/1996
 ATM #3/1995