

eduard
MASK

EX 184

F-15A/C Eagle 1/48

The die-cut mask for accurate canopy frame painting of the
Hasegawa scale 1/48 KIT

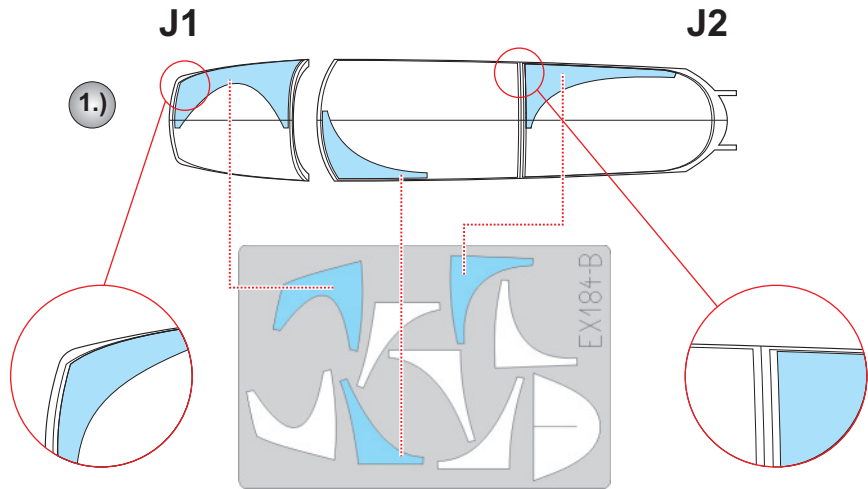
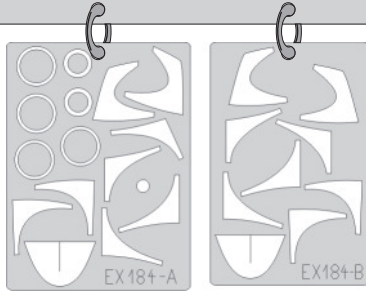

REFERENCES:

MODEL ART #576 january 2001
OSPREY COMBAT AIRCRAFT #27

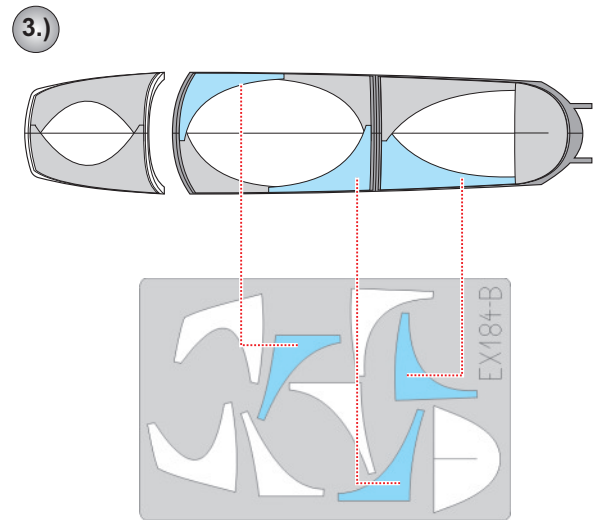
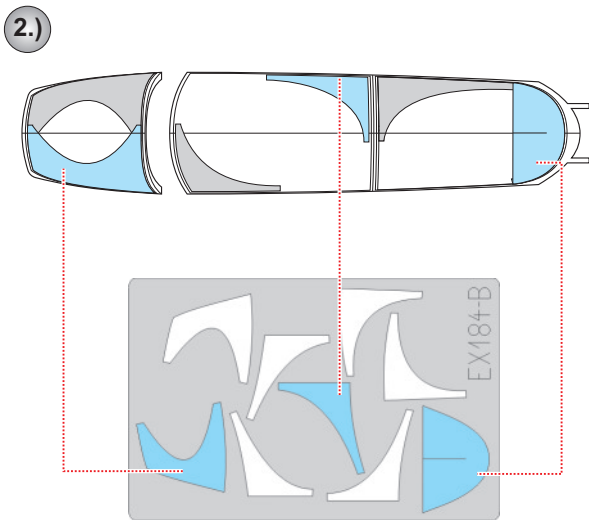

LIQUID MASK

4.) INTERIOR COLOR

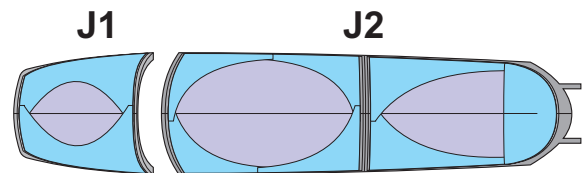

5.) RUBBER COLOR

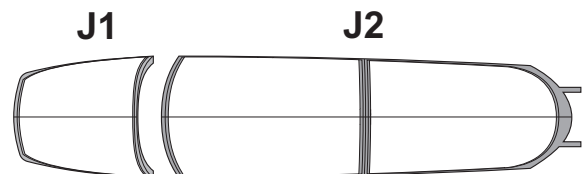

6.) REMOVE MASK

7.)

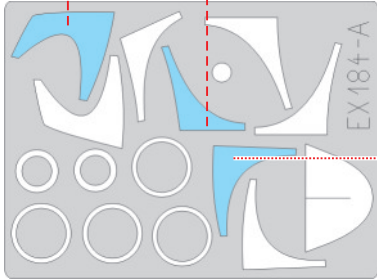
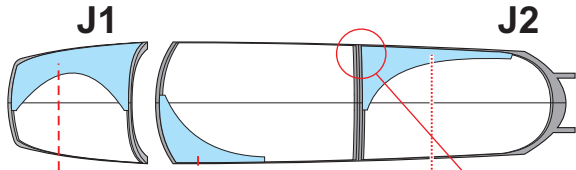

8.)

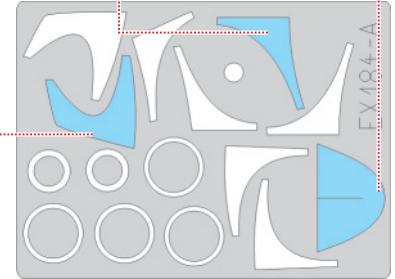
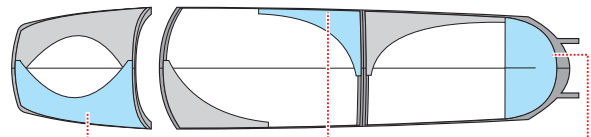

9.)

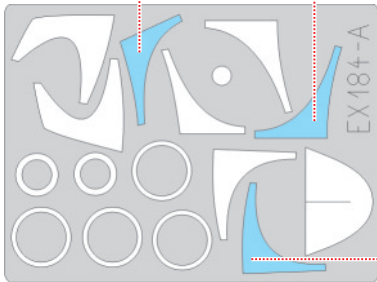
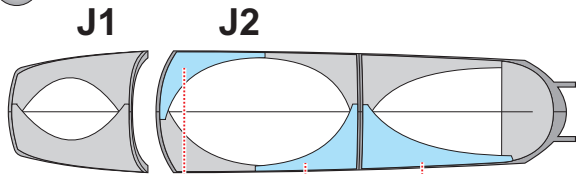

10.)



CAMOUFLAGE COLOR

J1

J2

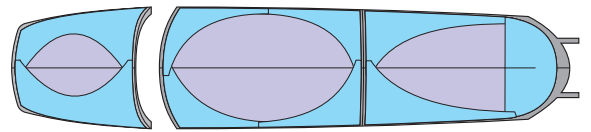

LIQUID MASK

C11

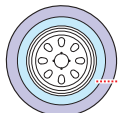

2pcs

C12

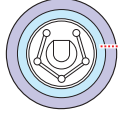

2pcs

N1

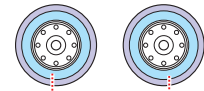

J4

