

1/35 MILITARY MINIATURE VEHICLE UPGRADE SERIES PE351096

Modern US Army M109 155mm L23 Self-propelled howitzer

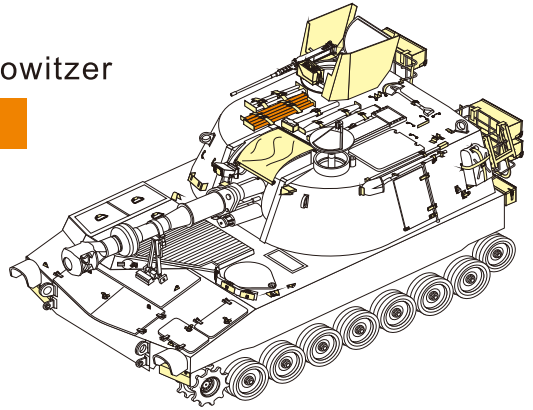







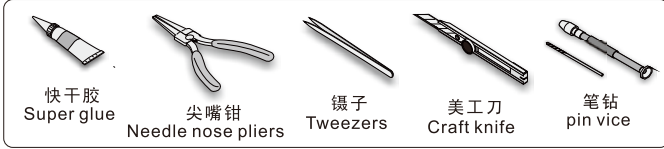

现代美军 M109 155mm L23自行榴弹炮改造基本件

[For AFV35329]



推荐使用工具 RECOMMENDED TOOLS



- 
安装
install
- 
折叠
bend
- A1**
 改造件零件编号
PE/resin part number
- B12**
 原零件编号
kit part number
- G22**
 被替换的原零件编号
replaced kit part number
- 
切除
remove
- 
打磨
grind off
- 
弧度卷曲
radial bending
- 
钻孔
drill
- 
注意
caution
- 
扩孔
ream
- x2**
 制作若干组
multiple assembly
- 
填补
fill
- 
选择安装
alternative
- 
另一侧相同制作
repeat on opposite side

 用尖端在凹槽处冲压
use penpoint to press on the dent

蚀刻片零件内侧面向上
Put the part upside down
用笔尖在凹槽处刺
Use penpoint to press on the dent

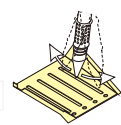

 制作线圈
make coil

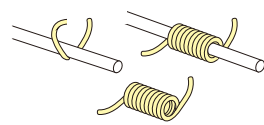
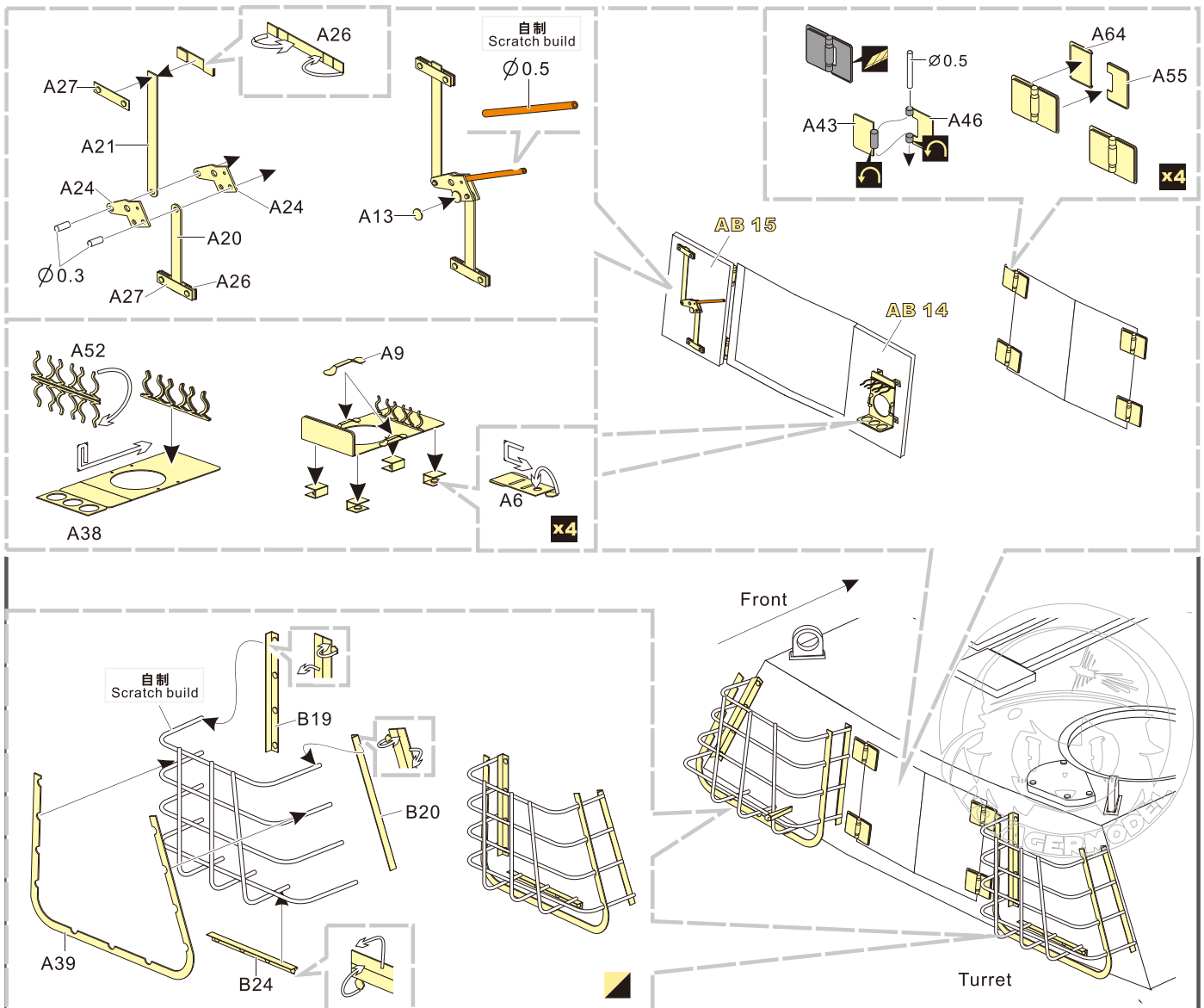
1/35 MILITARY MINIATURE VEHICLE UPGRADE SERIES PE351096

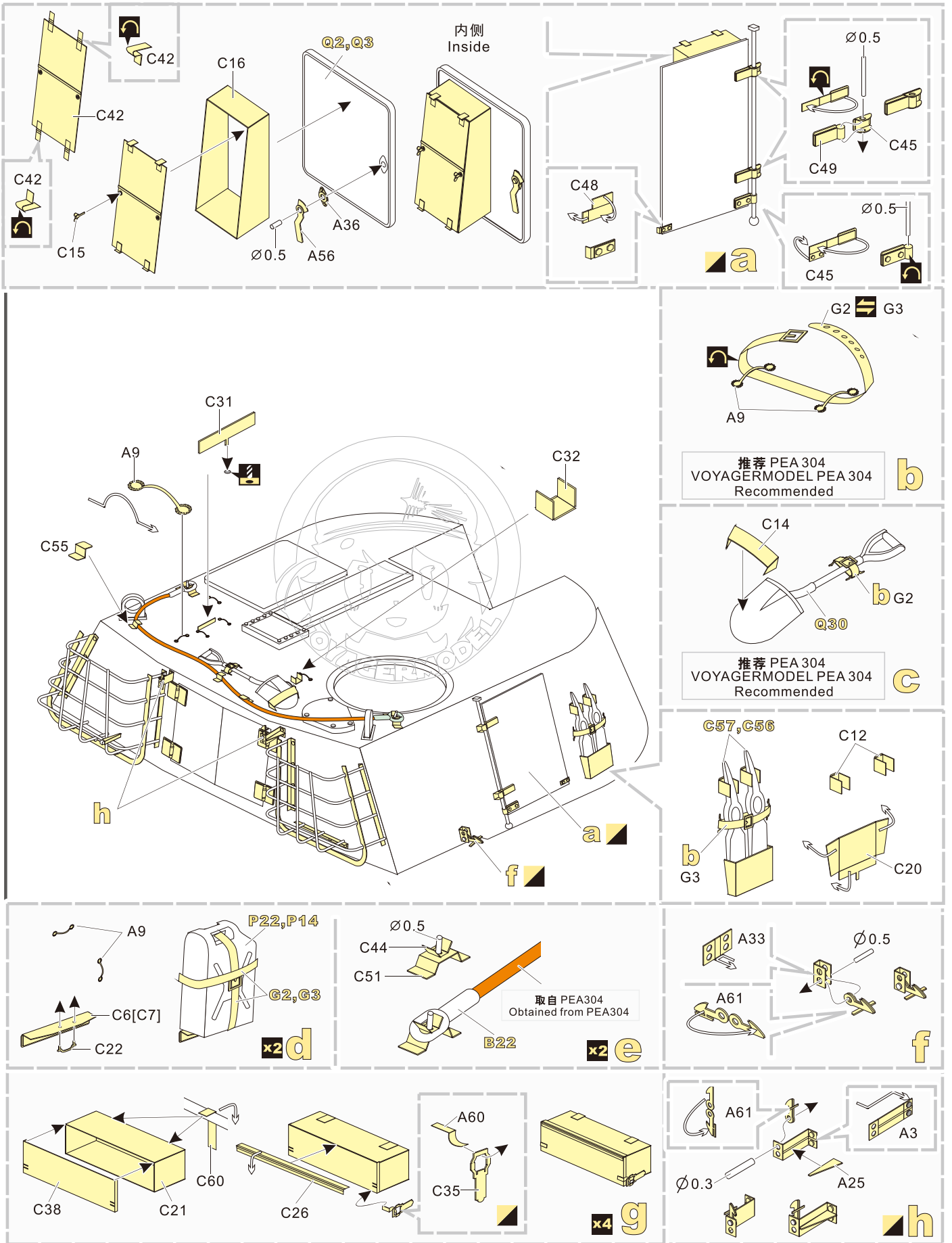

1/35 MILITARY MINIATURE VEHICLE UPGRADE SERIES PE351096

推荐 PEA 304
VOYAGERMODEL PEA 304
Recommended

推荐 PEA 304
VOYAGERMODEL PEA 304
Recommended

推荐 VBS0209
VOYAGERMODEL VBS0209
Recommended

自制
Scratch build

切取自套件
Removed from kits part

Ø0.5

Ø1.0

Ø0.5

Ø0.5

Ø0.5

Ø0.5

VOYAGERMODEL

j **k** **l** **m**

1/35 MILITARY MINIATURE VEHICLE UPGRADE SERIES PE351096

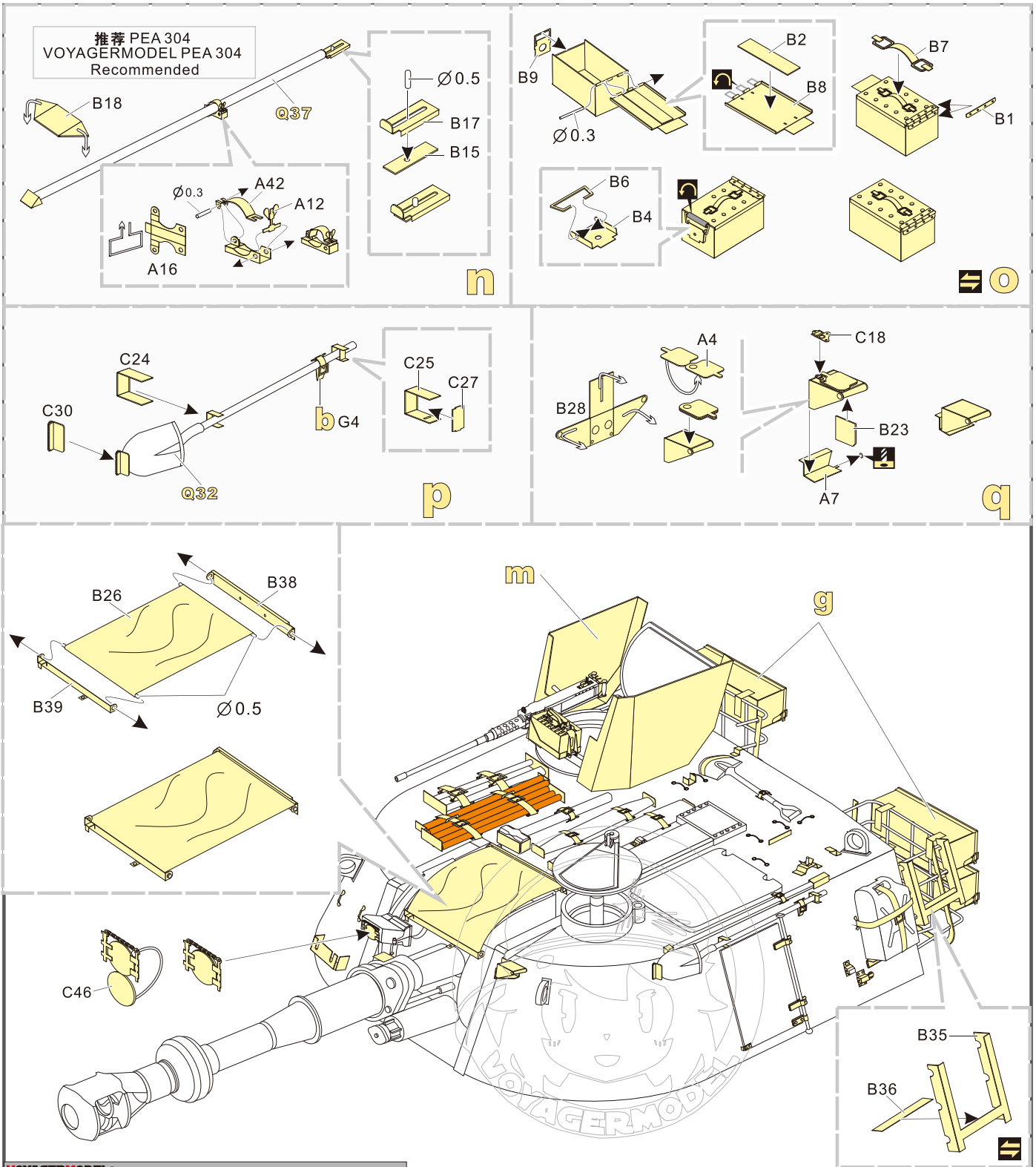

推荐 PEA 304
VOYAGERMODEL PEA 304
Recommended

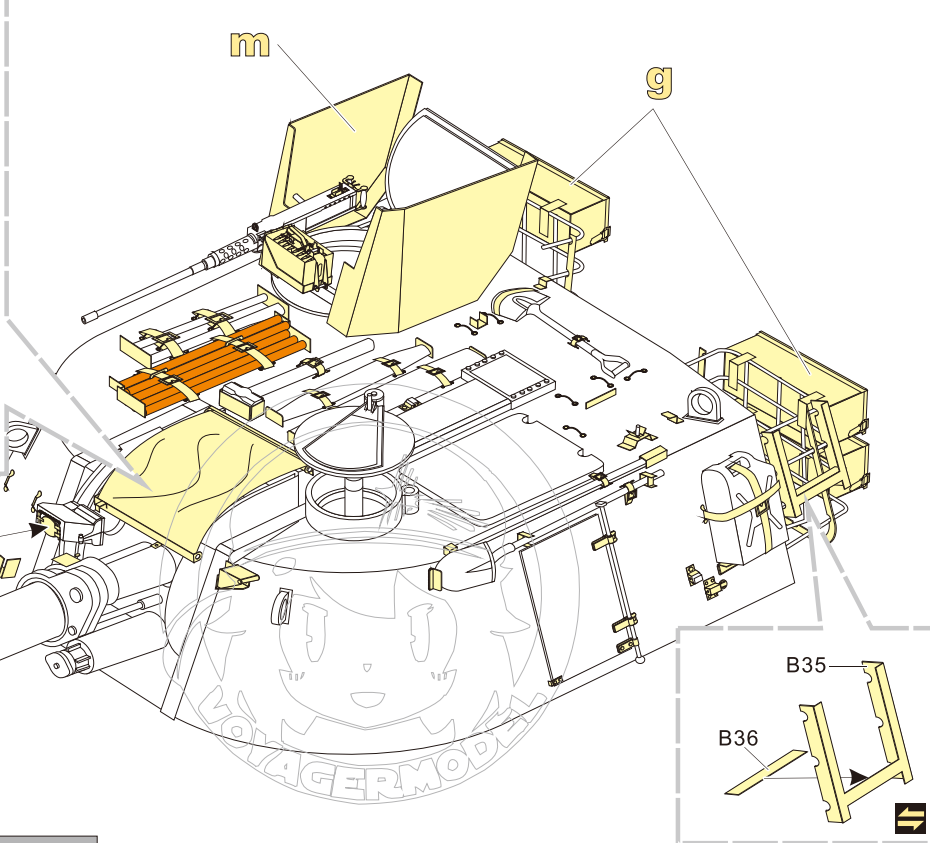
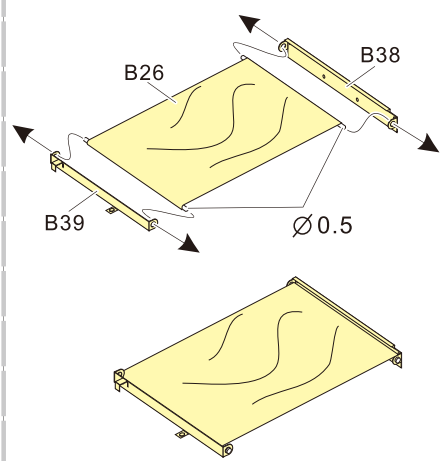
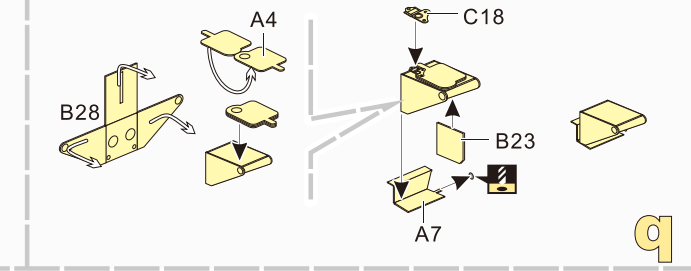
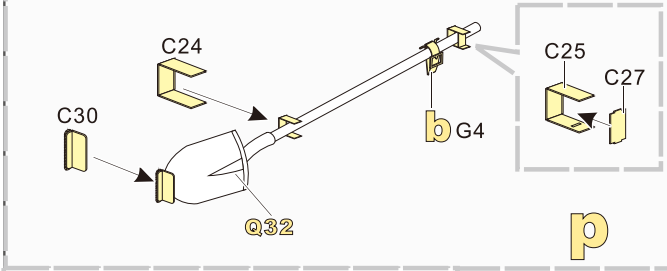
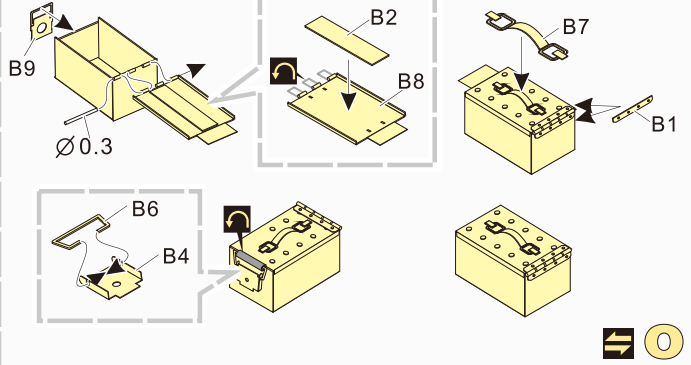
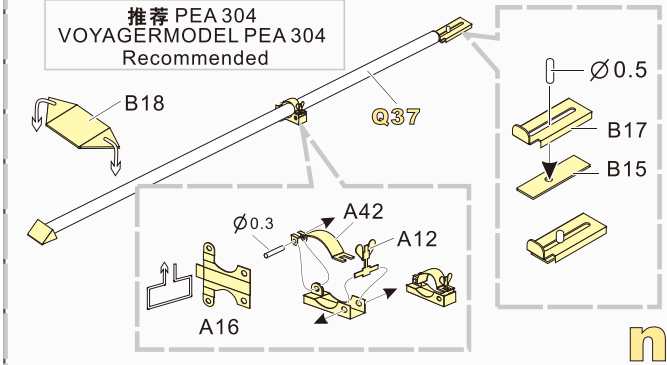

VOYAGERMODEL® 无缝不歪 极致享受

Recommended item

PEA304	Modern US Army M109 Self-propelled howitzer add parts
PE 35540	Modern US Army M109A2 Self-propelled howitzer
PE 35541	Modern US Army M109A6 Self-propelled howitzer
PE 35550	Modern US Army M109A2 Self-propelled howitzer
PE 351027	Modern US Army M109A7 Self-propelled howitzer
PE 35540	Modern US Army M109A2 Self-propelled howitzer
PE 35541	Modern US Army M109A6 Self-propelled howitzer
PE 35550	Modern US Army M109A2 Self-propelled howitzer
PE 35629	Modern US Army M109A6 Self-propelled howitzer
VBS 0212	Modern US Browning M2HB GP Machine Gun & Optical collimator set
BR 35109	Modern US Army M109A6 SPH Lenses and taillights

漏喷板使用说明:
Instruction:

未上色零件
Unpainted part

喷橡胶黑
spray tyre black

使用漏喷板为轮毂
喷上所需要的颜色
use template to paint
required hub colour

完成
Completed part

1/35 MILITARY MINIATURE VEHICLE UPGRADE SERIES PE351096

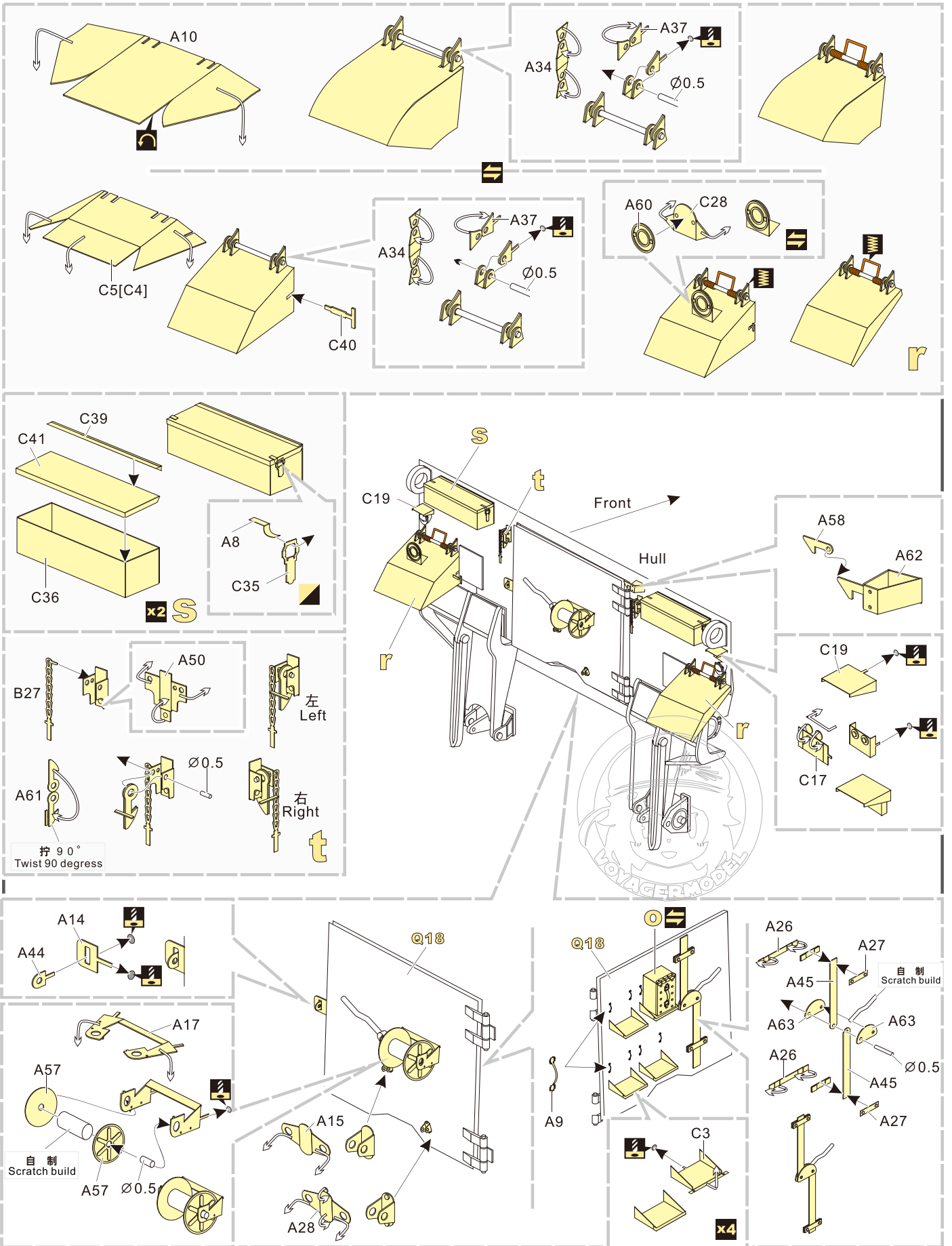

1/35 MILITARY MINIATURE VEHICLE UPGRADE SERIES PE351096

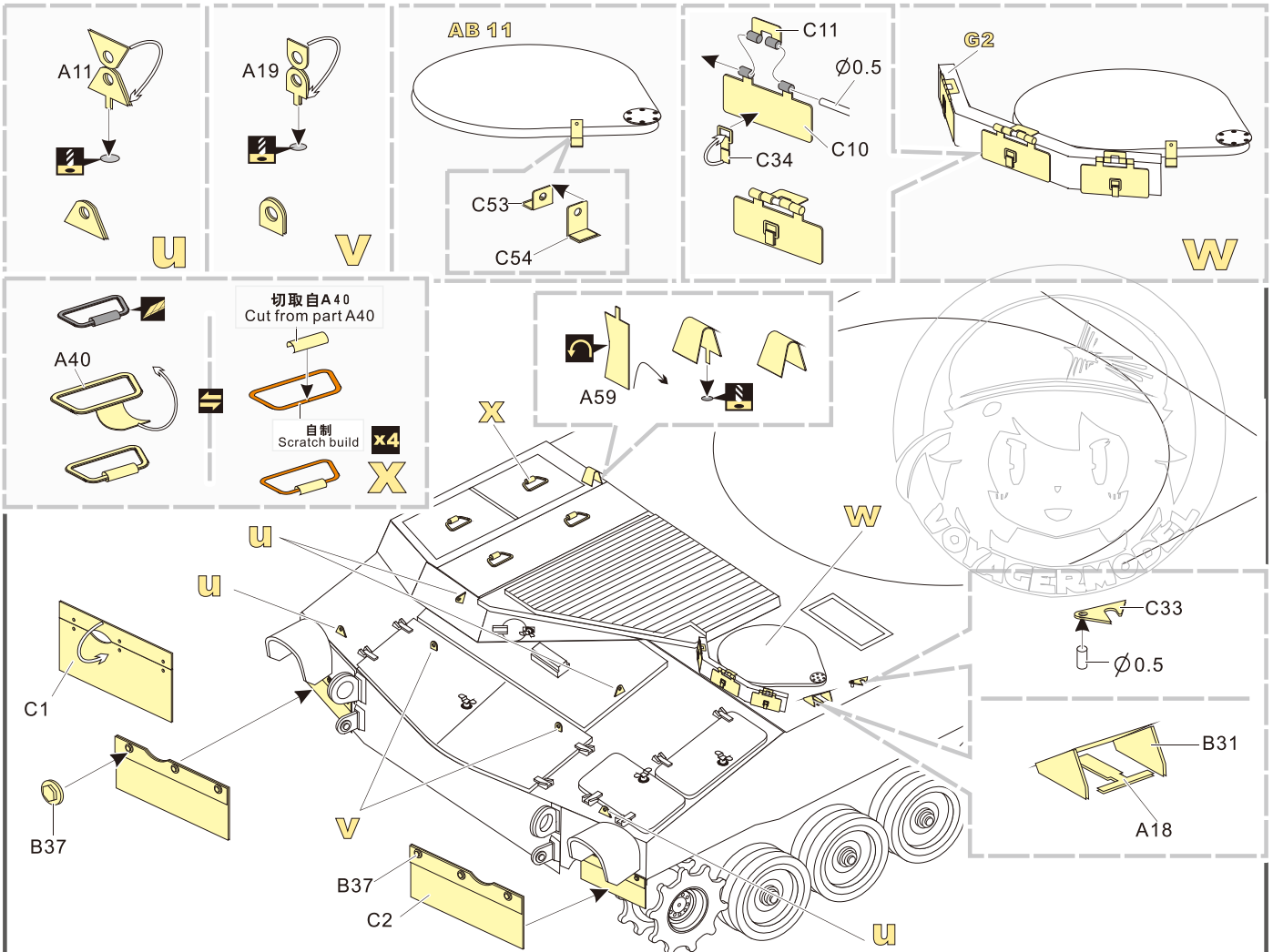

[Http://www.voyagermodel.com/productdetails.asp?itemid=PE351096](http://www.voyagermodel.com/productdetails.asp?itemid=PE351096)

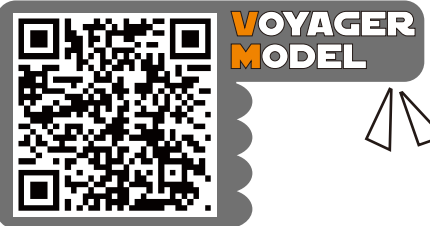

更多PE351096样品照片参考请扫一扫
MORE PICTUER OF PE 351096
REFERENCE SCAN HERE

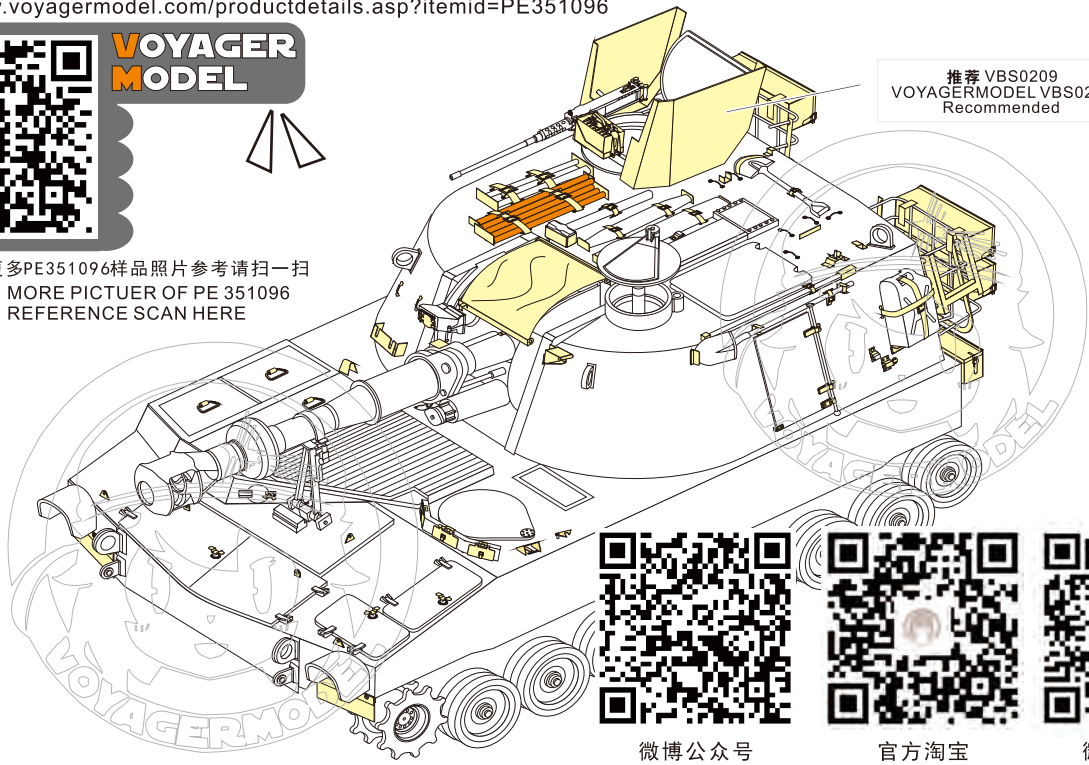

推荐 VBS0209
VOYAGERMODEL VBS0209
Recommended



微博公众号



官方淘宝



微信公众号