

1:144 Scale

ITEM NO.: 01317

# F-22A Raptor

美国F-22A 猛禽战斗机

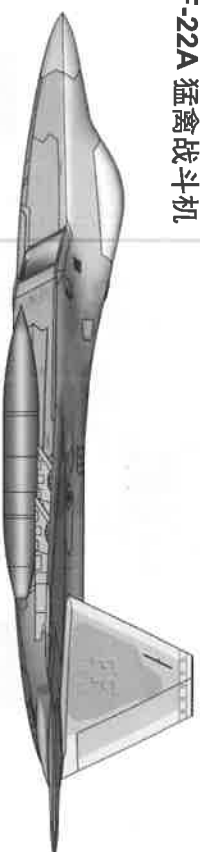





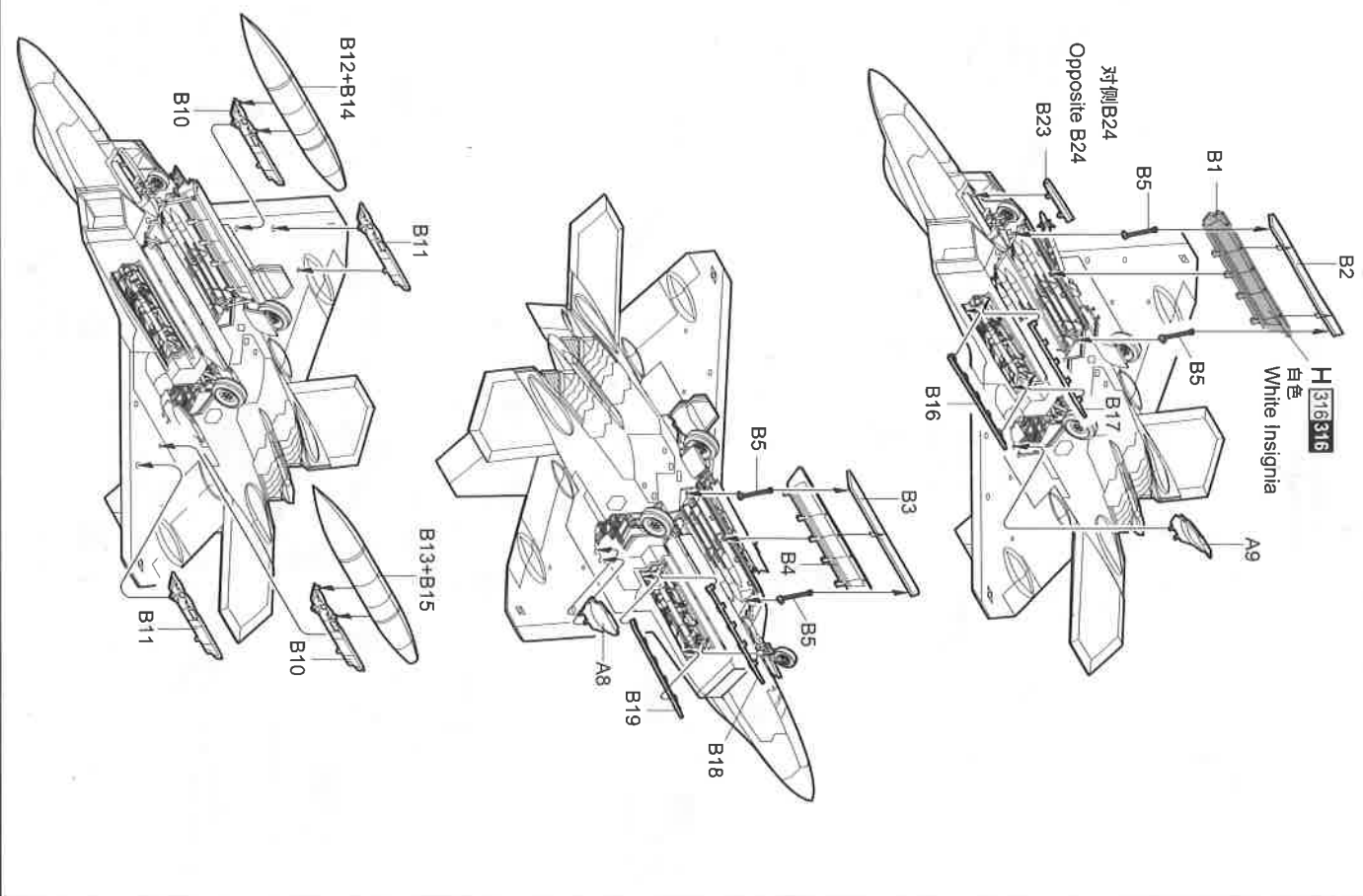



### 装配之前仔细阅读

- READ BEFORE ASSEMBLY:**
- Study and understand these instructions thoroughly before beginning assembly
  - When needed, remove photo-etch parts carefully using a modeling knife or photo etch sprue cutter, being careful not to damage or lose small parts.
  - Take extra care in handling photo etch parts in order to avoid injury
  - Apply instant cement sparingly to photo etch parts where instructed
  - Tools recommended(not included in kit):Plastic and instant cements,sprue cutters,long nose pliers,modeling knife, small files, tweezers, pin vise & scissors. Soft cloth and sandpaper will also assist in construction
  - Glue and paint are not included in the kit. Use plastic cement and hobby paints only. Color guide for purchasing paint is included in the kit.
- 装配之前仔细阅读**
- 小心用模型锉刀锉平所有零件表面的注射浇口。
  - 小心用刀片切下蚀刻片零件，不要丢失小零件。
  - 用强力快干胶水粘合蚀刻片零件和金属轴，过量的快干胶水使用可能导致可动零件会粘住，小心涂胶。
  - 取蚀刻片时应特别注意安全，防止利边划伤手指。
  - 某些零件表面需贴上火贴纸，请选择在装配的同时进行。
  - 推荐模型工具(自备)：胶水、水口剪刀、长咀钳、刀片、镊子、钳、钻、剪刀、瞬间快干胶。
  - 软布同砂纸同时也应该是必备工具。
  - 请使用塑料胶水和油漆，模型内不含。



01317

4

				
Cyanoacrylate glue 使用强力胶	weight 配重	make hole 钻孔	cut / remove 切除	bend 弯曲
				
file / sand 锉平	option 选择	no cement 不涂胶水	decal 贴纸	

### 水贴纸的使用:

1. 从水贴纸上剪下印花;
2. 将印花放入温水中浸10秒，然后放在干净布上。
3. 拿着印花纸板将印花移到模型上;
4. 手指蘸水将印花移到适当的位置;
5. 用软布轻压印花直至水干，气泡消失。

### DECAL APPLICATION

1. Cut off decal from sheet.
2. Dip the decal in tepid water 40°C for about 10 sec. and place on a clean cloth.
3. Hold the backing sheet edge and slide decal onto the model.
4. Move decal into position by wetting decal with finger.
5. Press decal gently down with a soft cloth until excess water and air bubbles are gone.
6. Allow decal to dry completely before handling model.

01317

1

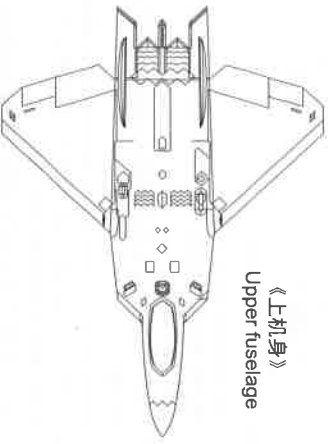
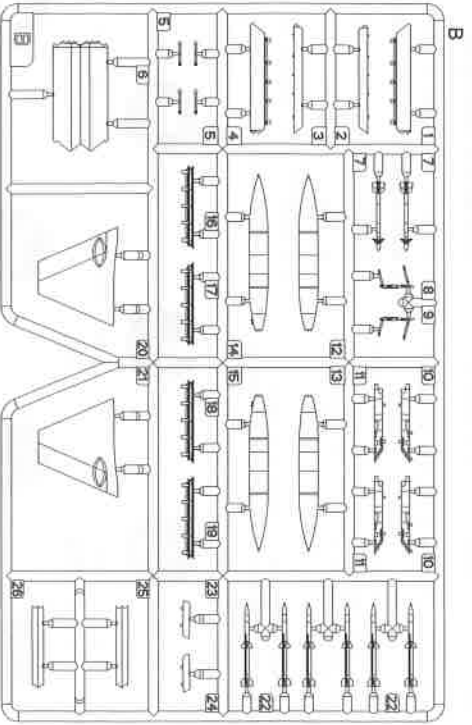
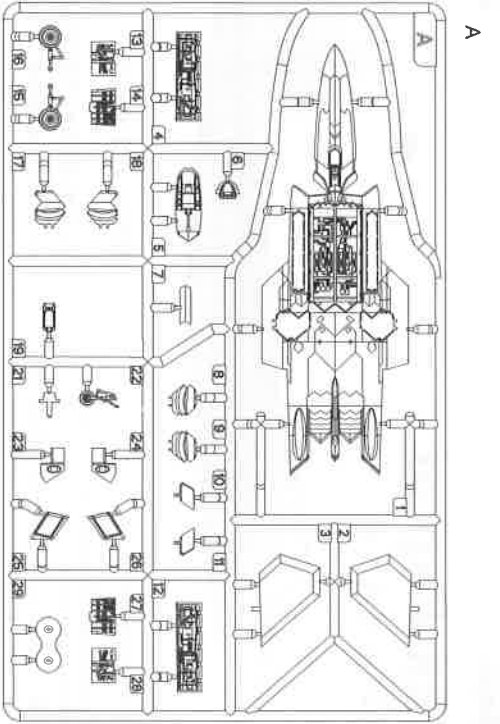

01317

2

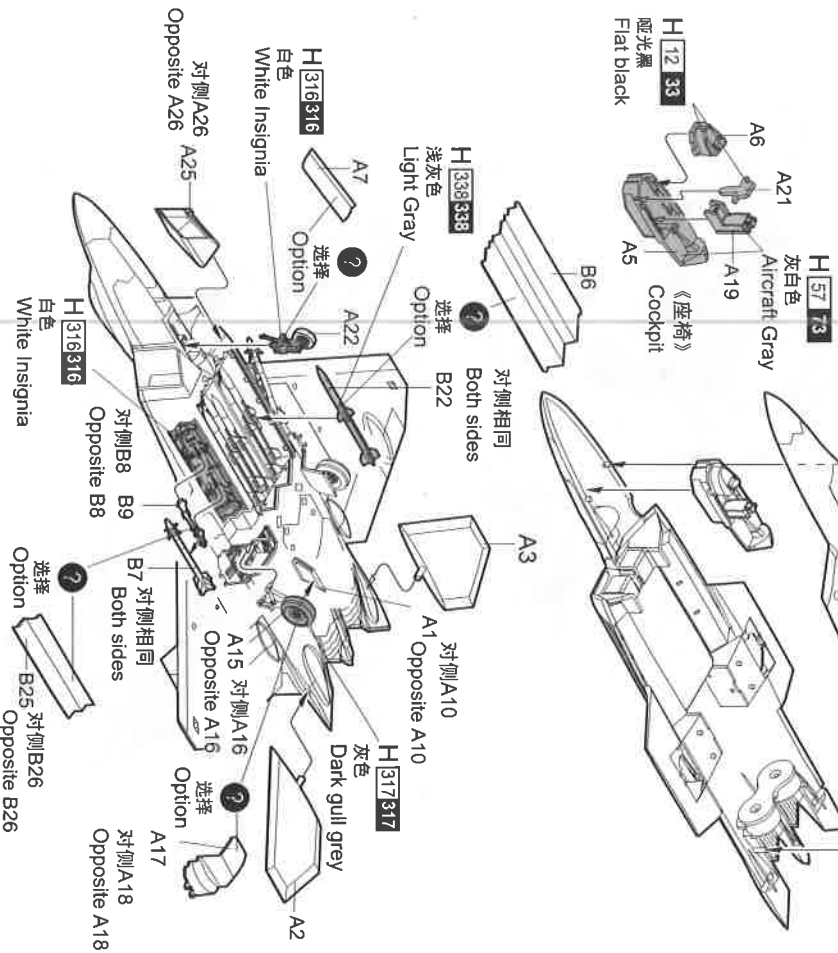
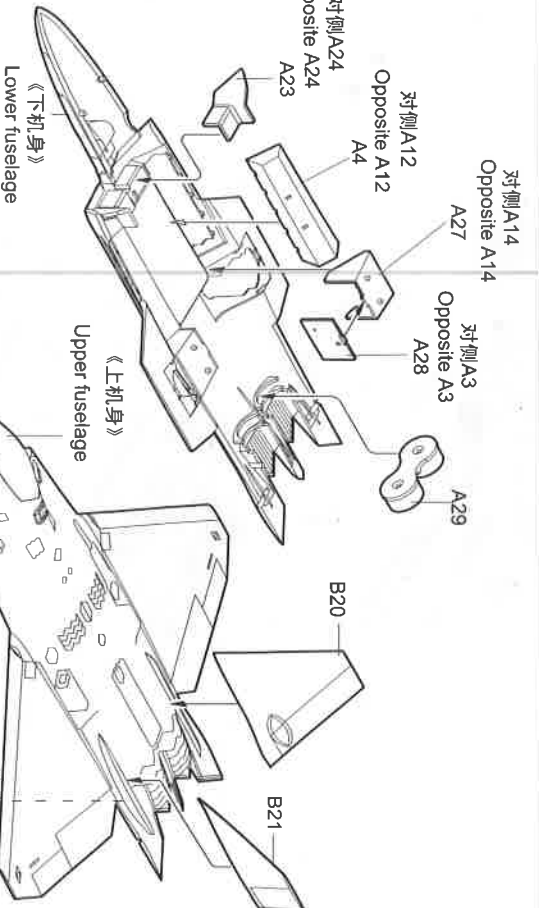

01317

3

# 涂装同标贴指示 Painting & Marking guide

Color	Mr.Hobby	Vallejo	Model Master	Tamiya	Humbrol
Dark Compas Ghost Gray 灰色	H 307 307	—	1741	XF22	128
Gray 灰色	H 308 308	990	1727	XF19	127
Light Gray 浅灰色	H 338 338	907	1732	XF14	147

**A**

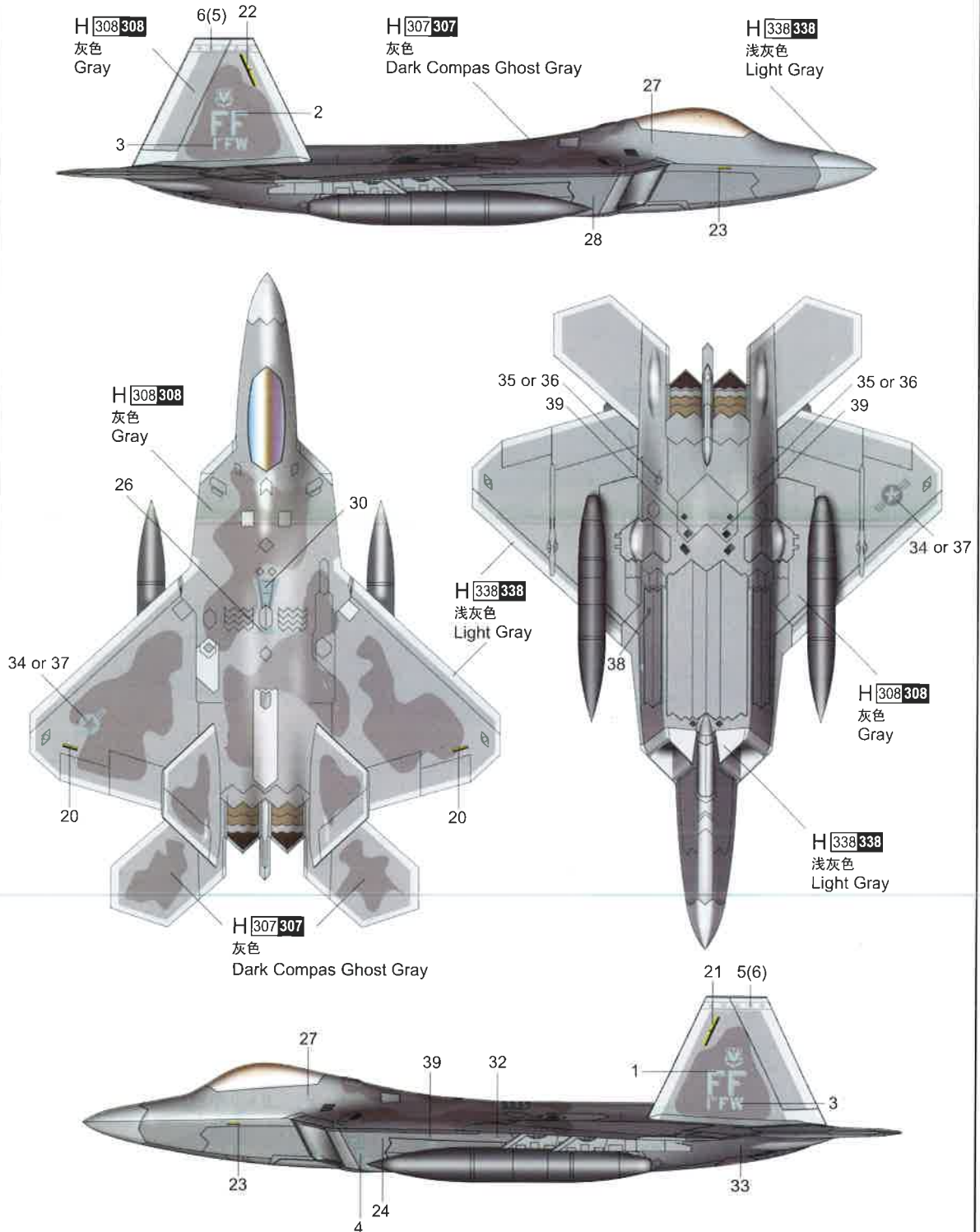

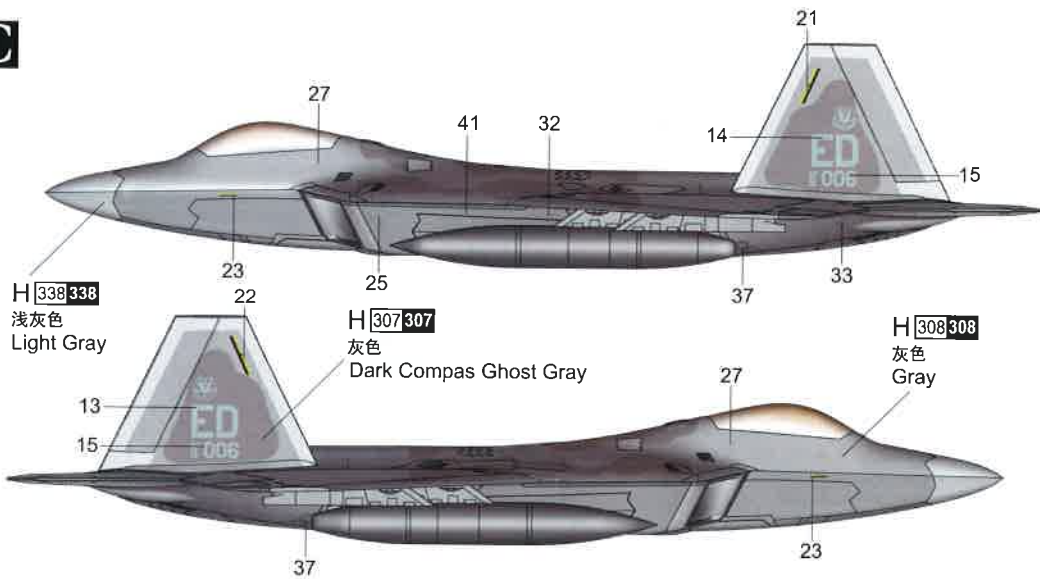
**B****C****D**