









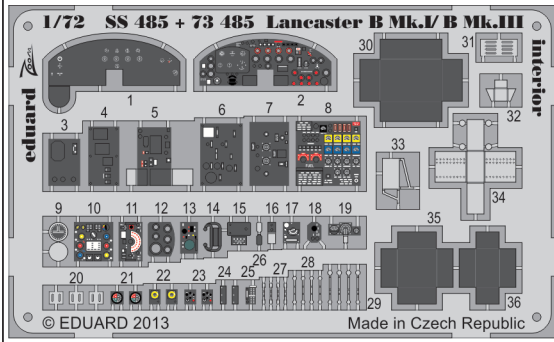

SS485





Lancaster B Mk.I/B Mk.III interior S.A.



1/72 scale detail set for Airfix kit • sada detailů pro model Airfix 1/72



-  SYMMETRICAL ASSEMBLY
SYMETRICKÁ MONTÁŽ
-  REMOVE
ODSTRANIT
-  BEND
OHNOUT
-  REPLACE
NAHRADIT
-  GRIND
OBROUSIT
-  OPTION
VOLBA
-  **1** COLORED ETCHED PARTS
LEPTANÉ BAREVNÉ DÍLY

-  ORIGINAL KIT PARTS
PŮVODNÍ DÍLY STAVEBNICE
-  PHOTO-ETCHED PARTS
LEPTANÉ DÍLY
-  PARTS TO BE REMOVED
DÍLY K ODSTRANĚNÍ
-  FILL
TMELIT

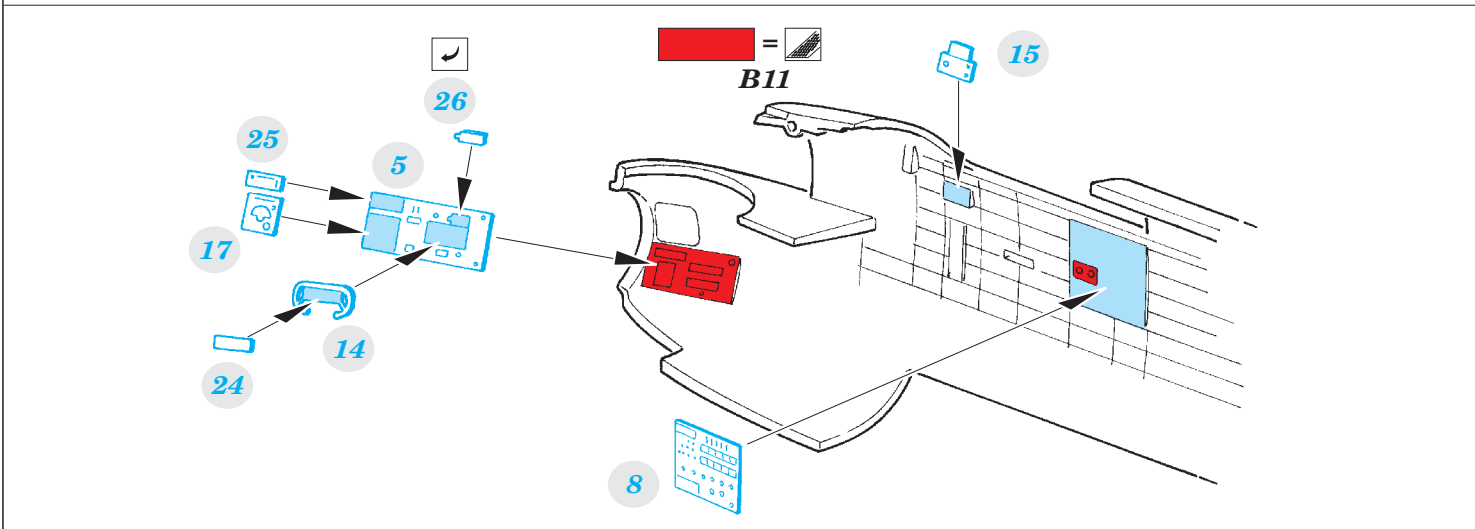
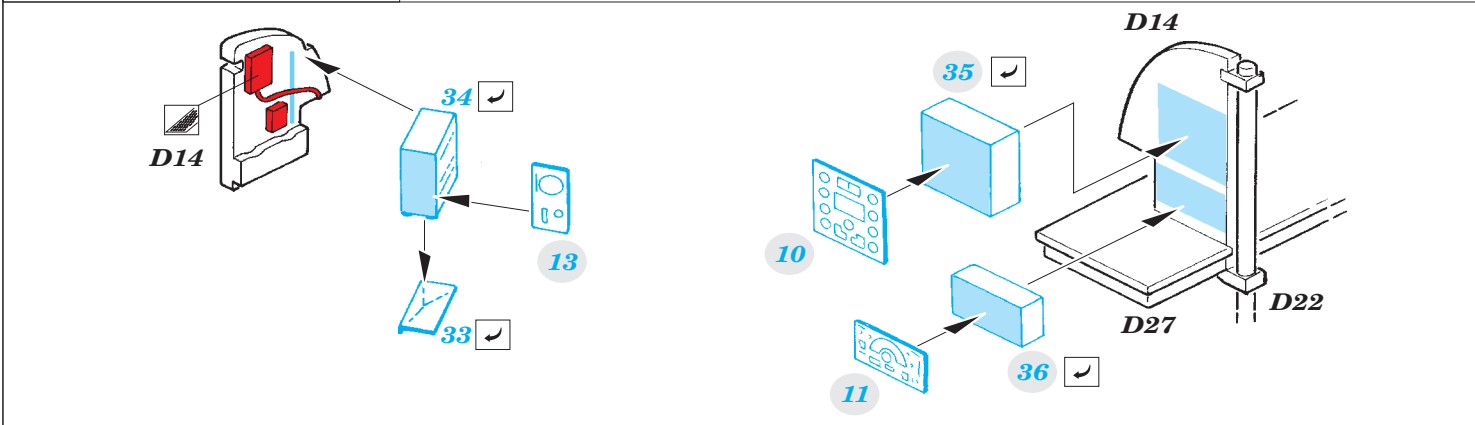
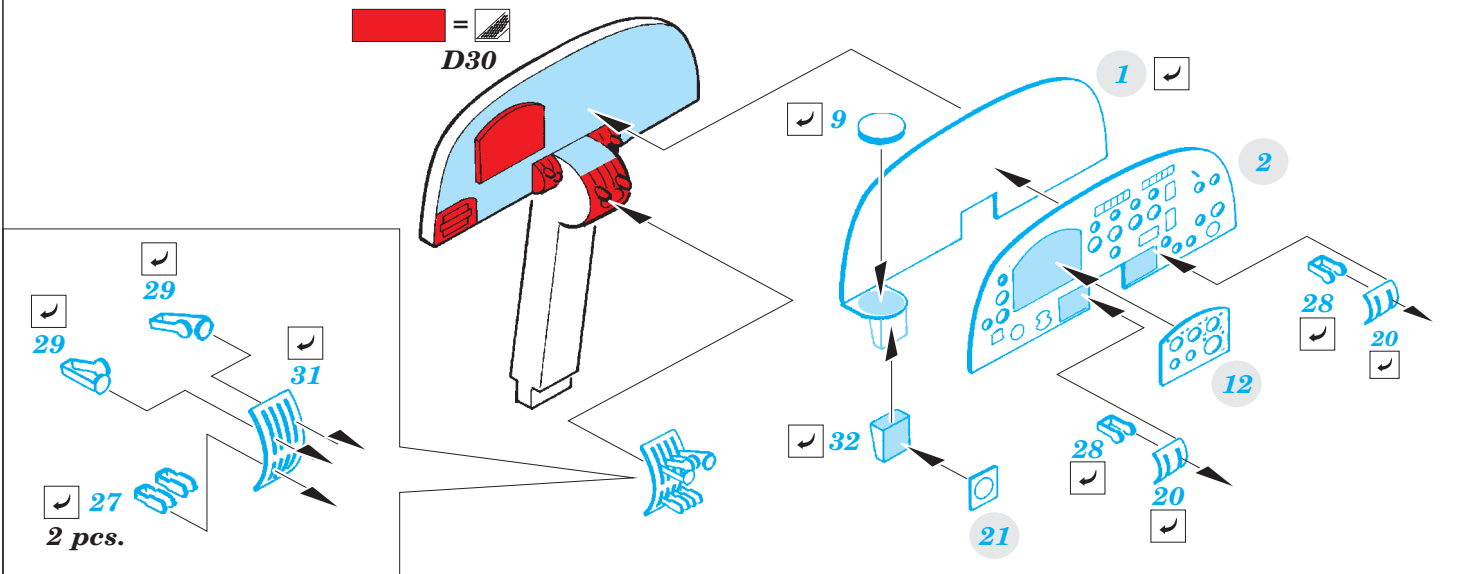

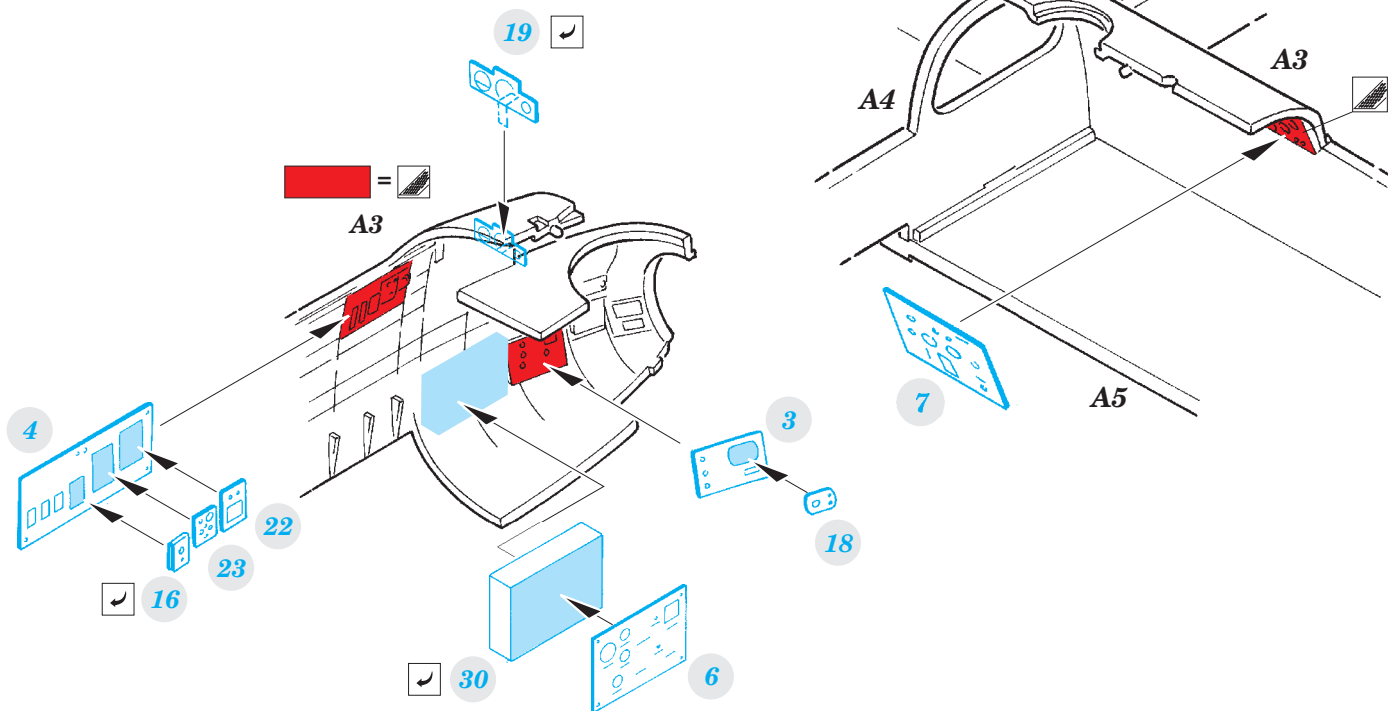

PARTS WITH GLUE • DÍLY OPATŘENÉ LEPIDLEM

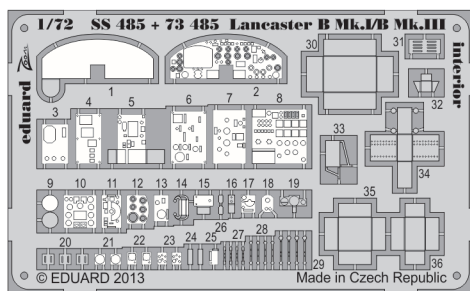

- Do not touch the adhesive areas of the etched components.
- Nesahejte na části dílů, na kterých je naneseno lepidlo.

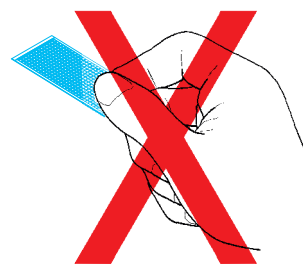

- Separate the etched components from their frames on the protective paper. Removal from the paper is done only after separation of the parts from the frames.

- Samolepící díly oddělujte od rámečku na podkladovém papíře. Po oddělení je sejměte z krycího papíru.

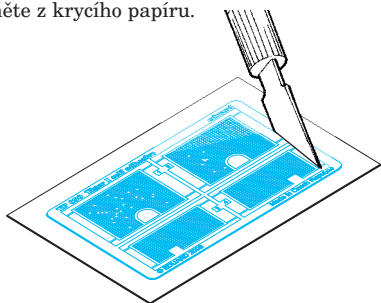

- Do not inadvertently place etched components on an unwanted surface. Attempts to remove will result in damage to your part.
- Nepokládejte samolepící díly na volné plochy. Pokud je omylem přilepíte, při pokusu o odlepení dojde k poškození dílu.

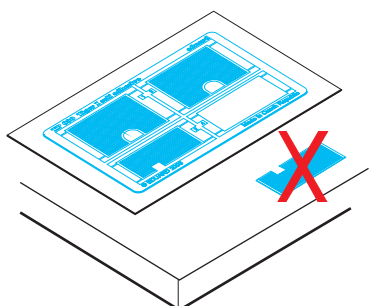

- Hold the parts by the edges, or at areas free of adhesive.
- Samolepící díly berte za hrany nebo za části, na kterých není nanesené lepidlo.

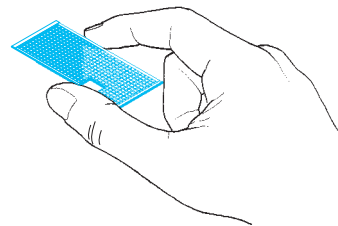

- Lightly place the component in the desired location and position. Adjust as required. The component will be permanently affixed when pressed onto its intended location, its location can be adjusted.
- Díl lehce položte do pozice, ve které má být nalepen. Upravte přesnou pozici a přimáčkněte. Díl dokonale přilne až po přimáčknutí, před přimáčknutím lze dílem opatrně manipulovat.

