

Me 262 V056 Stage 2

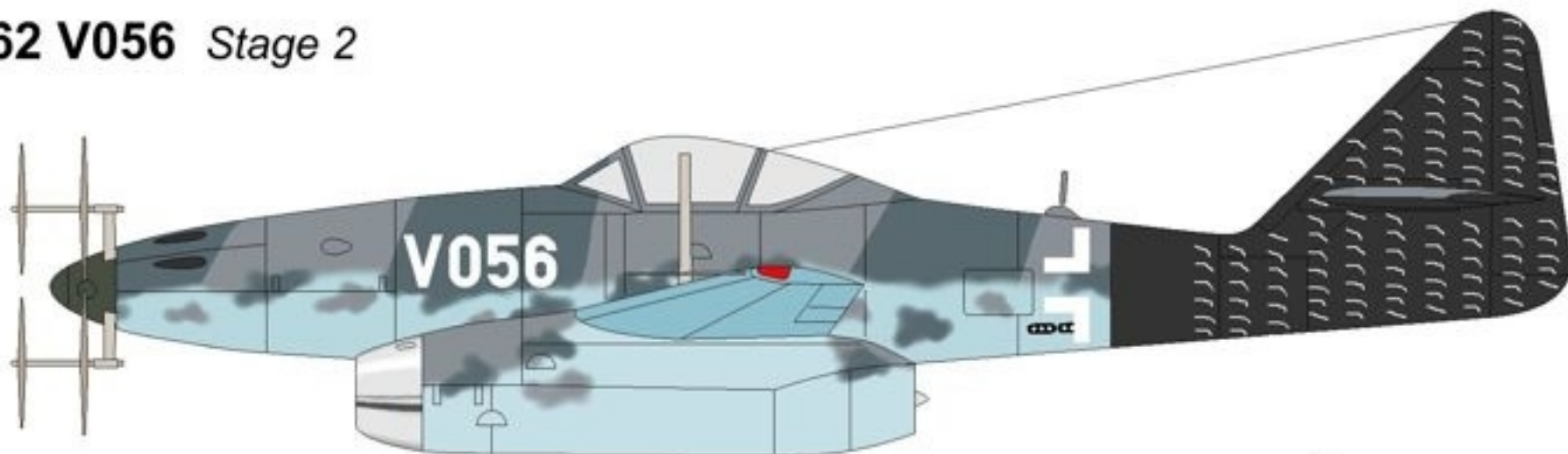

FuG 218 "Neptun V X"
"streamlined version"

FuG 226 "Neuling"

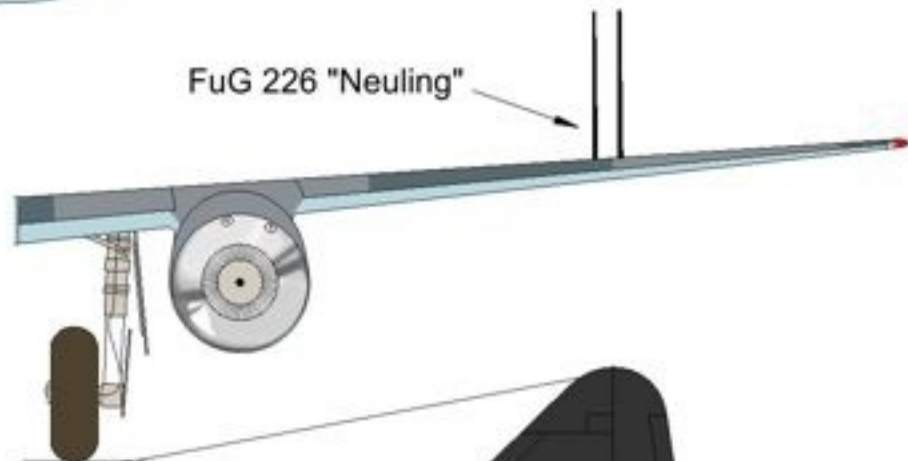

Me 262 V056 Stage 1

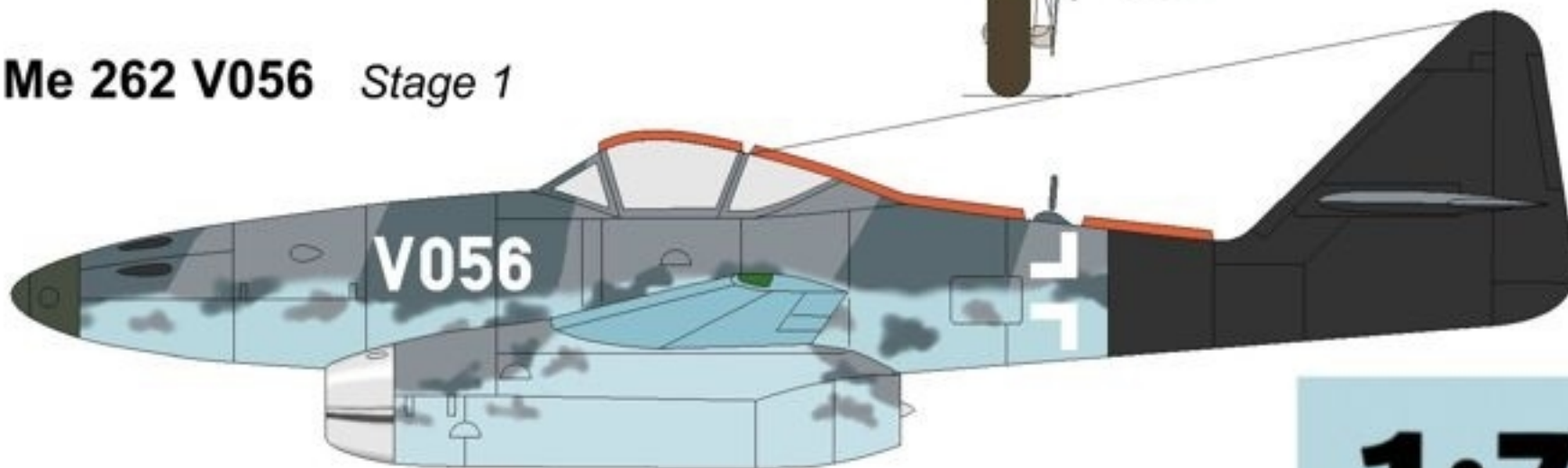

1:72

**AM-6010 Messerschmitt Me 262 V056
Night Fighter testbed conversions**

- | | | | |
|---|--|---|--|
|  RLM 76 |  aluminum |  RLM 75 |  RLM 70 |
|  RLM 02 |  RLM 23 |  RLM 74 |  black |

Airmodel Products
Hörsteiner Weg 1
63500 Seligenstadt

Tel.: +49 6182 899899
<http://www.airmodel.de>
info@airmodel.de

**Me 262 V056
Stage 2**

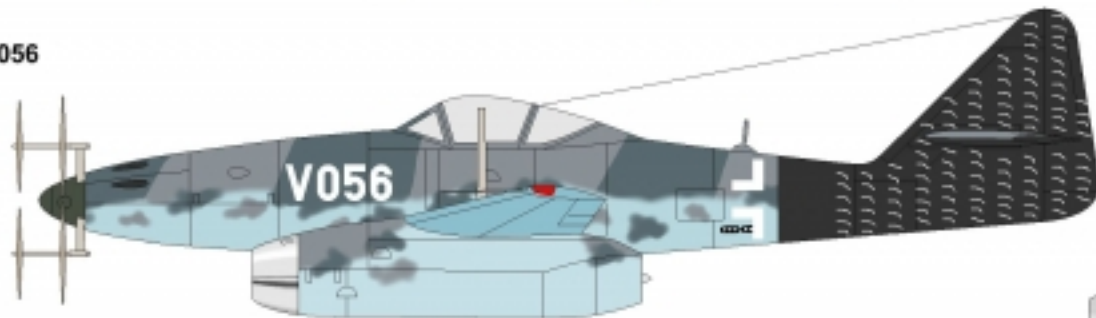

FuG 218 "Neptun V X"
"streamlined version"

FuG 226 "Neuling"

FuG 218 "Neptun V X"
"streamlined version"

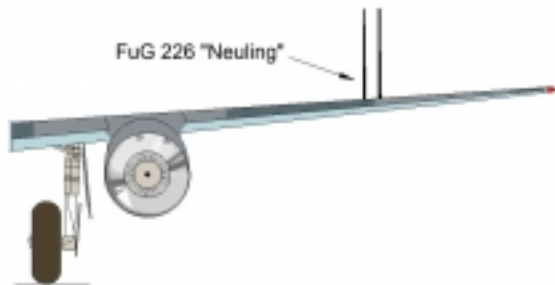

**Me 262 V056
Stage 1**



**Me 262 V056
Stage 3 a/b**

Flighttests with and
without FuG 226

Flighttests with and
without small dorsal fin

170056



FuG 218 "Neptun V1" early 1943 to end of the war

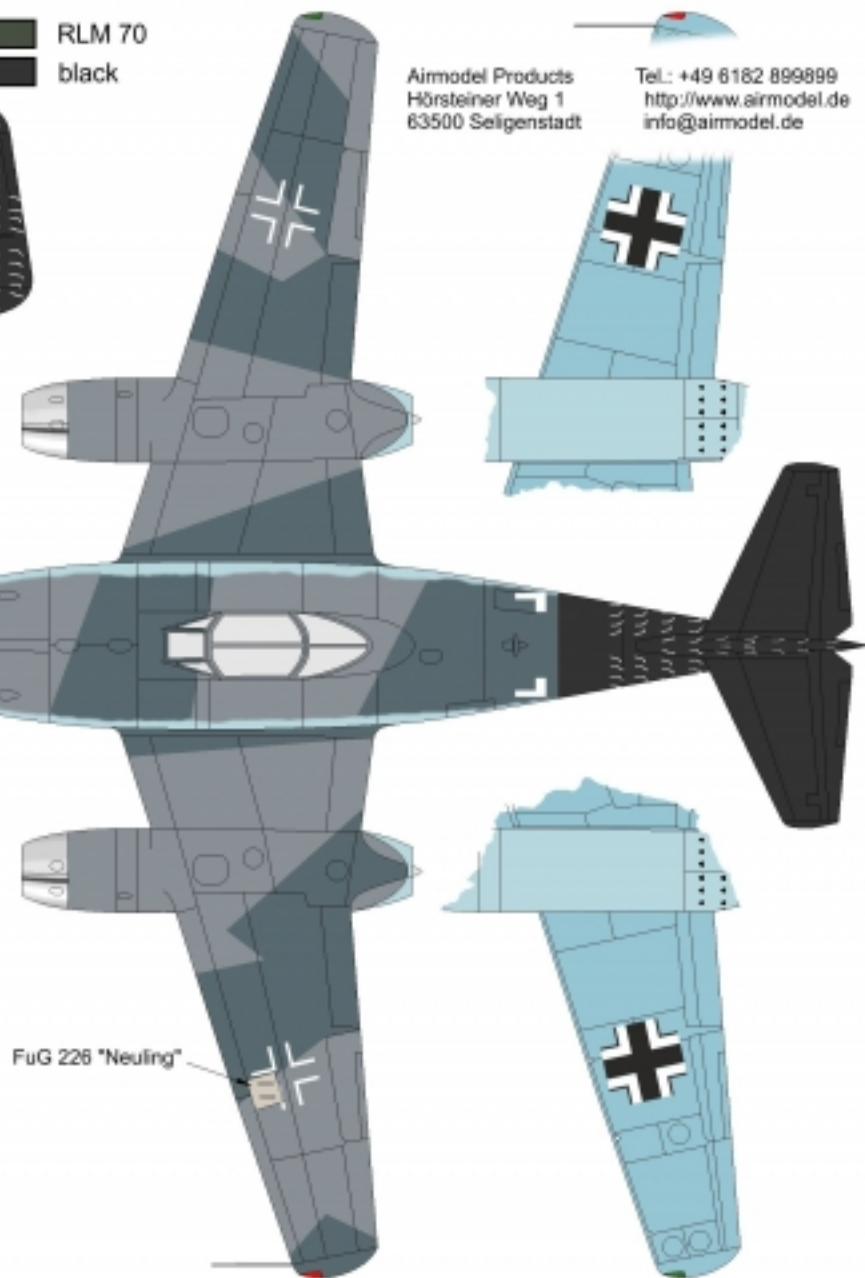

FuG 226 "Neuling"

170056
170056

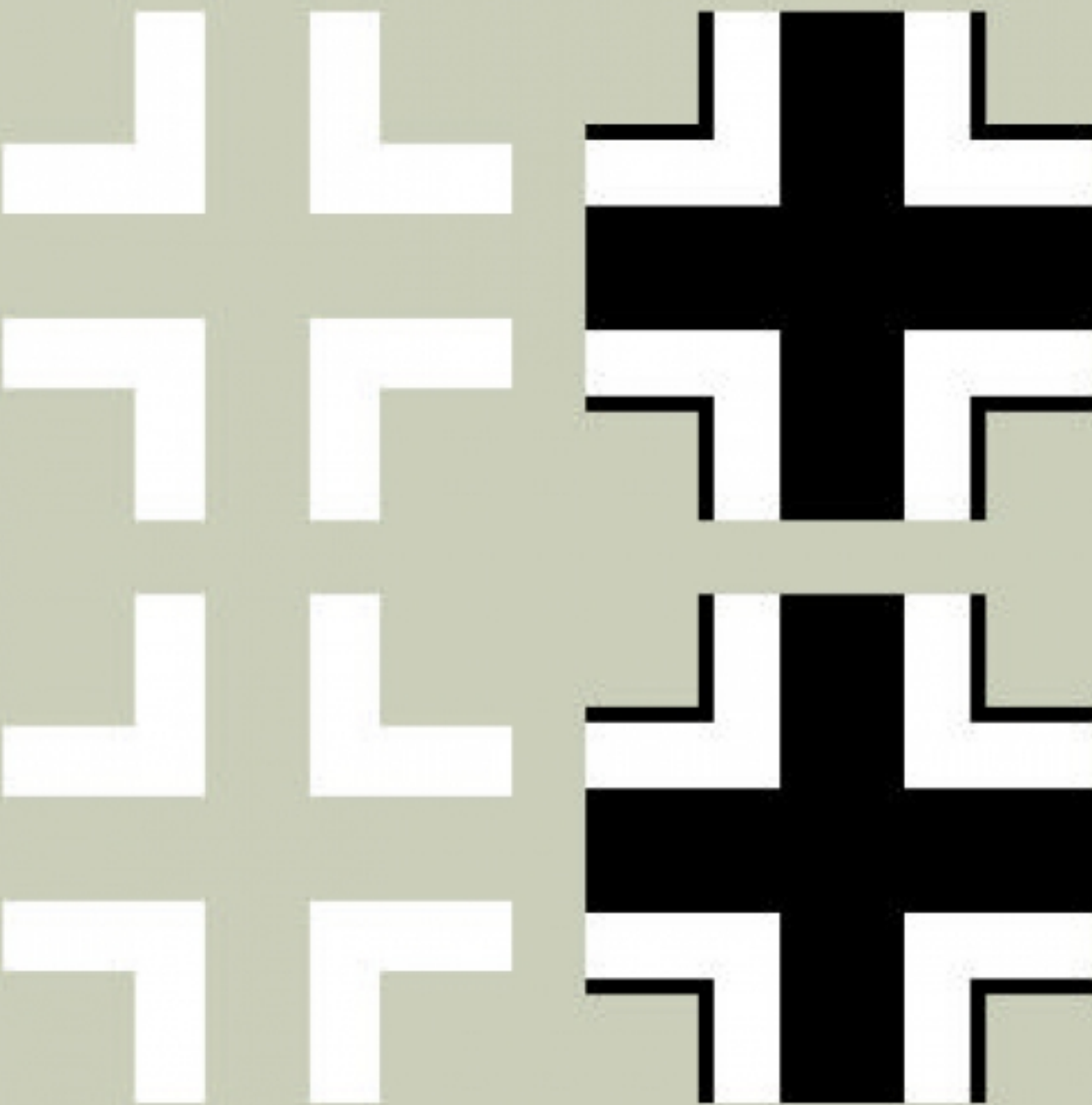

V056 V056

AM-6010 Me 262 V056 Variants