

Messerschmitt Bf 109

G-6, G-6/Trop, G-6 Erla

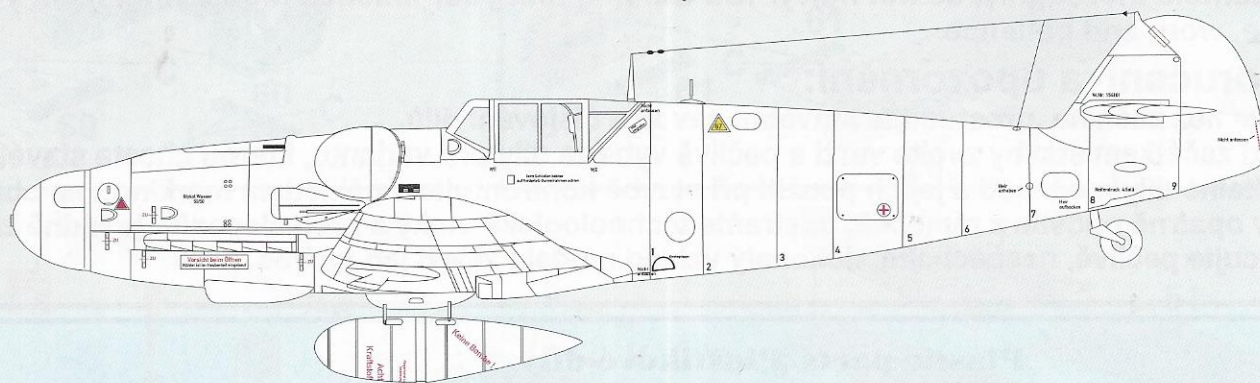

History in brief

The Messerschmitt Bf 109, often called Me 109 (most often by Allied pilots and aircrew), was a German World War II fighter aircraft designed by Willy Messerschmitt and Robert Lusser during the early to mid-1930s. It was one of the first truly modern fighters of the era, including such features as all-metal monocoque construction, a closed canopy, a retractable landing gear, and was powered by a liquid-cooled, inverted-V12 aero engine.

The Bf 109 first saw operational service during the Spanish Civil War and was still in service at the dawn of the jet age at the end of World War II, during which time it was the backbone of the Luftwaffe's fighter force. From the end of 1941 the Bf 109 was supplemented by the Focke-Wulf Fw 190. Originally conceived as an interceptor, later models were developed to fulfill multiple tasks, serving as bomber escort, fighter-bomber, day-, night-, all-weather fighter, ground-attack aircraft, and as reconnaissance aircraft. It was supplied to and operated by several states during World War II, and served with several countries for many years after the war. The Bf 109 was the most produced fighter aircraft in history, with a total of 33,984 airframes produced from 1936 up to April 1945.

The Bf 109 was flown by the three top-scoring German fighter aces of World War II, who claimed 928 victories among them while flying with Jagdgeschwader 52, mainly on the Eastern Front, as well as by Hans-Joachim Marseille, the highest scoring German ace in the North African Campaign. It was also flown by several other aces from Germany's allies, notably Finn Ilmari Juutilainen, the highest scoring non-German ace on the type with 58 victories flying the Bf 109G, and pilots from Italy, Romania, Croatia, Bulgaria and Hungary. Through constant development, the Bf 109 remained competitive with the latest Allied fighter aircraft until the end of the war.

Historie

Messerschmitt Bf 109, často nazývaný Me 109 (většinou spojeneckými piloty a posádkami), byl německý stíhací letoun z období II. světové války zkonstruovaný Willy Messerschmittem a Robert Lusserem v pol. 30.let minulého století. Byl to jeden z prvních skutečně moderních stíhacích strojů své doby, vyznačující se celokovovou skořepinovou konstrukcí, uzavřenou kabinou a zatahovacím podvozkem. Byl poháněn kapalinou chlazeným 12ti válcovým invertním motorem. Poprvé byly Bf 109 operačně nasazeny během španělské občanské války a byl stále v provozu až do úsvitu proudového věku na konci druhé světové války. Koncem roku 1941 byl Bf 109 postupně nahrazován Focke-Wulfem Fw 190. Původním určením byl přepadový stíhač, později byly vyvinuty různé nové verze, které sloužily jako doprovod bombardérů, stíhací bombardér, denní a noční stíhač pro každé počasí a jako bitevní a průzkumný letoun. Byl dodáván a používán několika státy během druhé světové války a sloužil ještě mnoho let po ní. Bf 109 byl nepoččetně vyráběným stíhacím letounem v historii a celkem bylo vyrobeno 33.984 letounů od roku 1936 až do dubna 1945.

Na Bf 109 létali tři největší stíhací esa druhé světové války, kteří dosáhli 928 vítězství především na východní frontě. Na Bf 109 létal také Hans-Joachim Marseille, což je největší německé eso v severoafrickém tažení. Léтали na něm také někteří další esa spojenců Německa např. Fin Ilmari Juutilainen s 58 vítězstvími, piloti z Itálie, Rumunska, Chorvatska, Bulharska, Slovenska a Maďarska. Díky neustálému vývoji Bf 109 dokázal držet krok s nejnovějšími spojeneckými stíhacími letouny až do konce II. světové války.

Symbols/Symboly

Drill hole



Vyvrát

Cyanoacrylate



Vteřinové lepidlo

Remove



Odstranit

Reduce



Zbrousit

Make new



Vyrobít

Option



Volba

Bend



Ohnout

Putty



Tmel

Colour name	Humbrol	Colour name	Humbrol
A RLM 22 Black	H33	G Aluminium	H56
B RLM 21 White	H34	H RAL 01 Silver	H11
C RLM 66 Black Grey	H67	I RLM 24 Blue	H25
D Gunmetal	H53	J RLM 23 Red	H60
E RLM 70 BlackGreen	H241	K RLM 02 Grey	H240
F RLM 04 Yellow	H24	L RLM 26 Brown	H113

Drawings/Výkresy:

The last of the Eagles/J.R.Beaman JR.
Modelář 2/2006

References/Podklady

Bf 109 in action part.2
Bf 109G/K Kagero
Aero detail 5 Bf 109G
Suomen Ilmailuhistoriallinen Lehti
Jagdwaflle Bf 109
Internet

Read before you start:

- 1/ Before you begin, study carefully instructions, exploded drawings and numbering of parts.
- 2/ Prior your assembly, choose carefully your variant and remove all parts of it.
- 3/ Optional parts and their application compare with the picture on the box.
- 4/ Carefully remove parts, clean its and prior to applying adhesive, check to see whether the parts fit together.
- 5/ Assemble thoroughly, do not hurry. You will find that your finished model will reflect your time, work and patience.

Doporučení a upozornění:

- 1/ Dříve než začnete ,prostudujte stavební návod a číslování dílů.
- 2/ Před začátkem stavby zvolte verzi a pečlivě vyberte díly pro variantu, kterou chcete stavět .
- 3/ Volitelné díly/možnosti a jejich použití při stavbě konfrontujte s náhledem markingu na obalu.
- 4/ Díly opatrně oddělte z rámečků, odstraňte technologické vtoky a před slepením je řádně začistěte.
- 5/ Pracujte pečlivě, nespěchejte, dokonalý vzhled modelu záleží jen na Vás.

Plastic parts/Plastikové díly

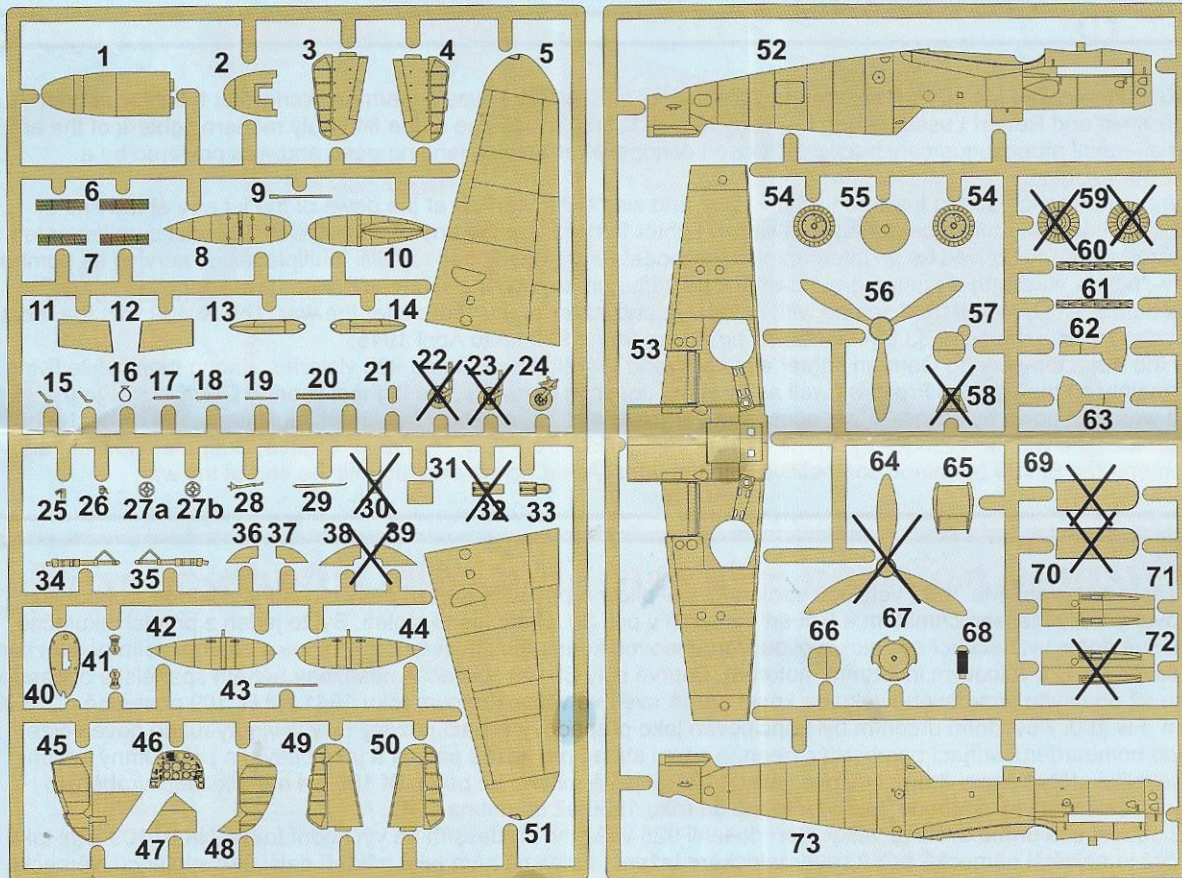

Clear parts/ Pruhledné díly

Standard canopy for/
Standartní kabina pro
Bf 109 G-6, G-6 Trop



Standard canopy for/
Standartní kabina pro
Bf 109 G-6 Erla



2 Port side console
Levá strana

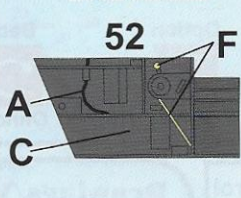

Stanboard side console
Pravá strana

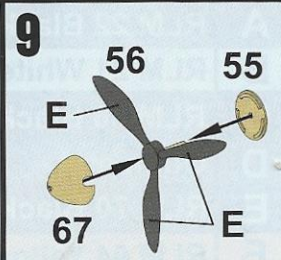
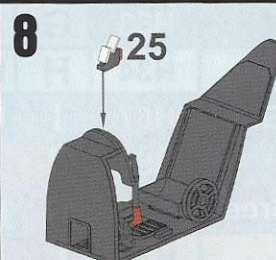
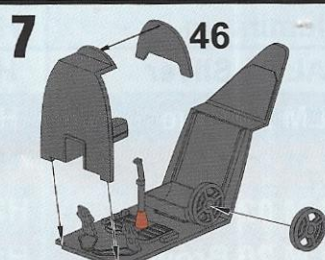
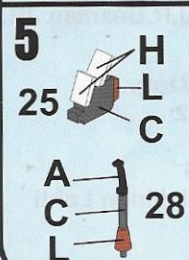
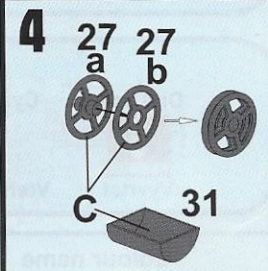
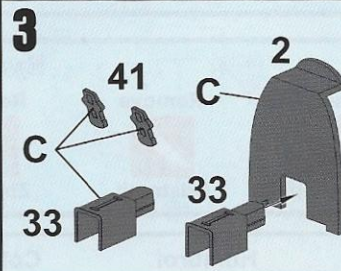
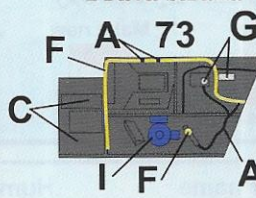

10

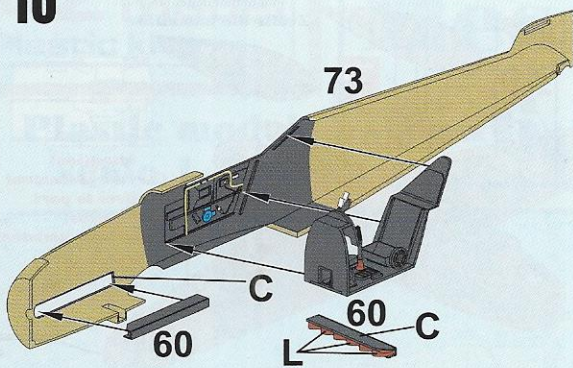

11

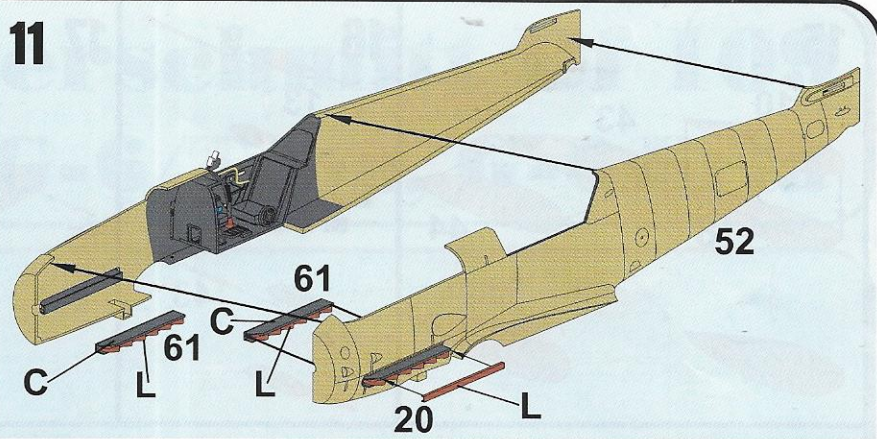

12

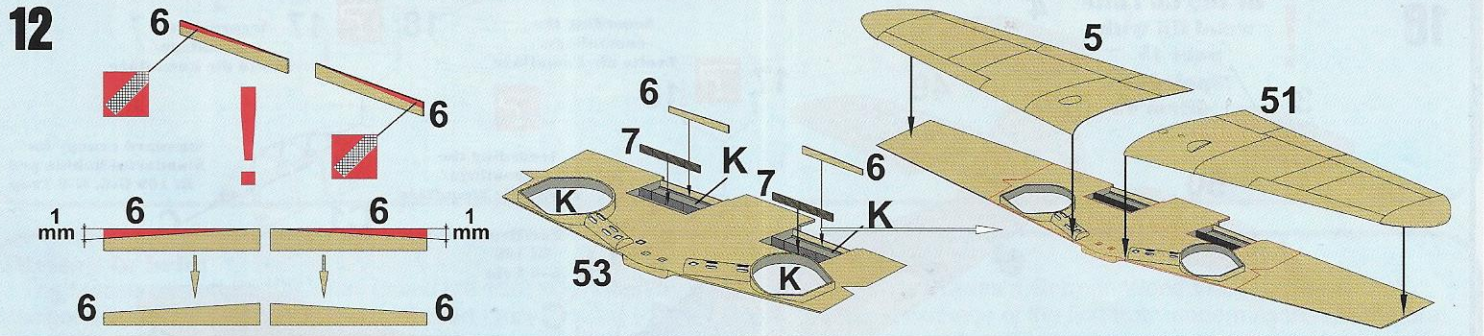

13

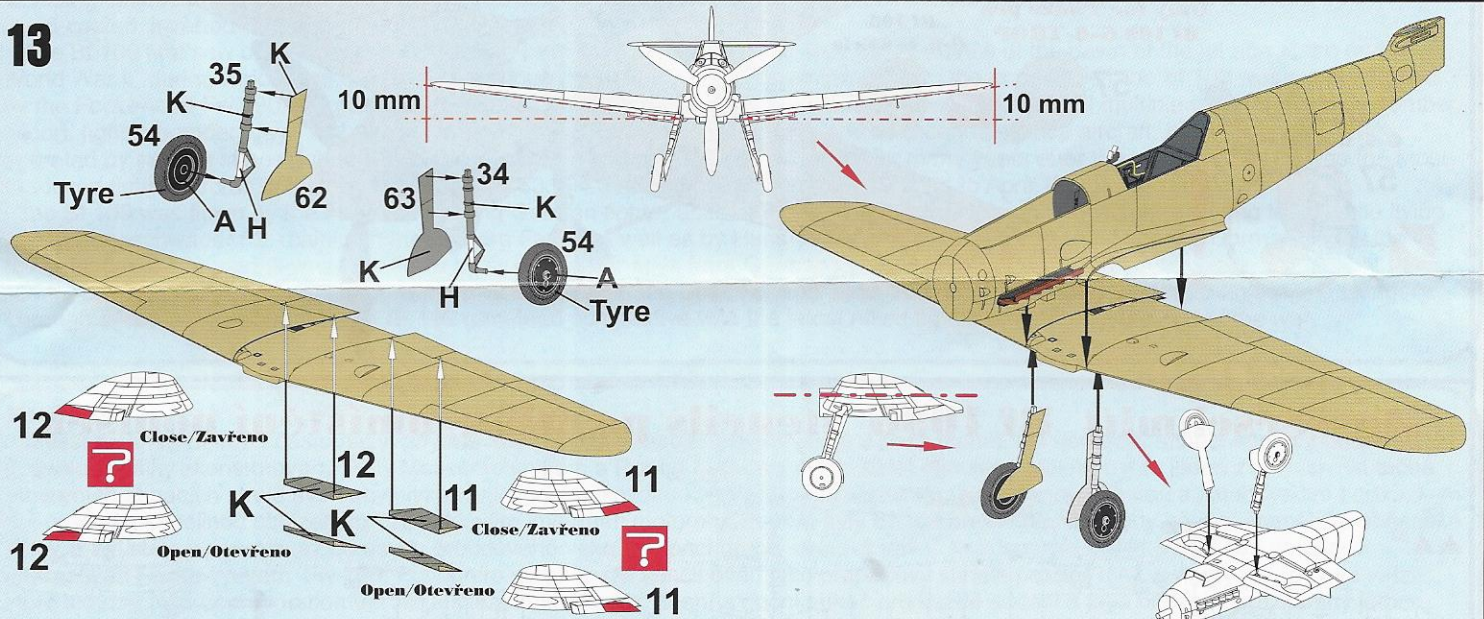

14

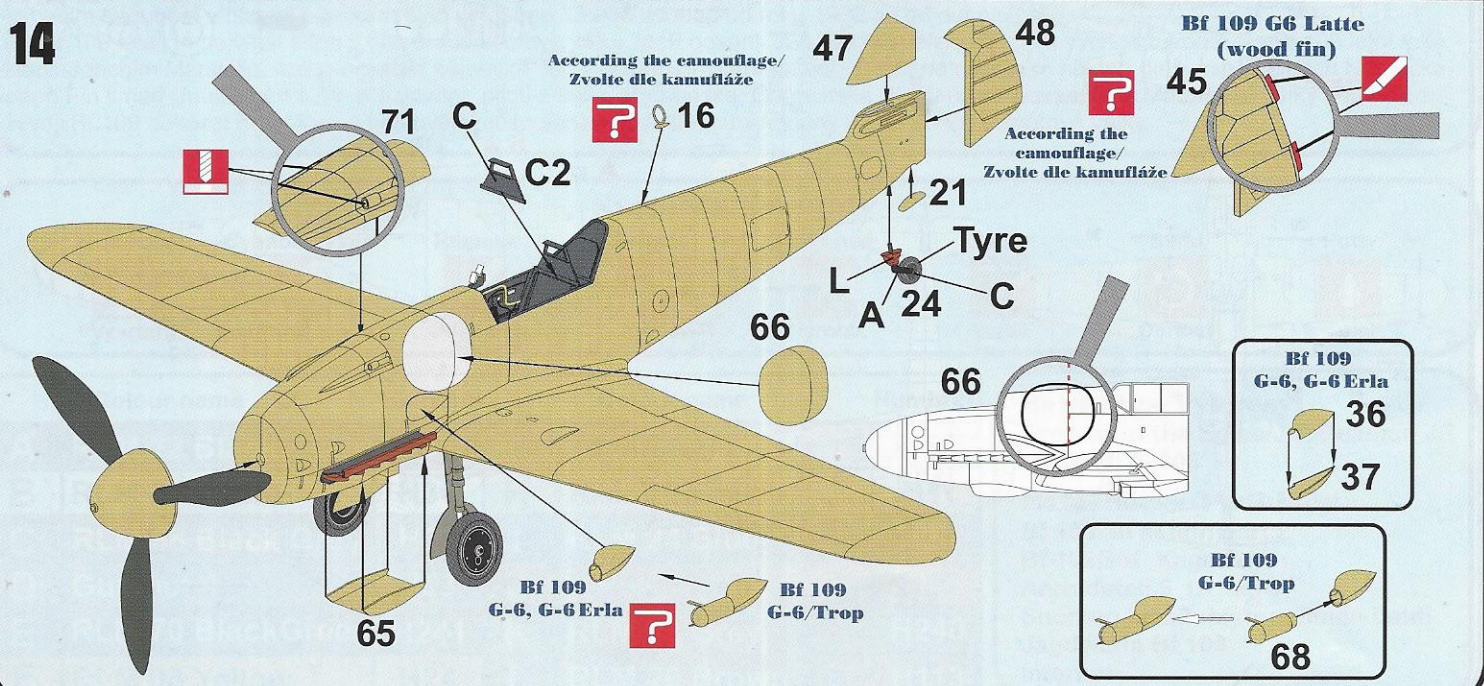

15

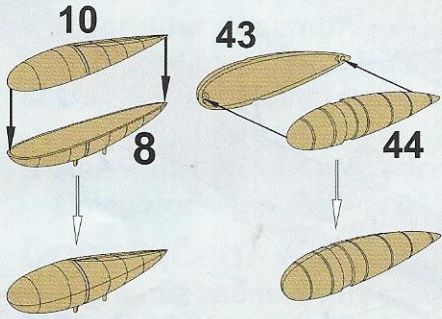

16



Only for/Pouze pro Bf 109 G-6/R-6

17

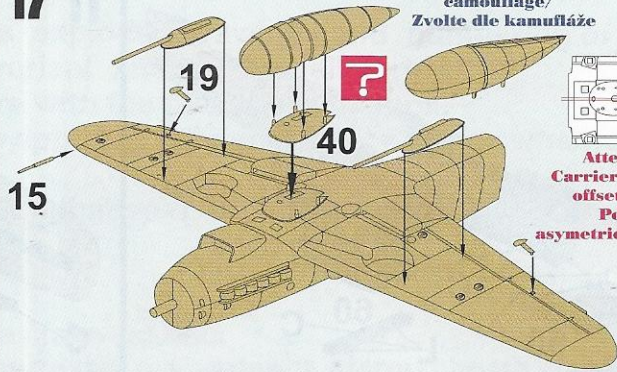

According the camouflage/
Zvolte dle kamufláže

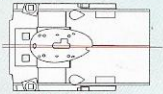

Attention!
Carrier placement
offset to port
Pozor!
asymetrické umístění

18

Bf 109 G6
wood fin with
part 45
Společně s
dílem 45

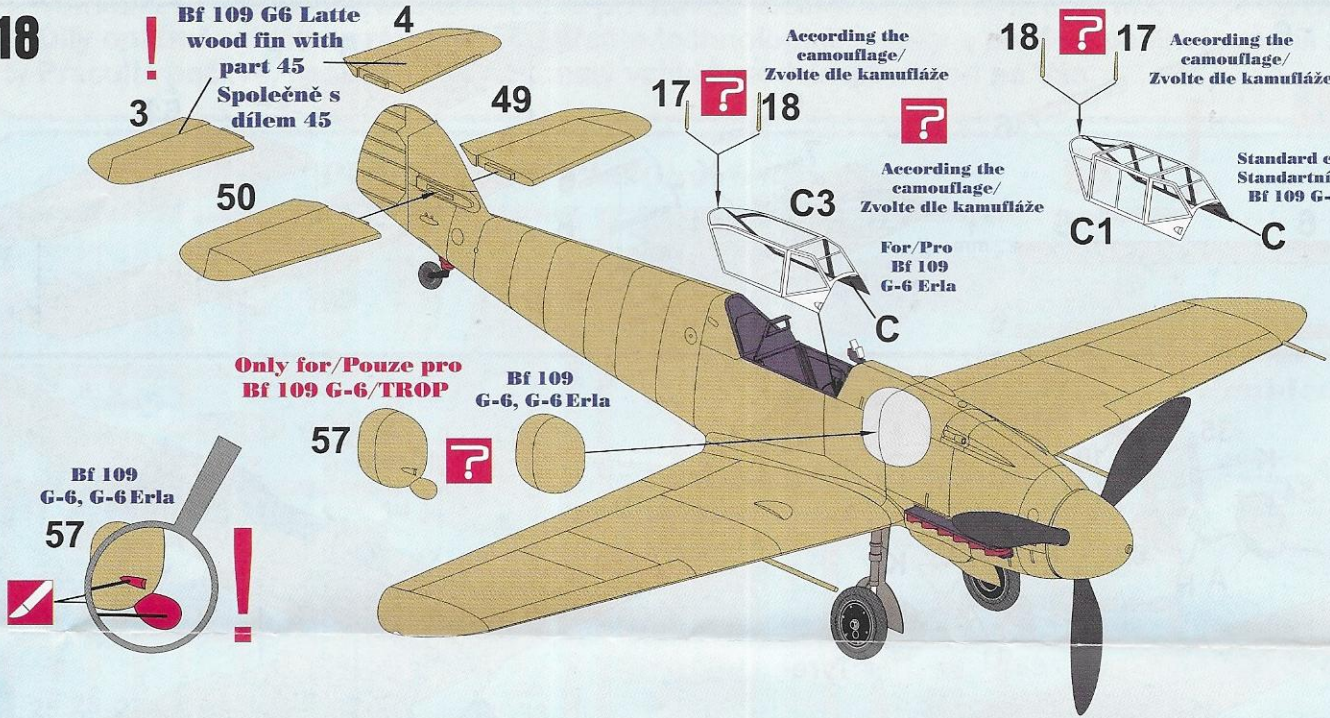

According the camouflage/
Zvolte dle kamufláže

18

17

According the camouflage/
Zvolte dle kamufláže

According the camouflage/
Zvolte dle kamufláže

For/Pro
Bf 109
G-6 Erla

Standard canopy for/
Standardní kabina pro
Bf 109 G-6, G-6 Trop

Only for/Pouze pro
Bf 109 G-6/TROP

Bf 109
G-6, G-6 Erla

Bf 109
G-6, G-6 Erla

57



Messerschmitt Bf 109G stencils position/umístění popisek

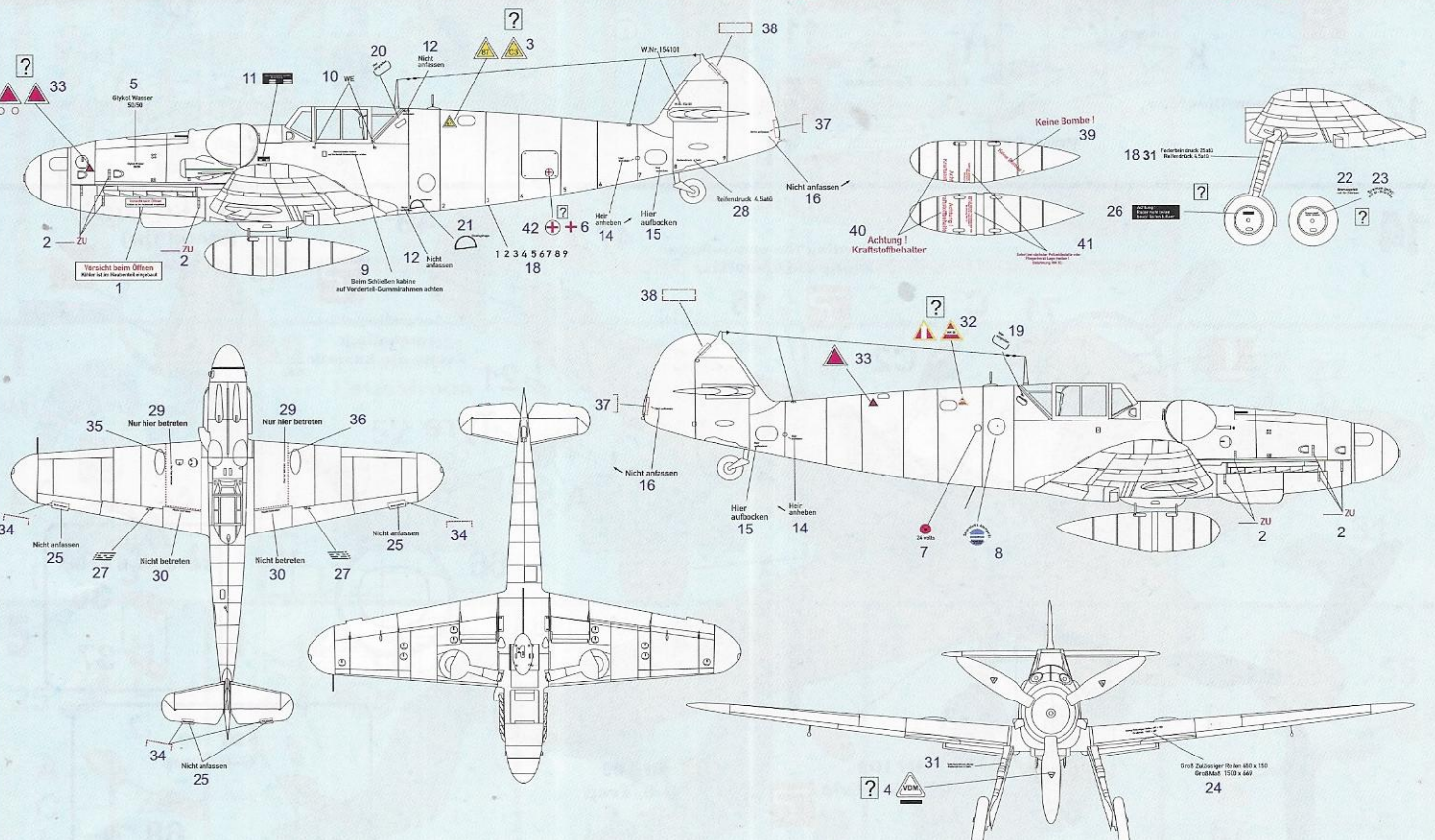

AZmodel
Plastic kits

Famous German Fighter

Messerschmitt

Bf 109G-6

“Jagdgeschwader JG.53”

1/72

Scale model kit

スケールモデルキット

Limited edition.

- ① Messerschmitt Bf 109G-6, W Nr. 18107,
white 9+1, 7/JG 53, flown by Uffz. Georg Amon,
Sciacca airfield 1943, Sicily, Luftwaffe

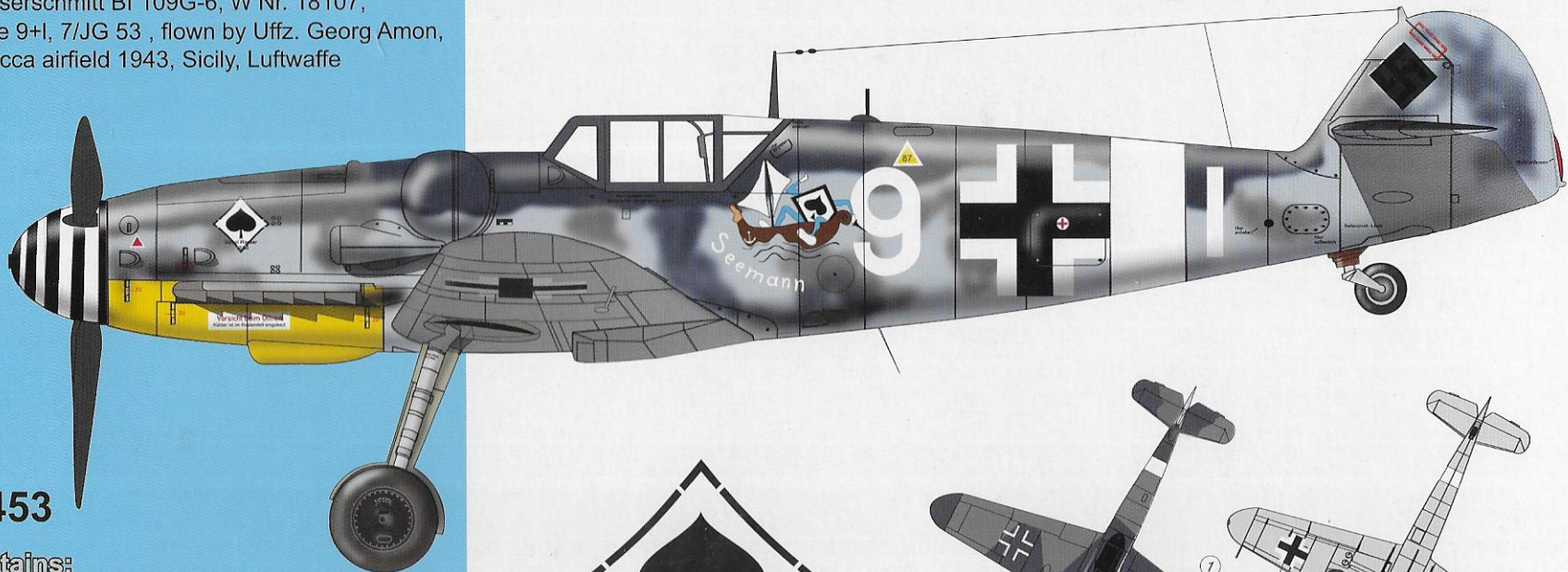

AZ 7453

Box contains:

- plastic parts
- decal sheet for 4 versions
- full colour instructions

UNASSEMBLED MODEL KIT. CEMENT AND PAINT NOT INCLUDED.
組み立て式プラスチックモデルキットです。1セット分のプラスチックパーツが入っています。
接着剤と塗料はこのキットに含まれておりません。別途お買い求め下さい。

2

Messerschmitt Bf 109G-6, W Nr. unknown, white 5+1, 7/JG 53, Sciacca airfield, Sicily, Luftwaffe

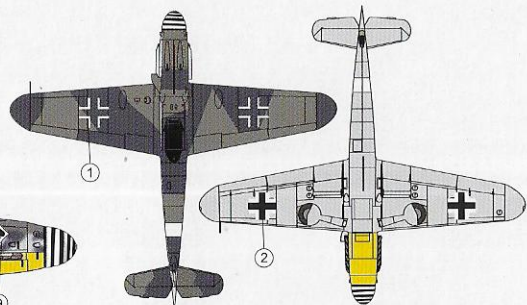
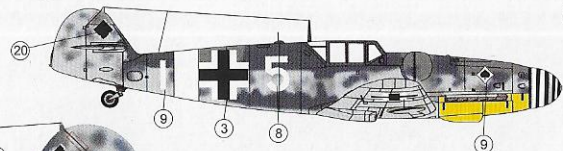
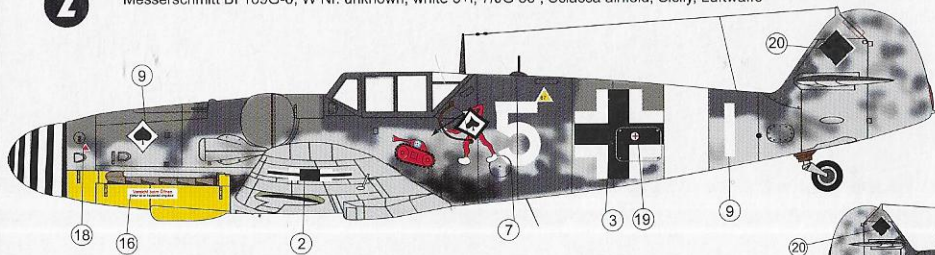
**3**

Messerschmitt Bf 109G-6, W Nr. unknown, white 6+1, flown by Uffz. Georg Amon, Sciacca airfield 1943, Sicily, Luftwaffe

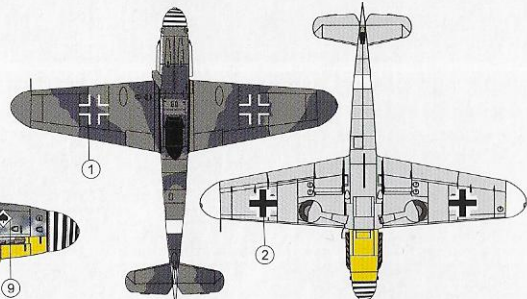
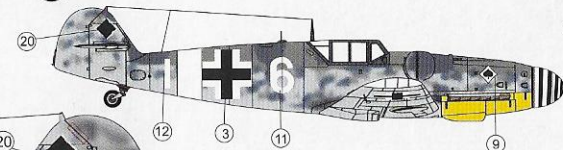
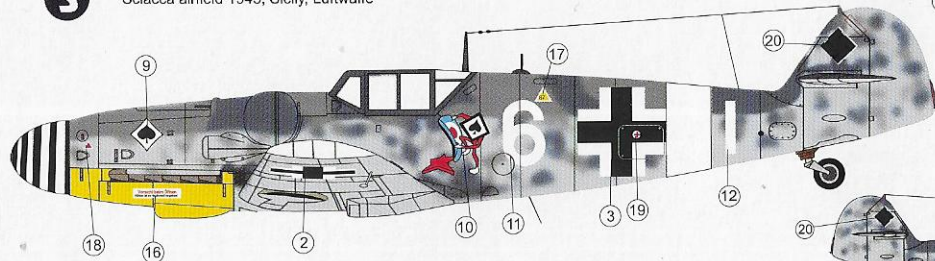
**4**

Messerschmitt Bf 109G-6/R6, W Nr. unknown, yellow 3+1, 9/JG 53, flown by Uffz. Heinz Jegg, Grazzanise airfield 1943, Sicily, Luftwaffe

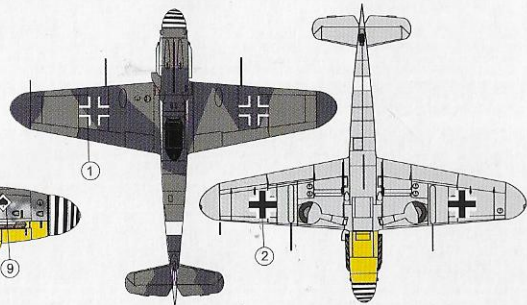
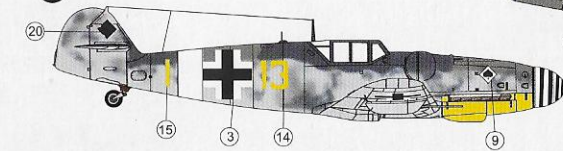
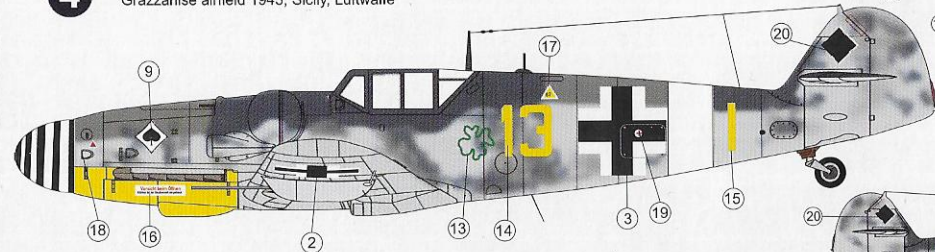

Paint Numbers:
HUMBROL

245DARK
GREY
RLM 74**246**GREY
VIOLET
RLM 75**247**LIGHT
BLUE GREY
RLM 76**24**YELLOW
RLM 04**34**

WHITE

33

BLACK

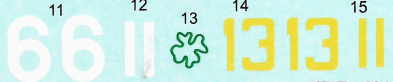
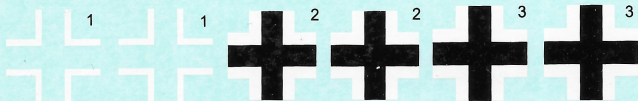

printed by Eduard



BF 109G-6 JG 53 AZ 7453

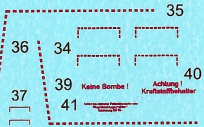

design
H-Markets

AZmodel BF 109G Stencils

Keine Bombe!
Achtung!
Kraftstoffbehälter