

eduard
MASK

B-24J Liberator 1/48

The die-cut mask for accurate canopy frame painting of the
Monogram scale 1/48 KIT

EX 136

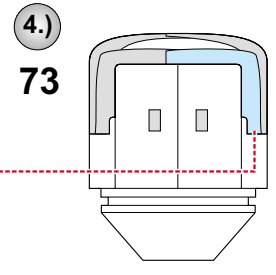
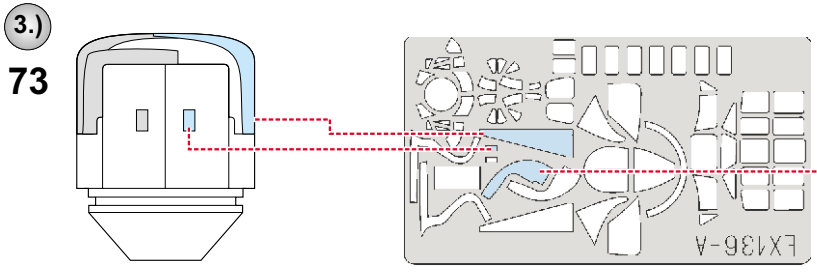
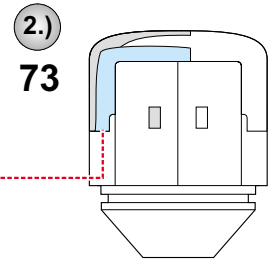
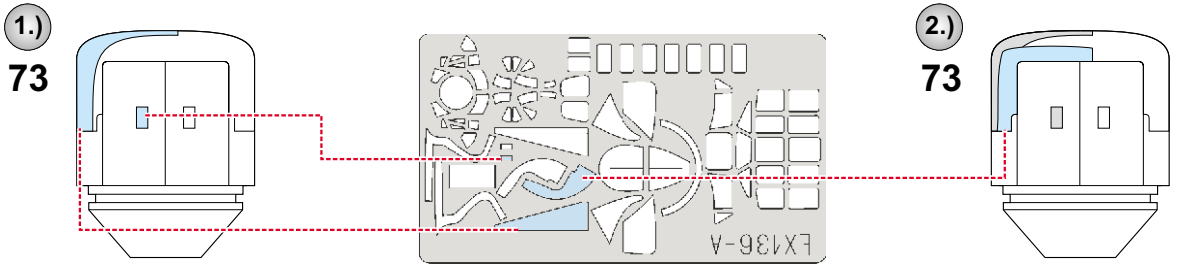
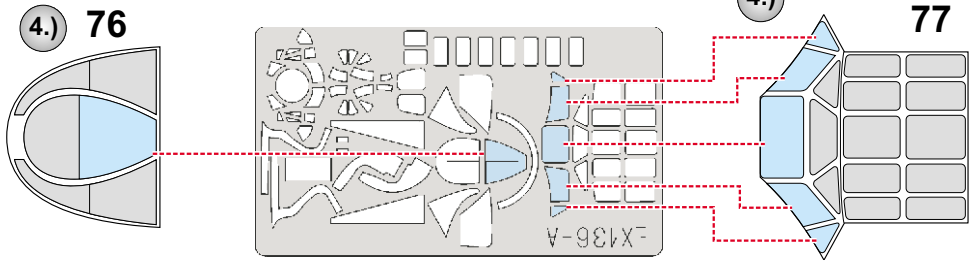
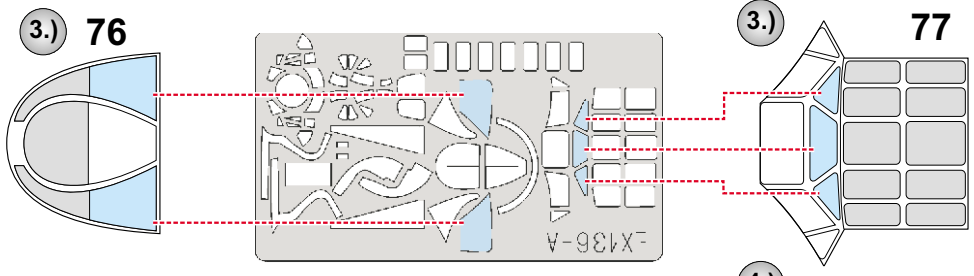
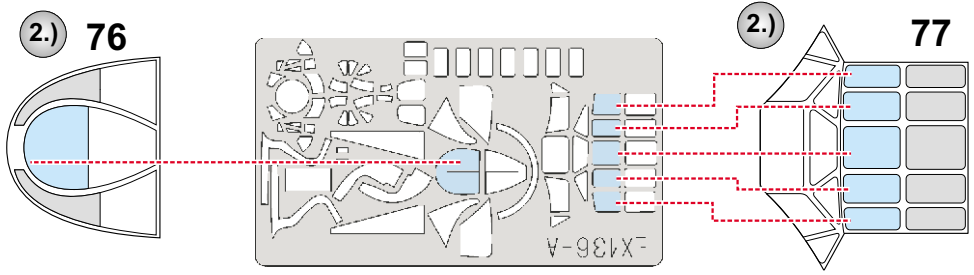
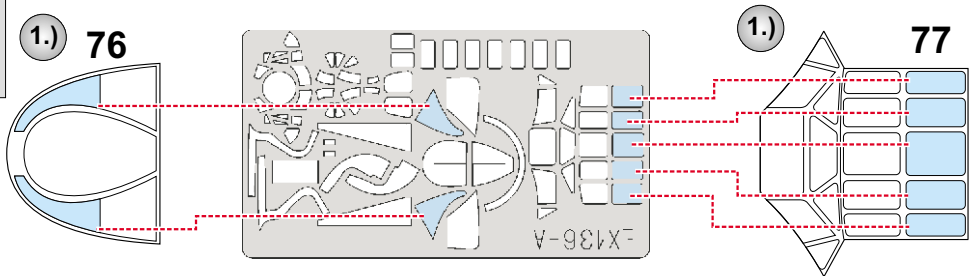
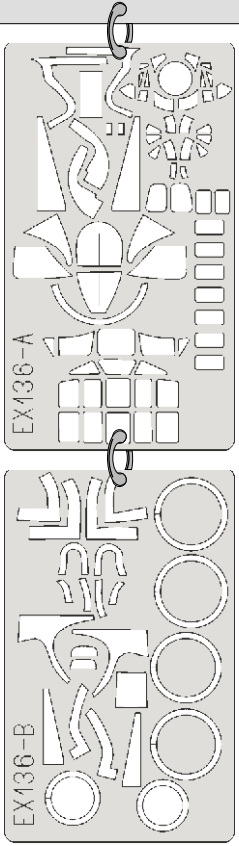

5.)

73

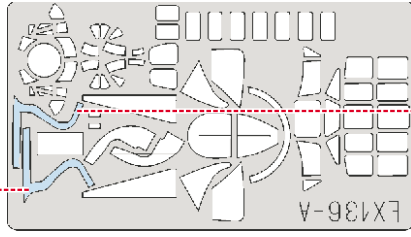
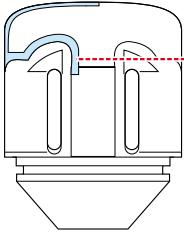

6.)

73

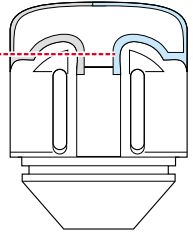

7.)

73

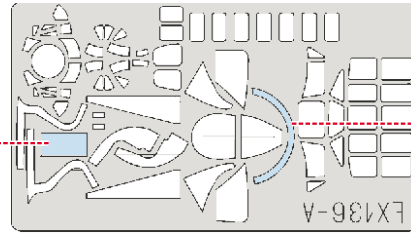
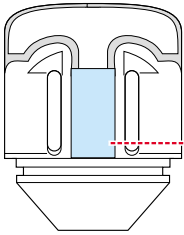

74

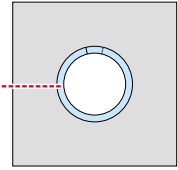

1.) 81

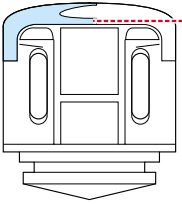

2.) 81

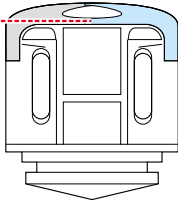

3.) 81

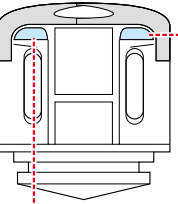

5.) 81

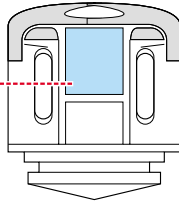

5.)

81

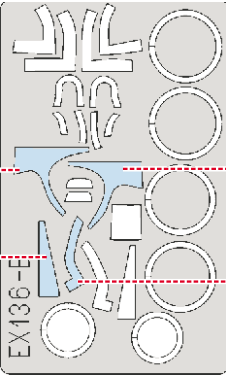
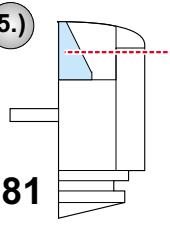

6.)

81

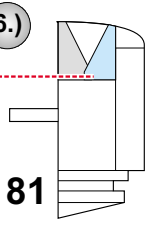

7.)

81

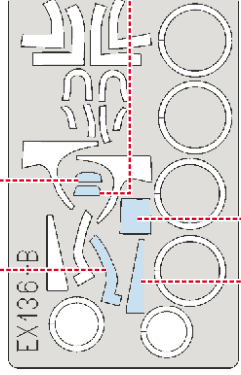
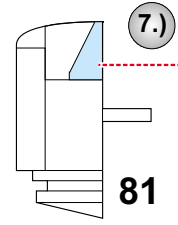

8.)

81

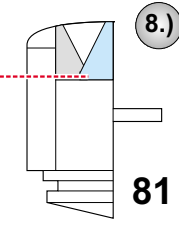

1.)

80F

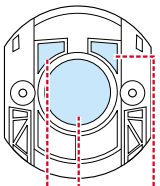

2.)

80F

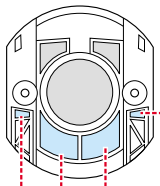

3.)

80F

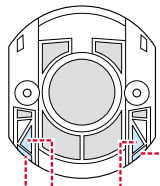

4.)

80F

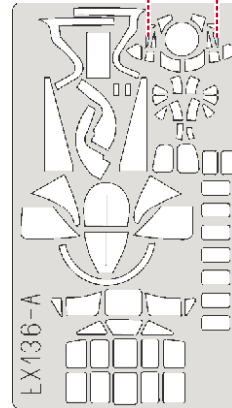
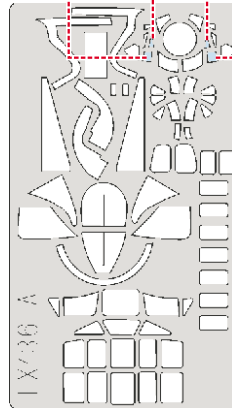
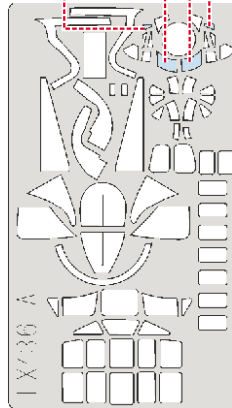
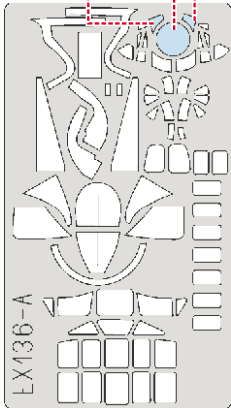
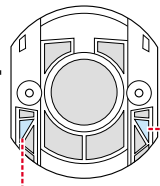

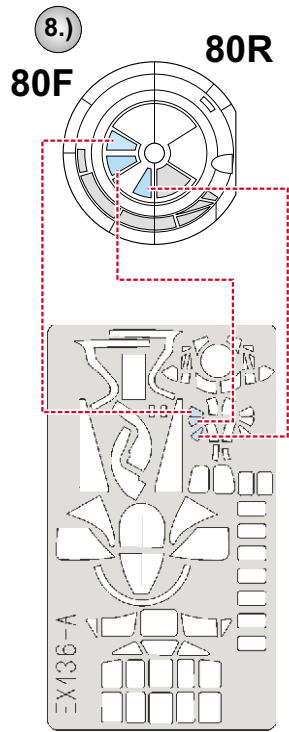
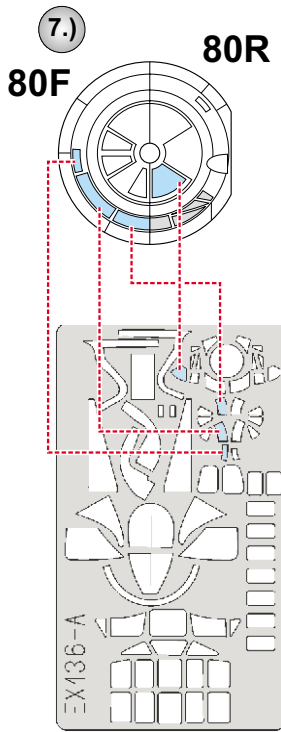
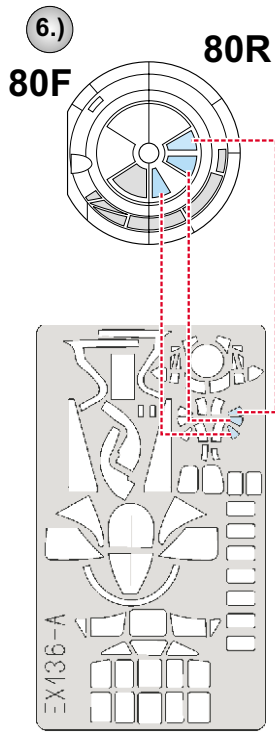
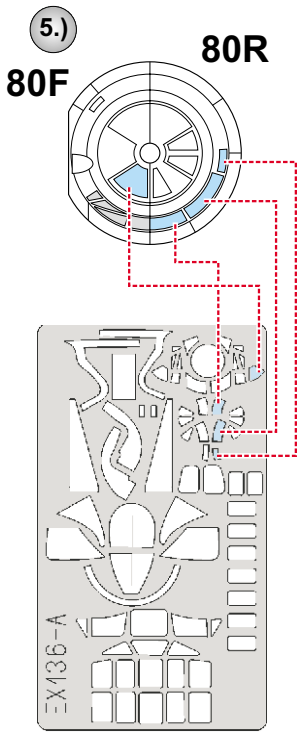

INTERIOR COLOR

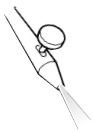

LIQUID MASK

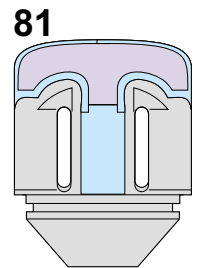
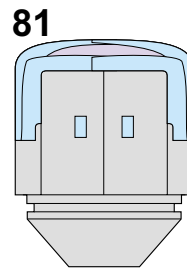
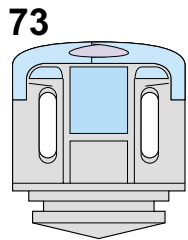
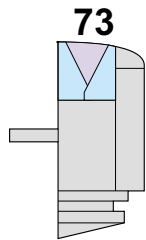
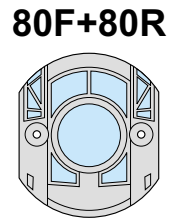
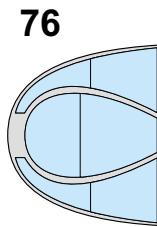
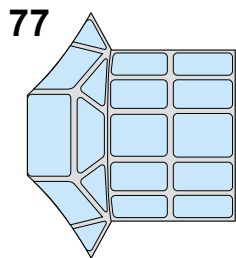

CAMOUFLAGE COLOR

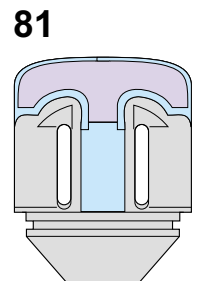
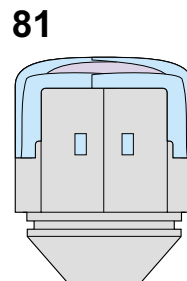
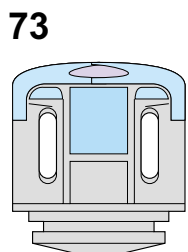
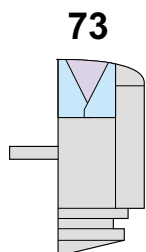
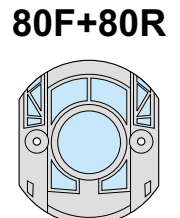
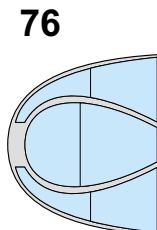
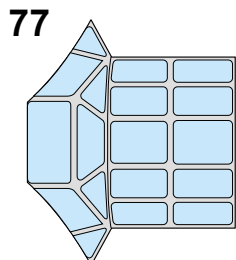
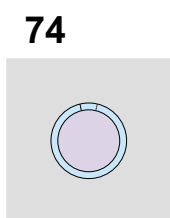

1.) 79

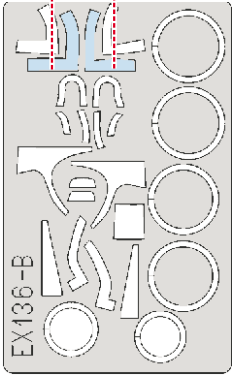
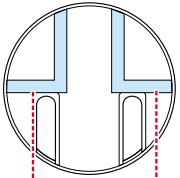

2.) 79

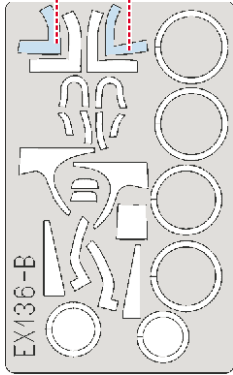
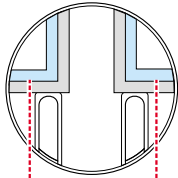

3.) INTERIOR COLOR

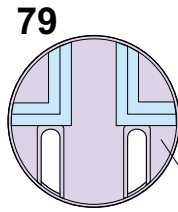

LIQUID MASK

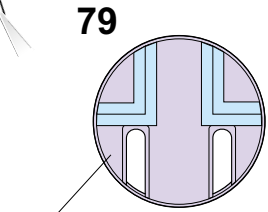

5.) REMOVE MASK

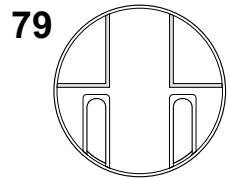

6.) 79

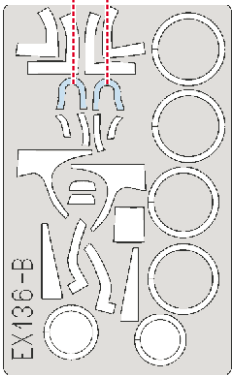
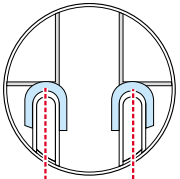

7.) 79

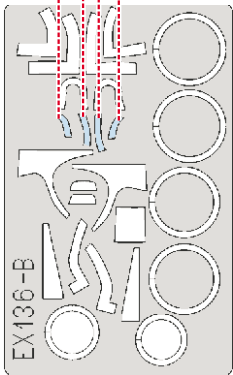
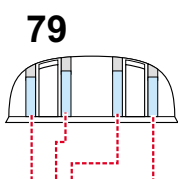

8.) INTERIOR COLOR

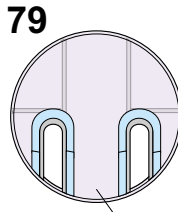

LIQUID MASK

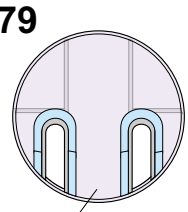

10.) REMOVE MASK

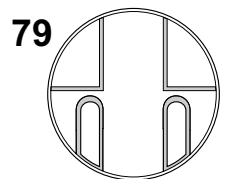

58R

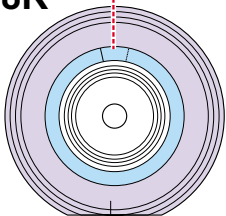

LIQUID MASK

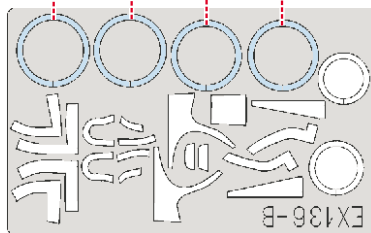

58L

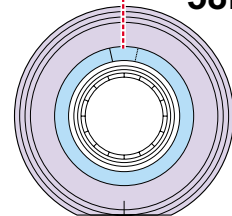

LIQUID MASK

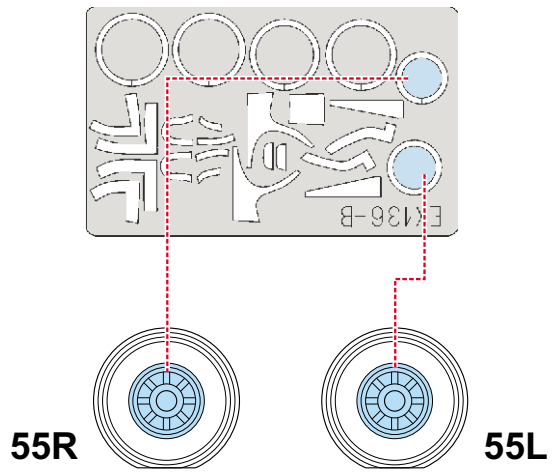
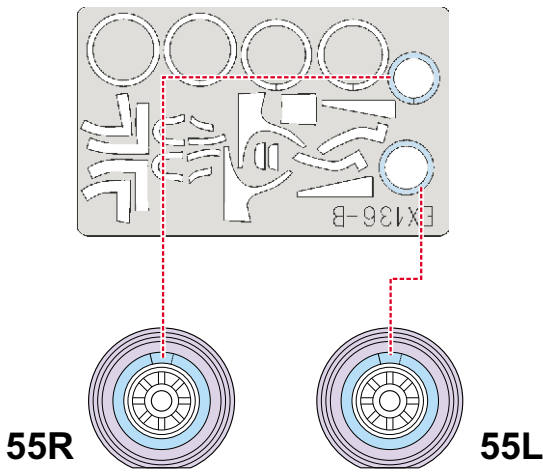

LIQUID MASK

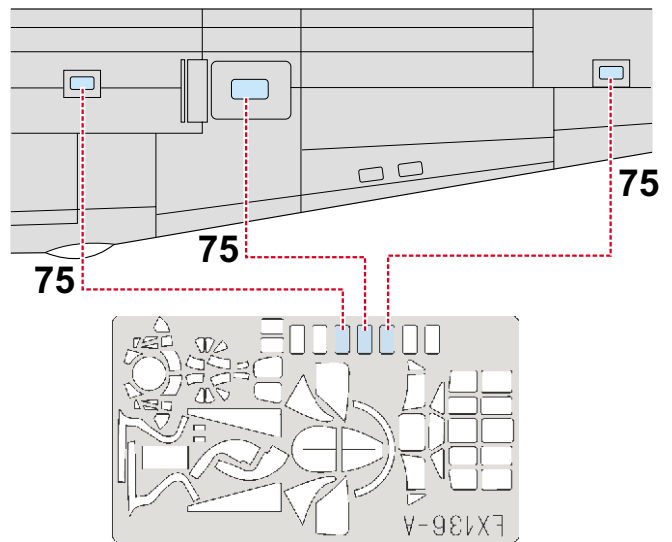
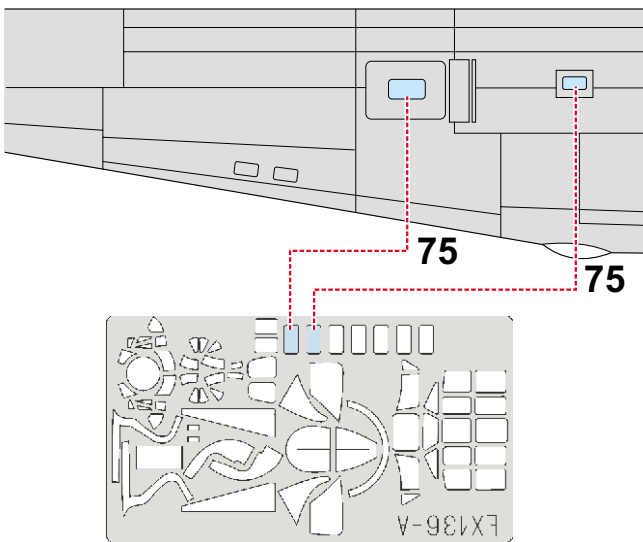
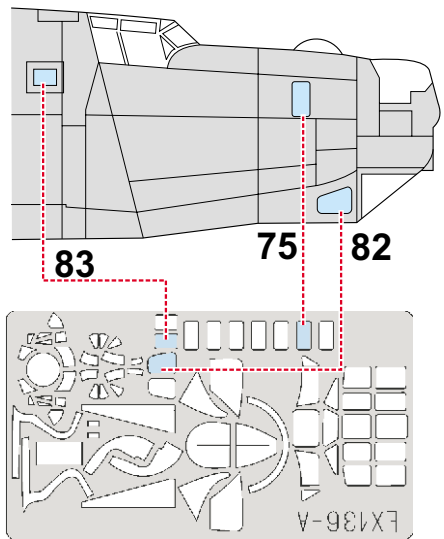
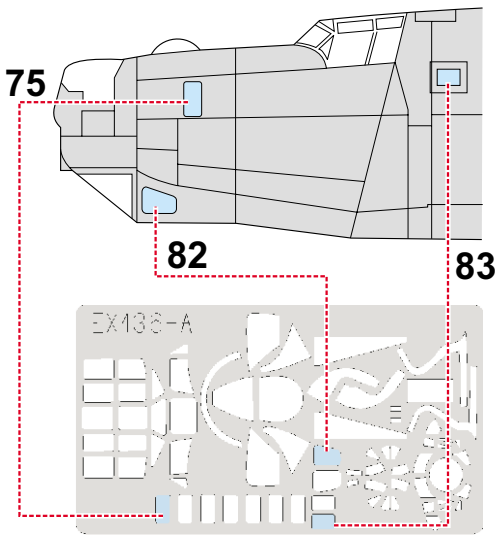

REFERENCES: Squadron/Signal Publ.:In Detail # 8264 - B 24 Liberador
Special MACH 1 - B-24 Liberador