

1944-45.

- ① Spitfire XVI TB900/GE-D of Sqn Ldr R A Lallemand, No 349 (Belgian) Sqn, B106 Twente, Holland, and B113 Varrelbusch, Germany, April-May 1945

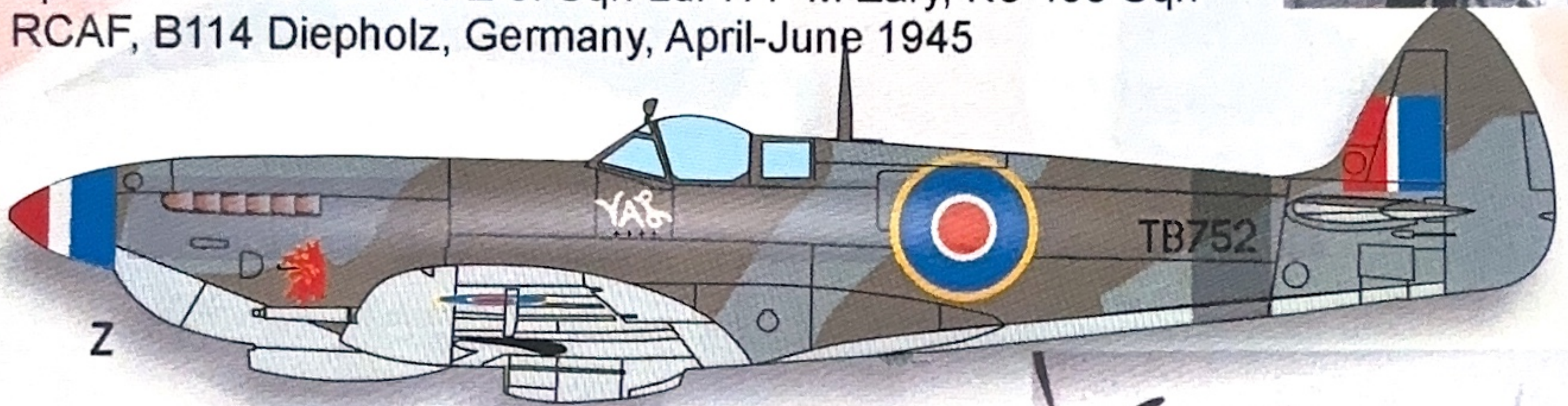

- ② Spitfire XVI TB752/KH-Z of Sqn Ldr H P M Zary, No 403 Sqn RCAF, B114 Diepholz, Germany, April-June 1945



- ③ Spitfire XVI TD 246/ GRM of Gp Capt G R McGregor, No 126 Wing, B116 Wunstorf and B152 Fassburg, Germany, July-August 1945



- ④ Spitfire XVI TB 476/2I-D of Sqn Ldr A H Sager, No 433 Sqn RCAF, B90 Kleine Brogel Belgium, March 1945



- ⑤ Spitfire XVI TD 324/SS of Wg Cdr R W F Sampson, No 145 (French) Wing, B85 Schindel, Holland, April-May 1945

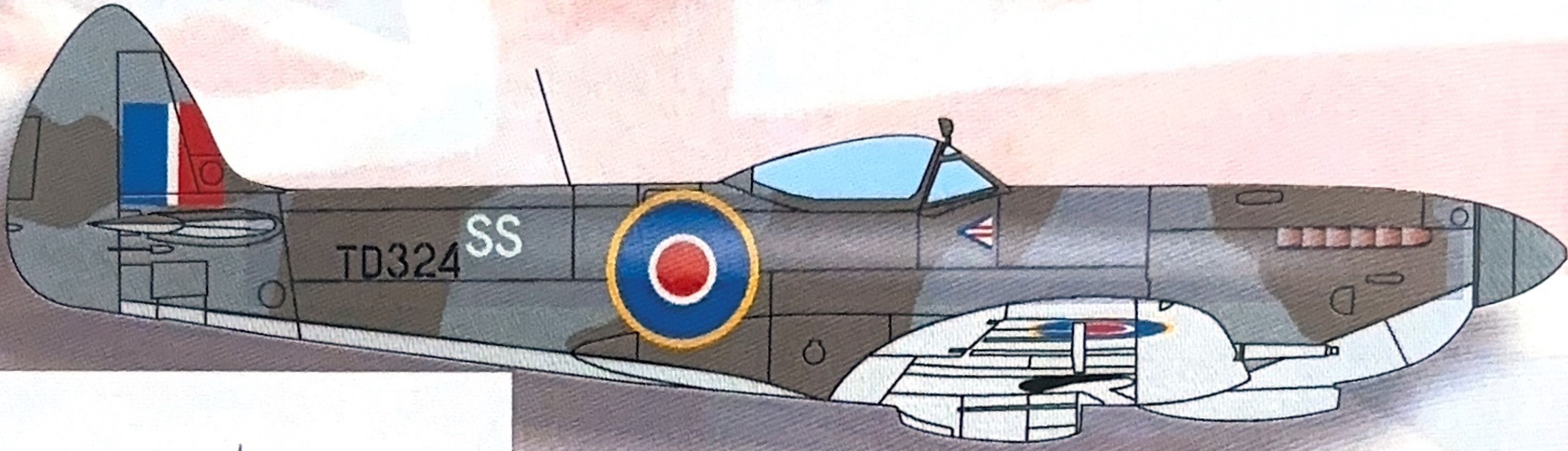

- ⑥ Spitfire XVI TB 756/DN-H of Flt Lt J D Lindsay, No 416 Sqn RCAF, B114 Diepholz and B154 Reinsehlen, Germany, 24-28 April 1945

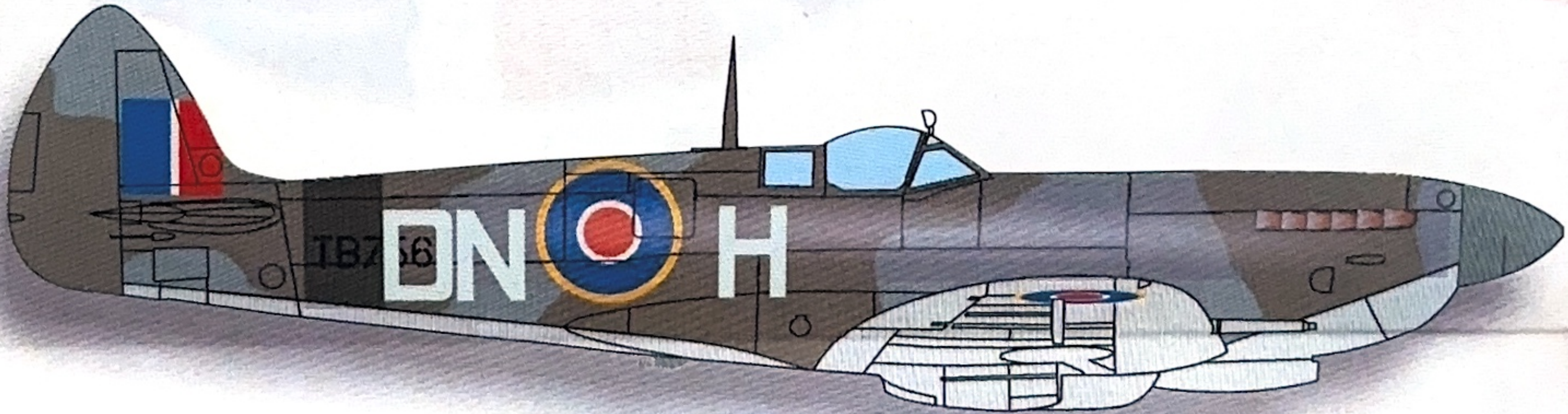

- ⑦ Spitfire XVI TD 126/AU-C of Sqn Ldr J D Browne, No 421 Sqn RCAF, B90 Kleine Brogel, Belgium, March 1945

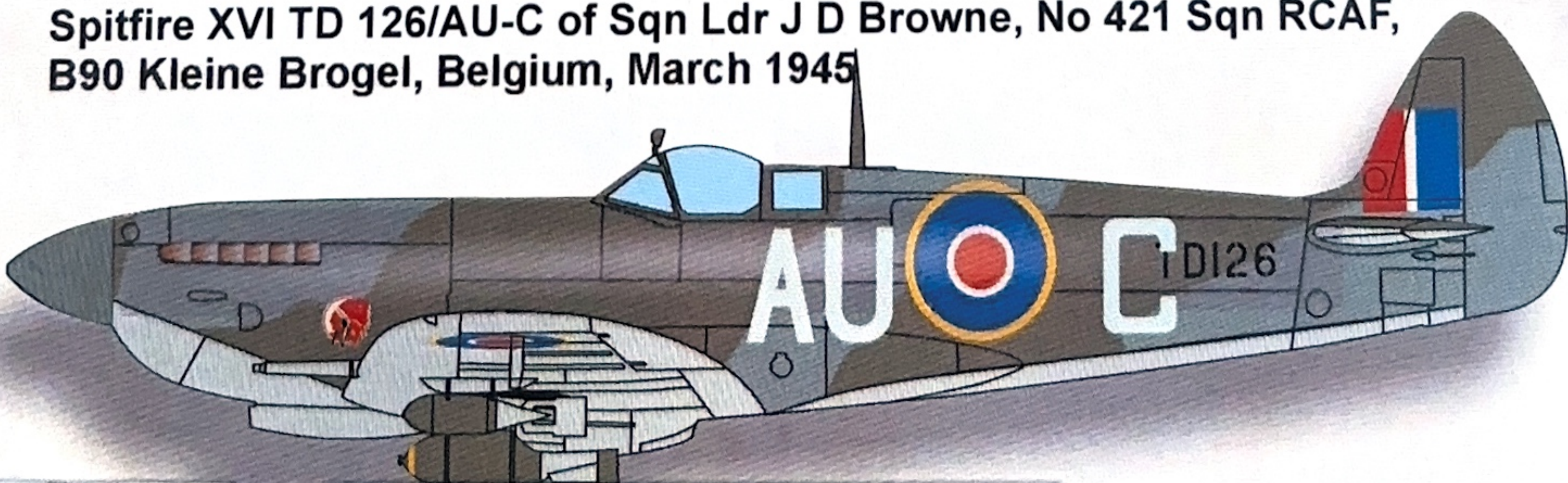

- ⑧ Spitfire VII MD 120/NX-O of Sqn J J O'Meara, No 131 Sqn, Culmhead, March-June 1944

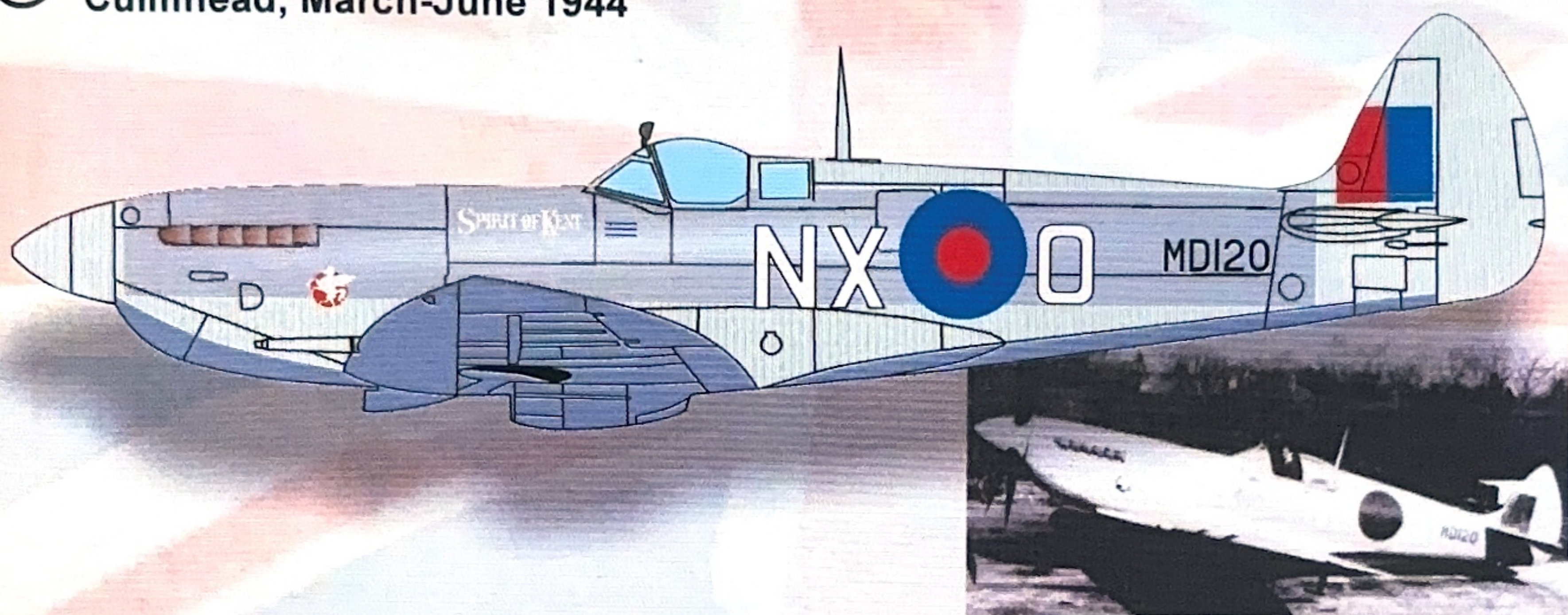

- ⑨ Spitfire VII EN 509/ON-G of Flt Lt W J Hibbert, No 124 Sqn, Bradwell Bay, 31 May 1944

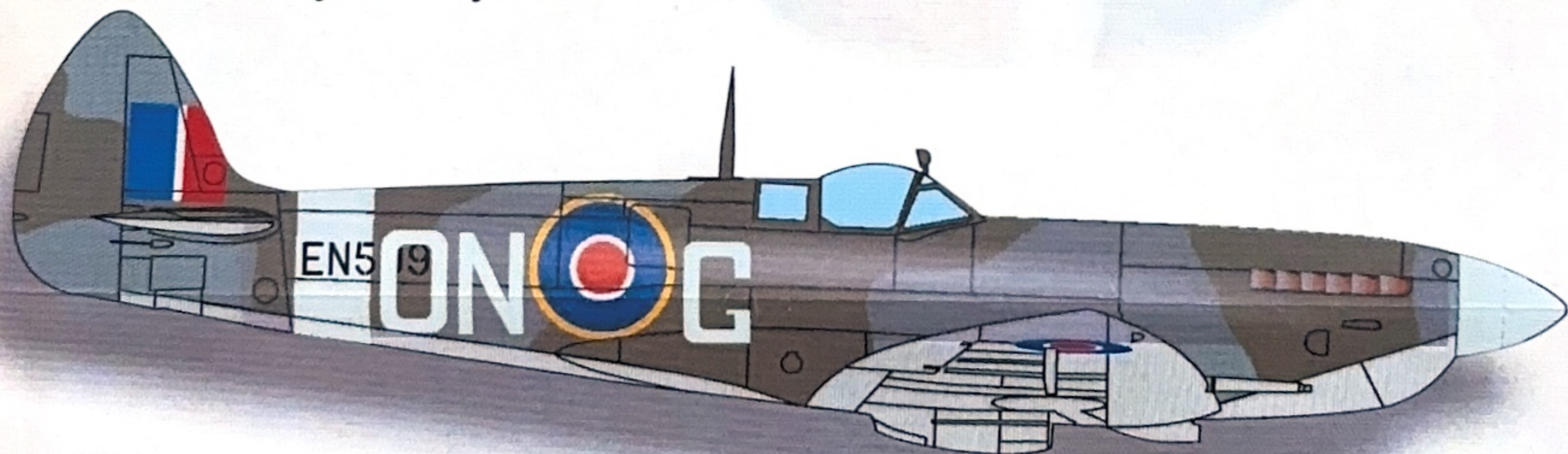

- ⑩ Spitfire VII MD 182/YQ-E of Flt Lt G A Harrison, No 616 'South Yorkshire' Sqn, Culmhead, 4 June 1944

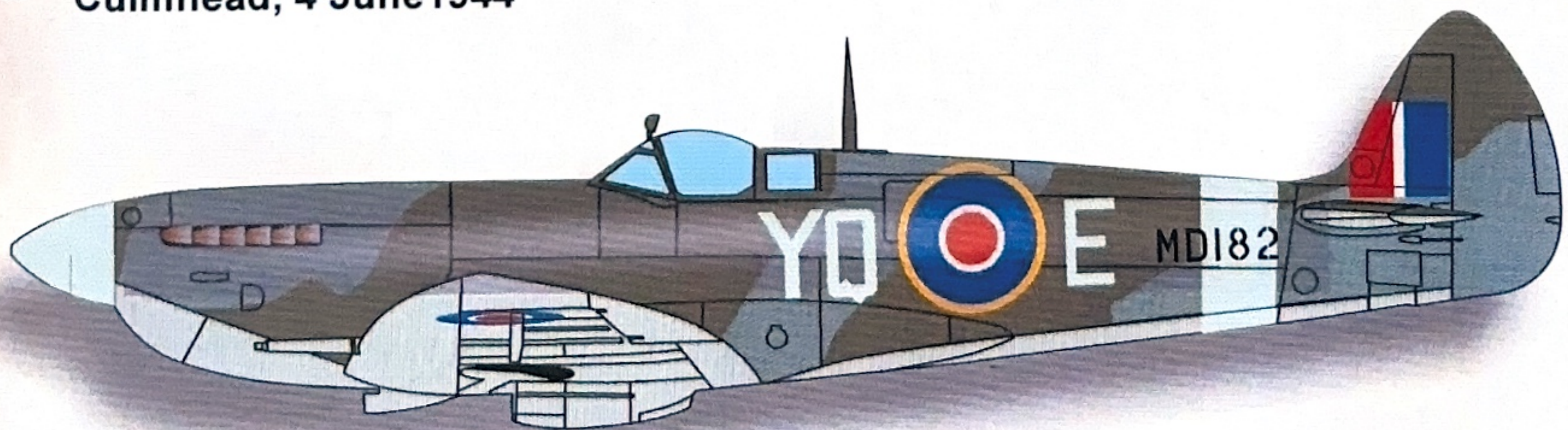

Technical stencils

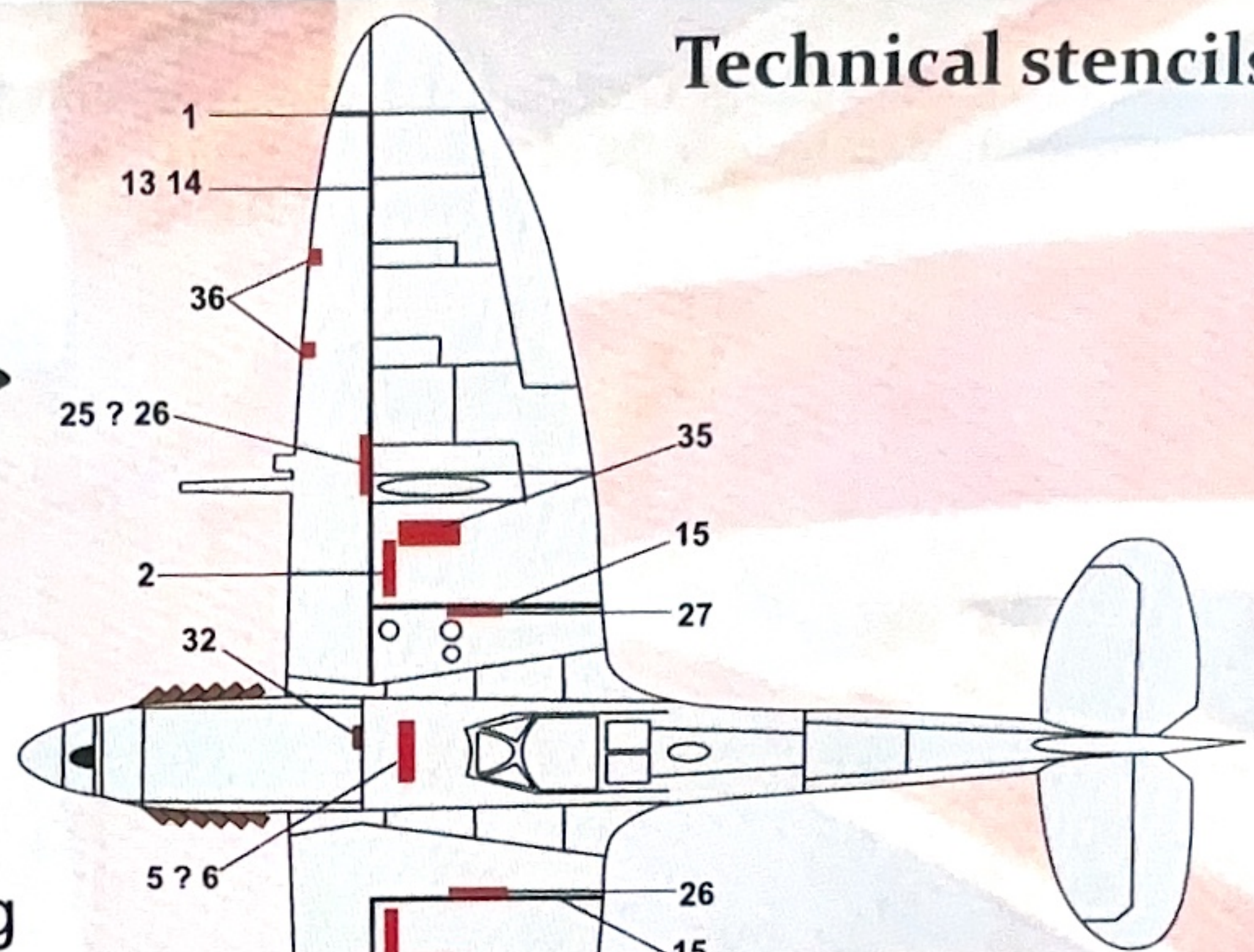
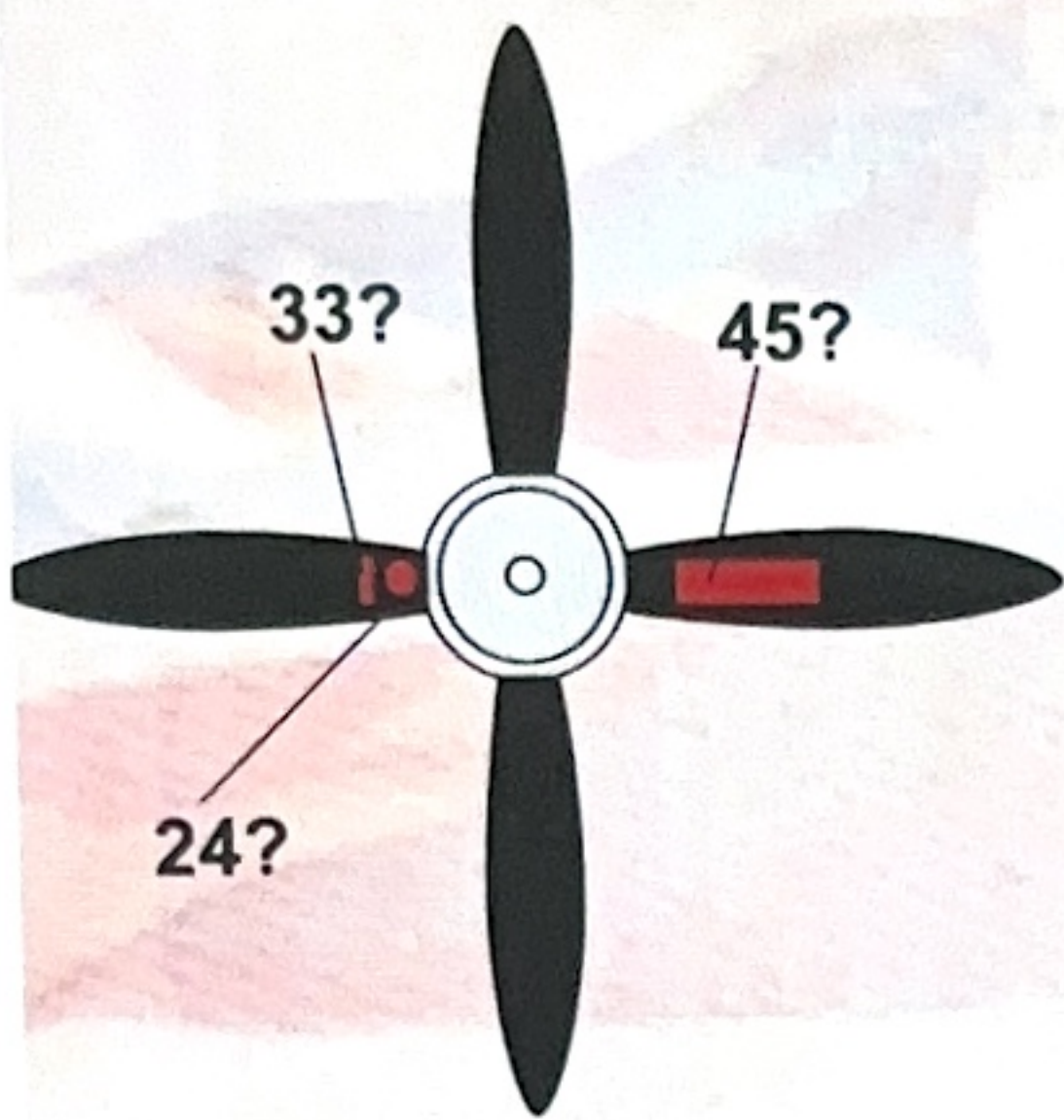

www.printscale.org

