

# PANTHER A

w/zimmer  
& FULL INTERIOR

全内構黑豹A坦克

1/48 SCALE

NO 003



JASON 2021

優速達

SUYATA



## Caution / 注意 / 警告

1. Don't swallow any items in the package.  
部品を誤って飲み込まないようにご注意ください。  
讀物や食產品包装中の物品。
2. Don't put the package into your mouth, nose or on your head.  
ポリ袋を頭から被らないでください。窒息するおそれがあります。  
讀物將袋を首に巻かず、首を覆わないでください。
3. Keep this product away from fire or high temperature source.  
本製品を火気や熱源の近くには置かないでください。  
讀物將本產品置于明火或者高温源附近。

## Please pay attention before assembly.

製作する前に必ずお読みください。 / 制作前請注意。

1. Read carefully and fully understand the instructions before commencing assembly.  
組立図をよく読み、組立順番に従って組立ててください。  
讀物將詳細讀說明書、并技照說明書標明的步驟進行制作。
2. Check out part numbers before removing parts from sprues.  
部品番号を確認して組立ててください。  
認準零件編號字牌。
3. Confirm the direction and shape of the parts.  
部品の向きや形状にご注意ください。  
認準零件的方向和形状。
4. Some parts are sharp, be careful when assembling.  
鋭い部品があるため、組立にはご注意ください。  
部分零件銳利、組立時請小心。
5. Adhesives can be used to increase firmness during assembly.  
接着剤を使用して組立てることも可能です。  
組立過程中、可使用粘台黏增加牢固。

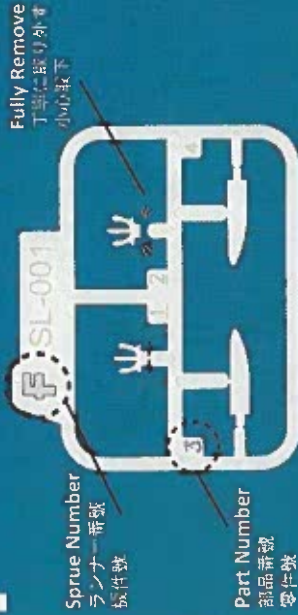

Fully Remove  
丁寧に取り除く  
小心取下

Sprue Number  
ランナー番號  
版件號

Part Number  
部品番號  
零件號

此結構需要切除  
This structure needs to be excised  
切り取ります

## Applying decals / 貼り方/水貼使用方方法

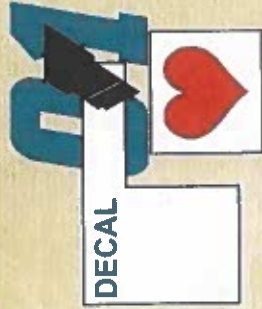

01 Cut out decal design from sheet  
貼りたいマークを切り抜きます  
將水貼剪下

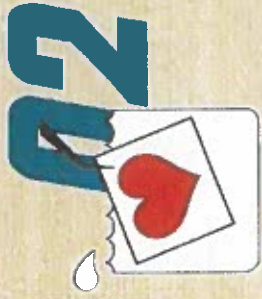

02 Dip the decal in the tepid water  
for 15~20 sec  
マークをぬるま湯に15秒から20秒まで浸します  
將水貼在溫水中浸泡15至20秒

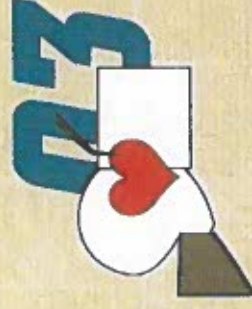

03 Hold the backing sheet edge and  
slide decal onto the model  
マークをスライドさせてモデルに移します  
將水貼從底紙上移至模型



04 Move decal onto position with cotton  
swab, press decal gently down until  
excess water and air bubbles are gone  
綿棒でマークを正しい位置にずらして、  
氣泡や水分をとります  
用棉棒將水貼調整到相應位置、并將水  
份和氣泡擠壓出



1 Sprues are sharp, sides  
are sharp, handle with care  
字牌銳利、  
邊緣銳利、  
請小心



2 Need to use  
adhesive  
請使用粘台  
黏增加牢固



3 The other side  
請注意  
裏面



4 Optional part  
請注意  
非標準零件



5 Decal  
請注意  
水貼



6 Make it sets  
請注意  
零件



7 Assembly  
sequence  
請注意  
組立順序



8 Confirm the direction  
and shape of the parts  
請注意零件的方向和  
形狀



9 Drilling  
請注意  
鑽孔



10 PE parts  
請注意  
PE零件



11 Zimmer's decal  
請注意  
齊默爾水貼



12 Transparent glue  
請注意  
透明膠



Tweezers  
鑷子



Modeler's knife  
筆刀



Cement  
粘台黏



Pliers  
鉗子



Tools  
工具

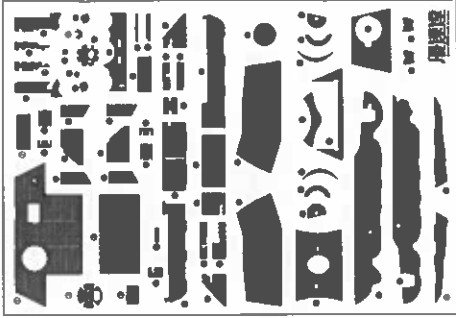

Zimmerit Decal

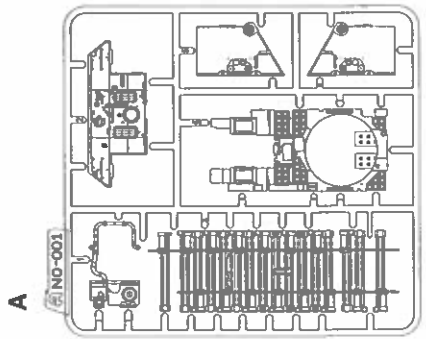
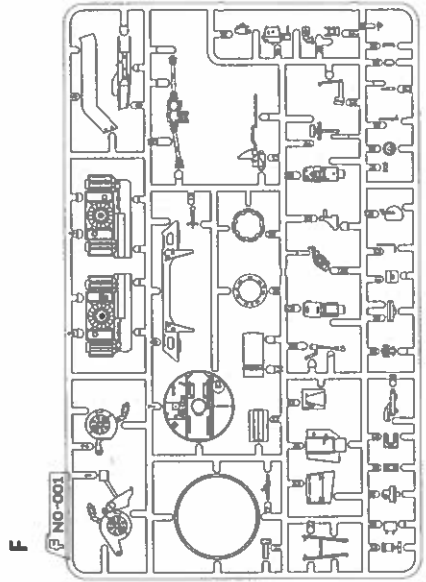
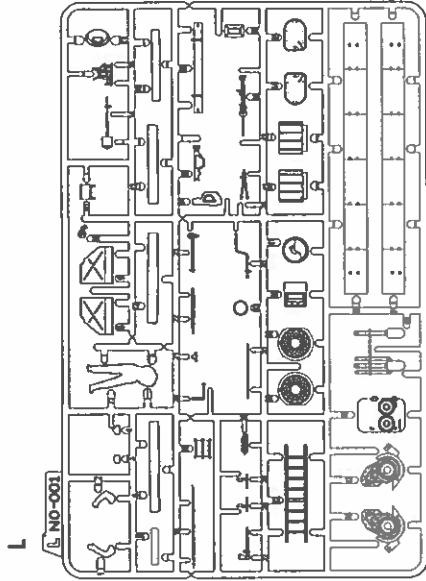

B x2

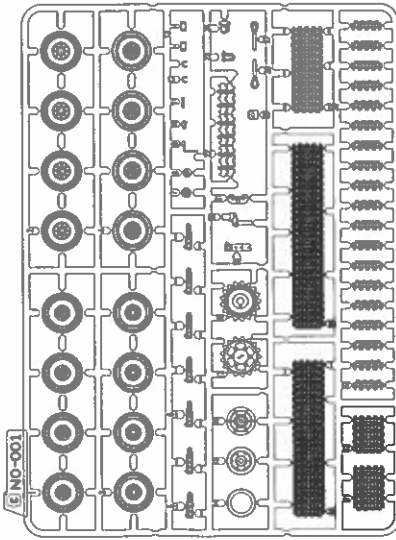

G

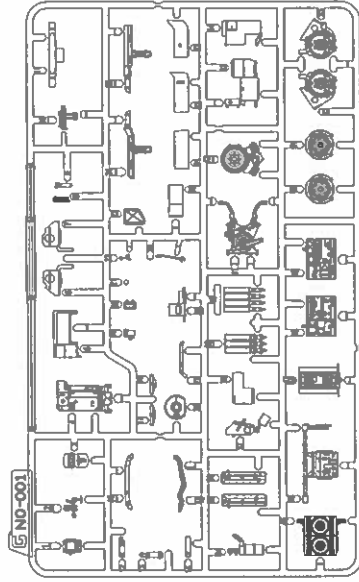

K

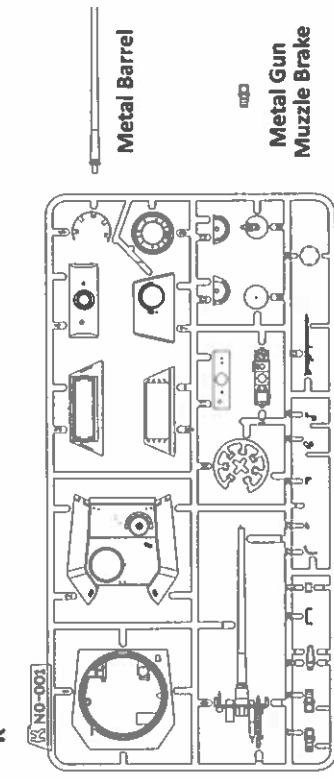

Metal Barrel

Metal Gun Muzzle Brake

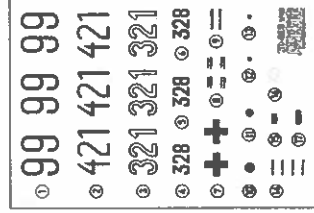

Cable

Decal

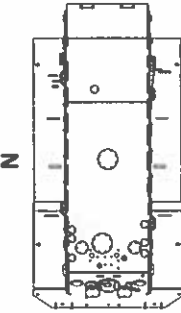

P

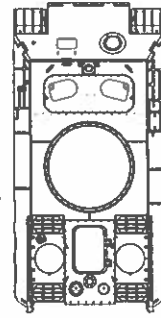

C x2

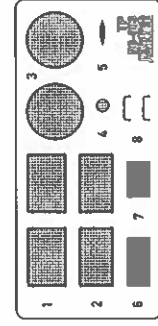
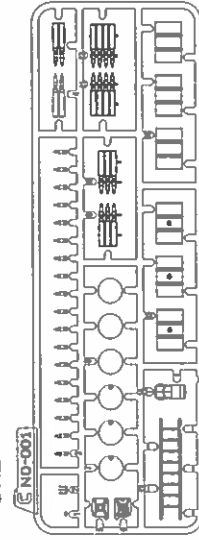

PE Part



# Zimmerit Decal

防磁水贴指示

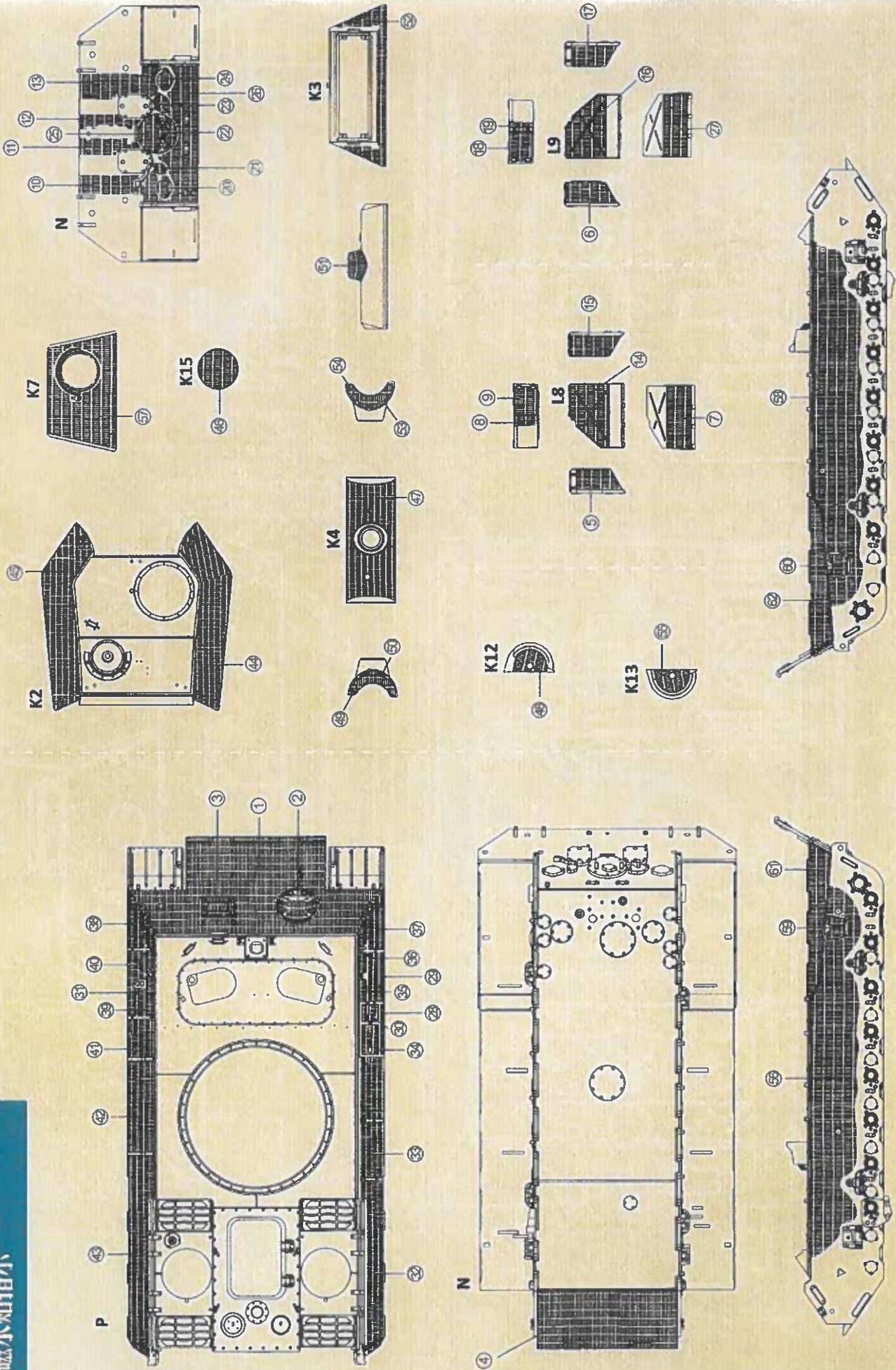



# Painting

上色指示

## Interior Painting

Panther A Family

Color info and profiles by

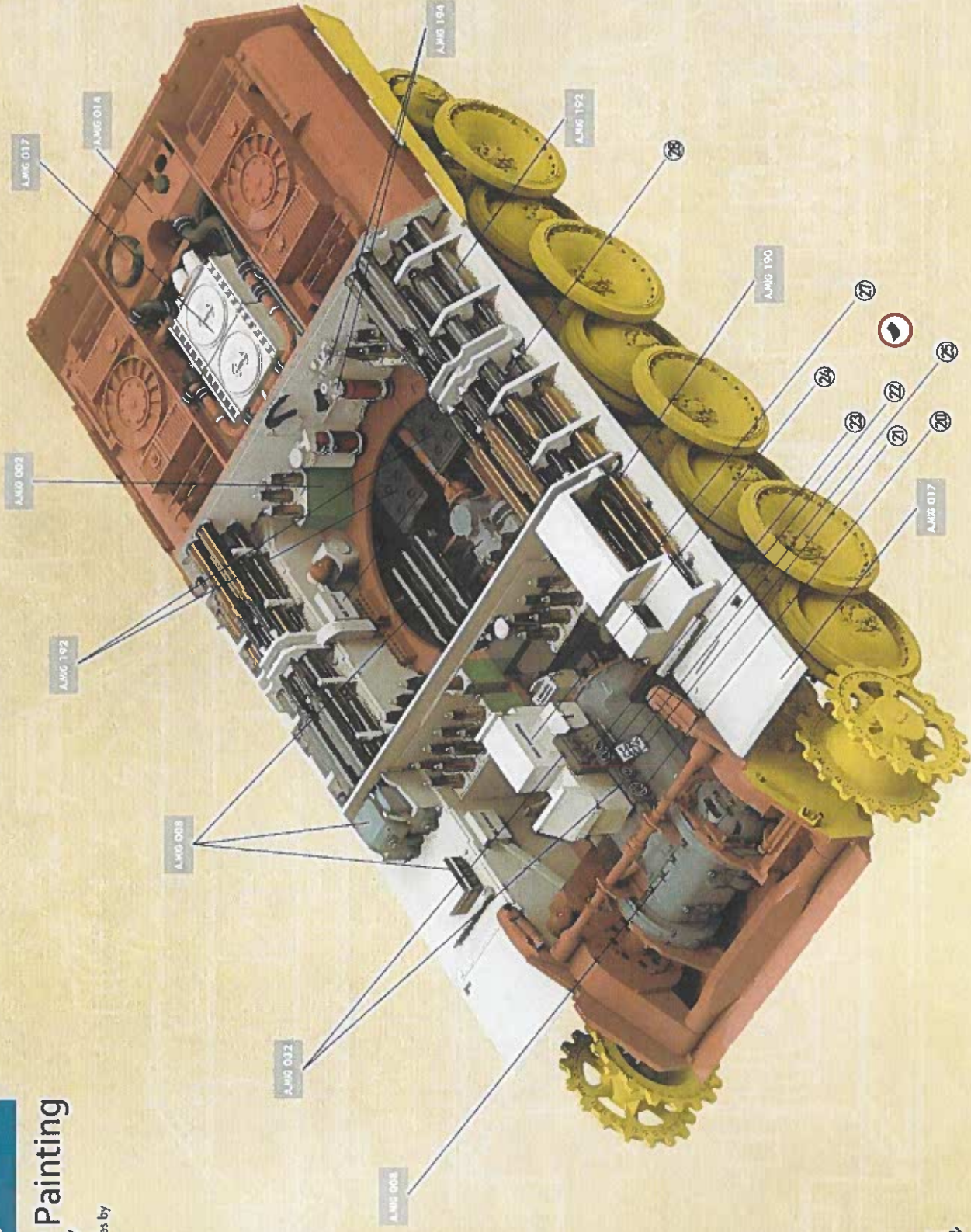

Decal  
デカール  
水貼



SUYATA



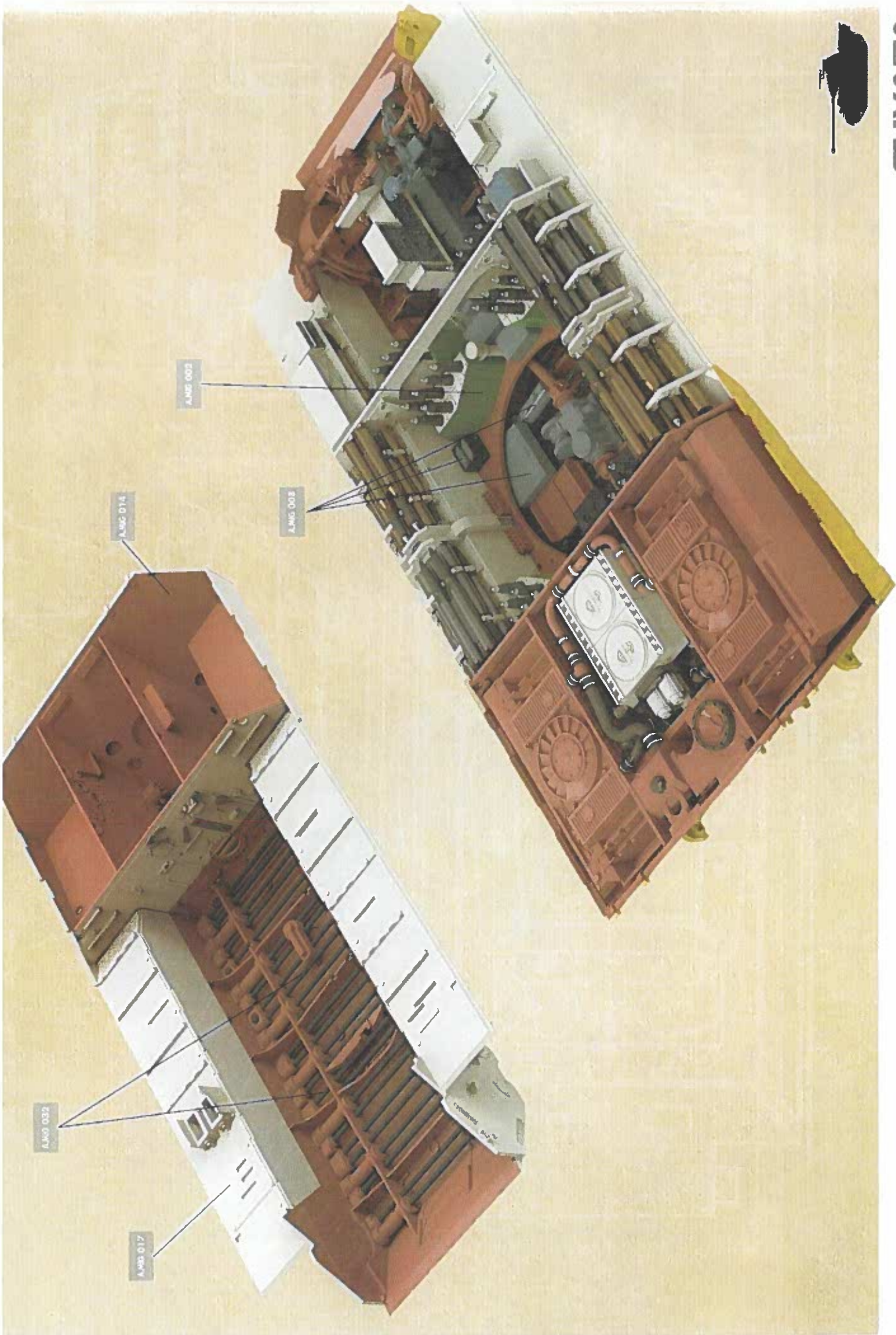

SUYATA



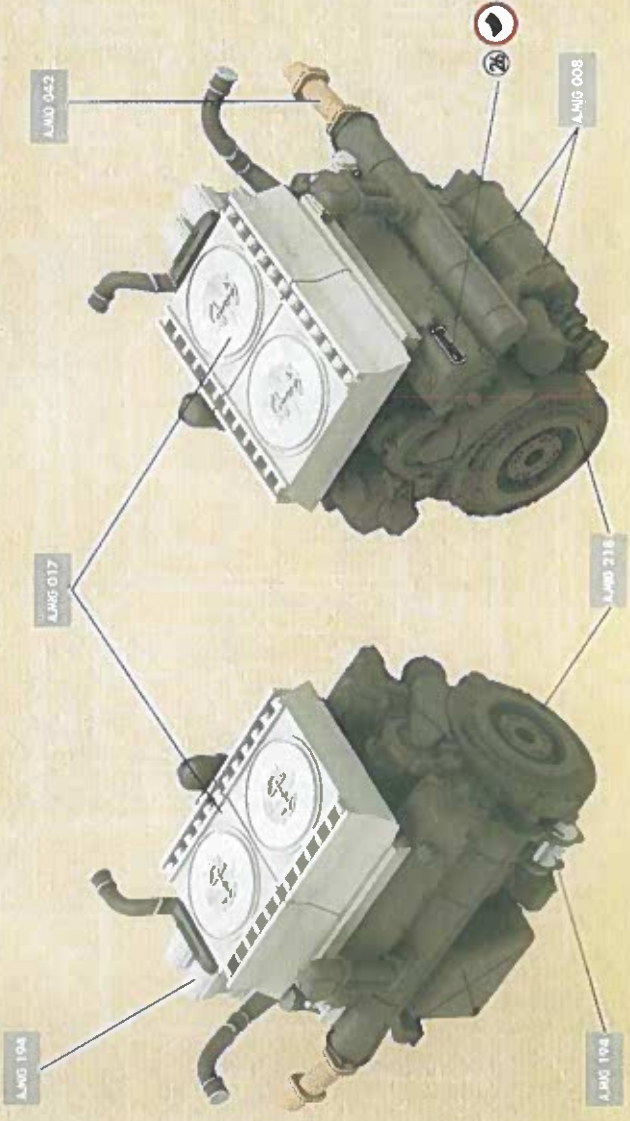
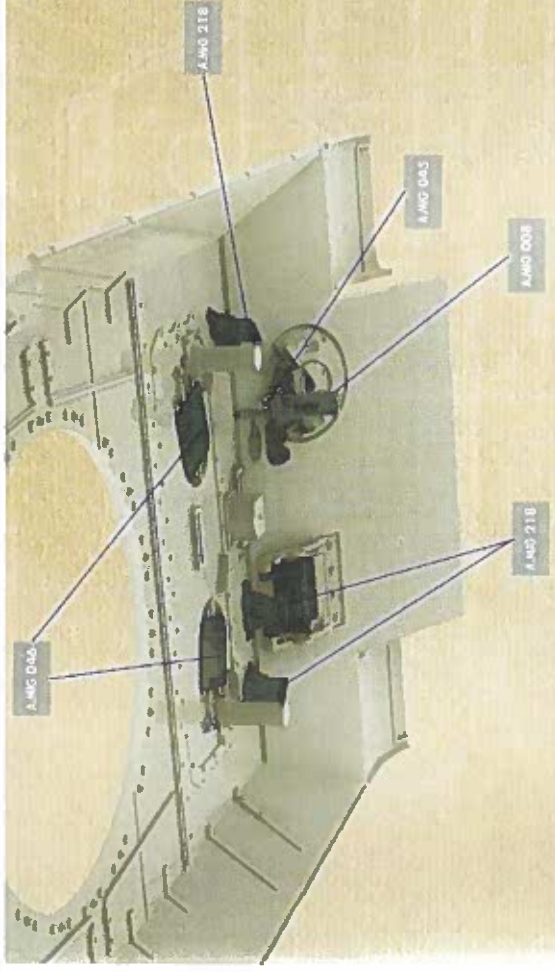
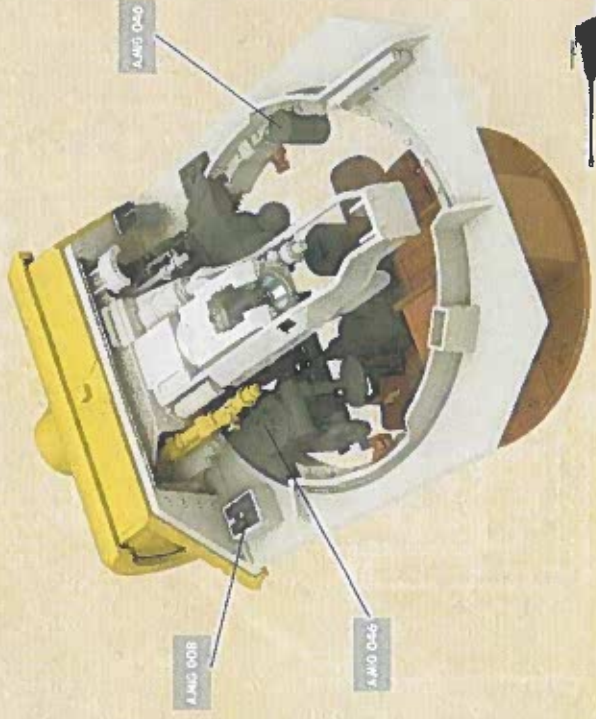
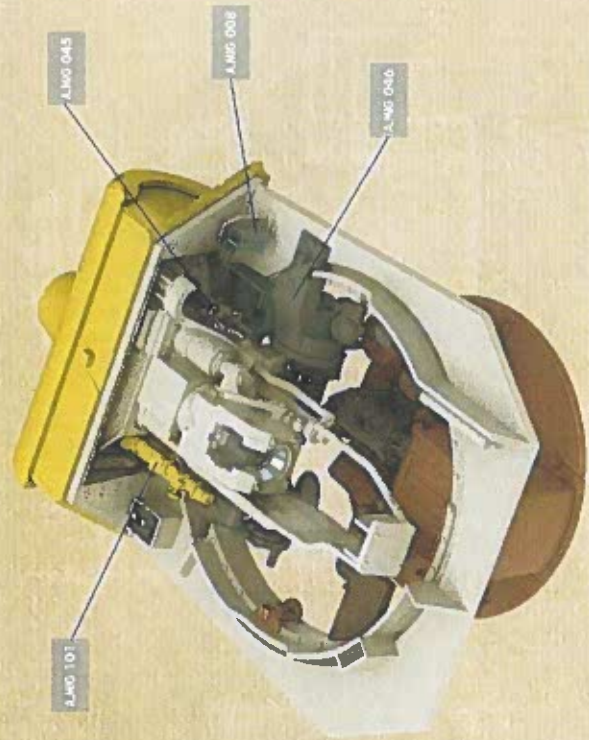



01

# 扭杆安裝 1

Attaching torsion bars 1



02

# 變速箱安裝 1

Attaching gearbox 1

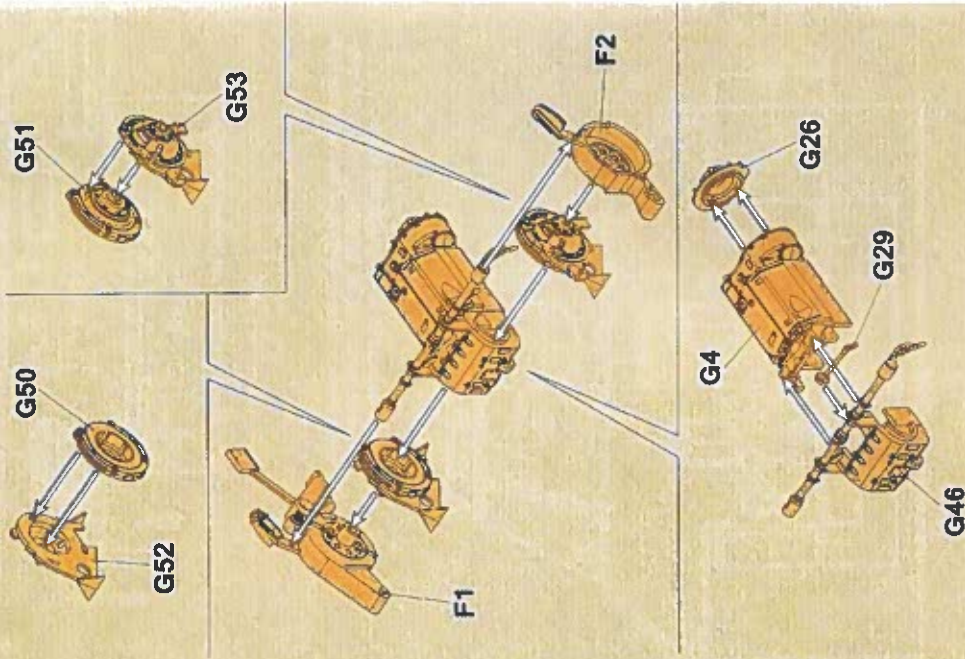
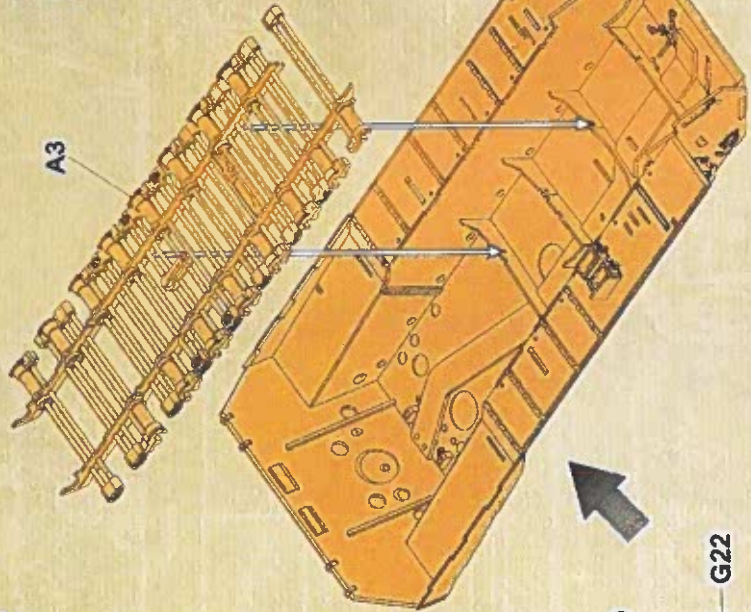



03

变速箱安装 2

Attaching gearbox 2

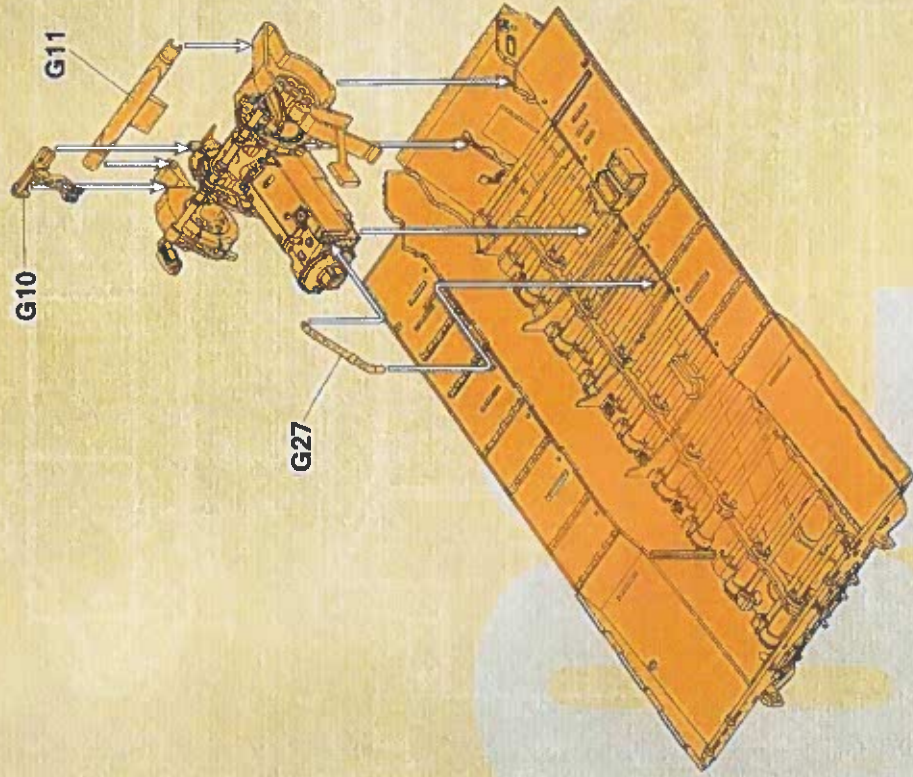

04

扭杆安装 2

Attaching torsion bars 2

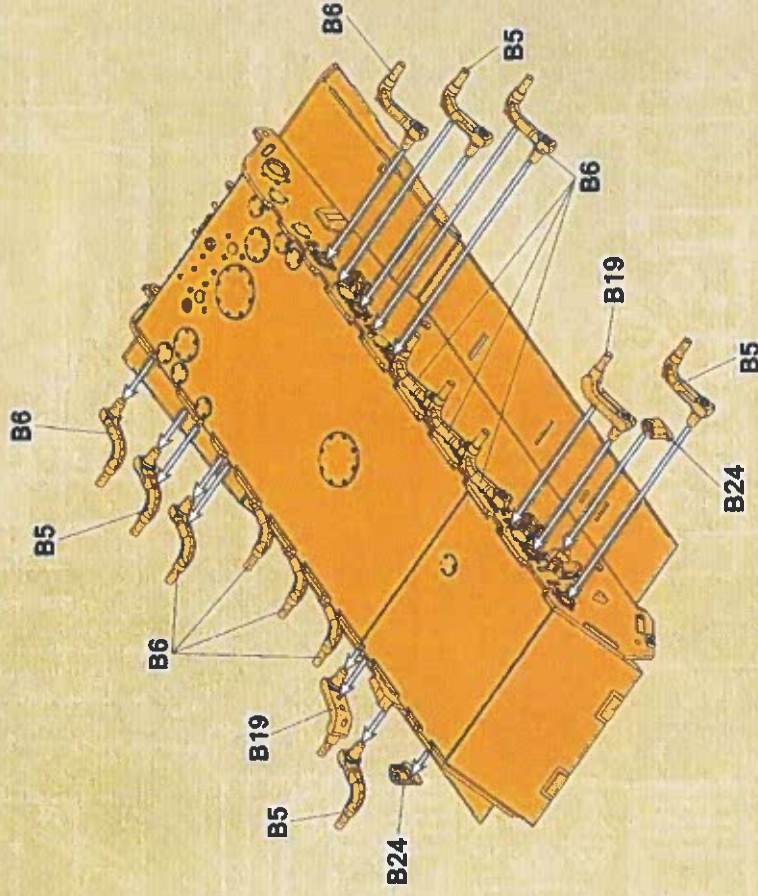

SUYATA



05

# 负重轮安装

Attaching road wheels

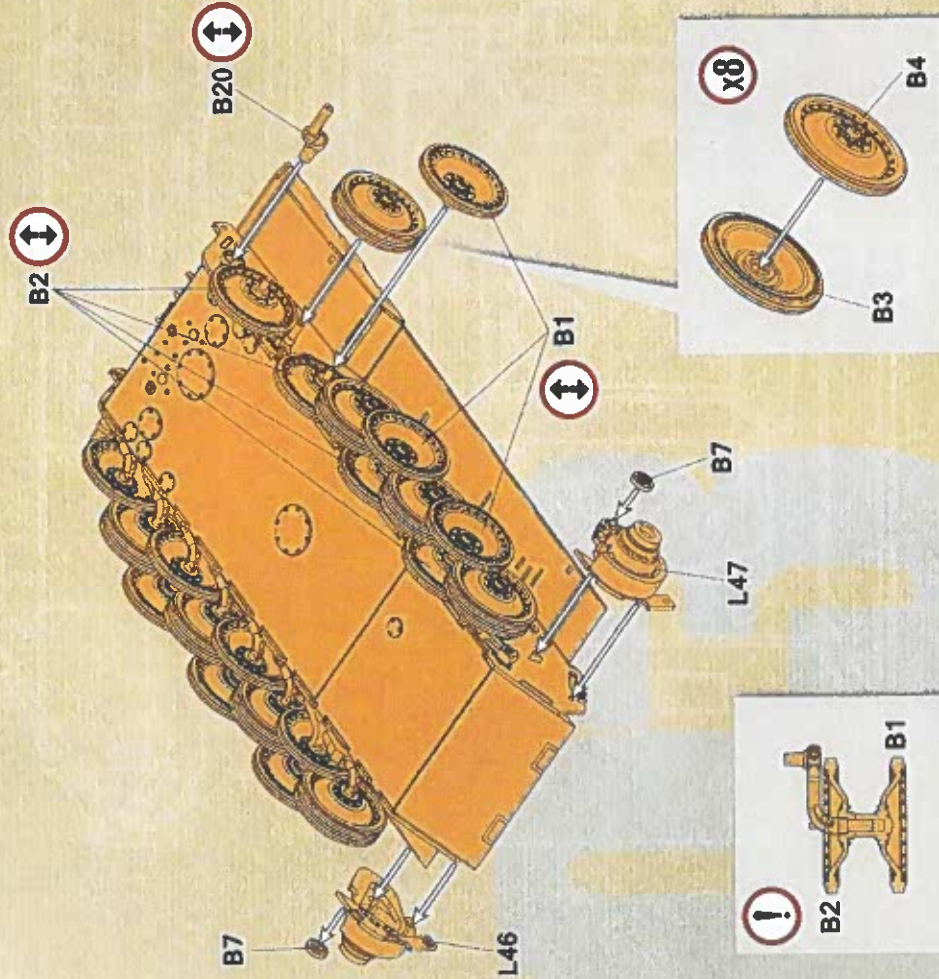

06

# 主动轮安装

Attaching drive sprockets

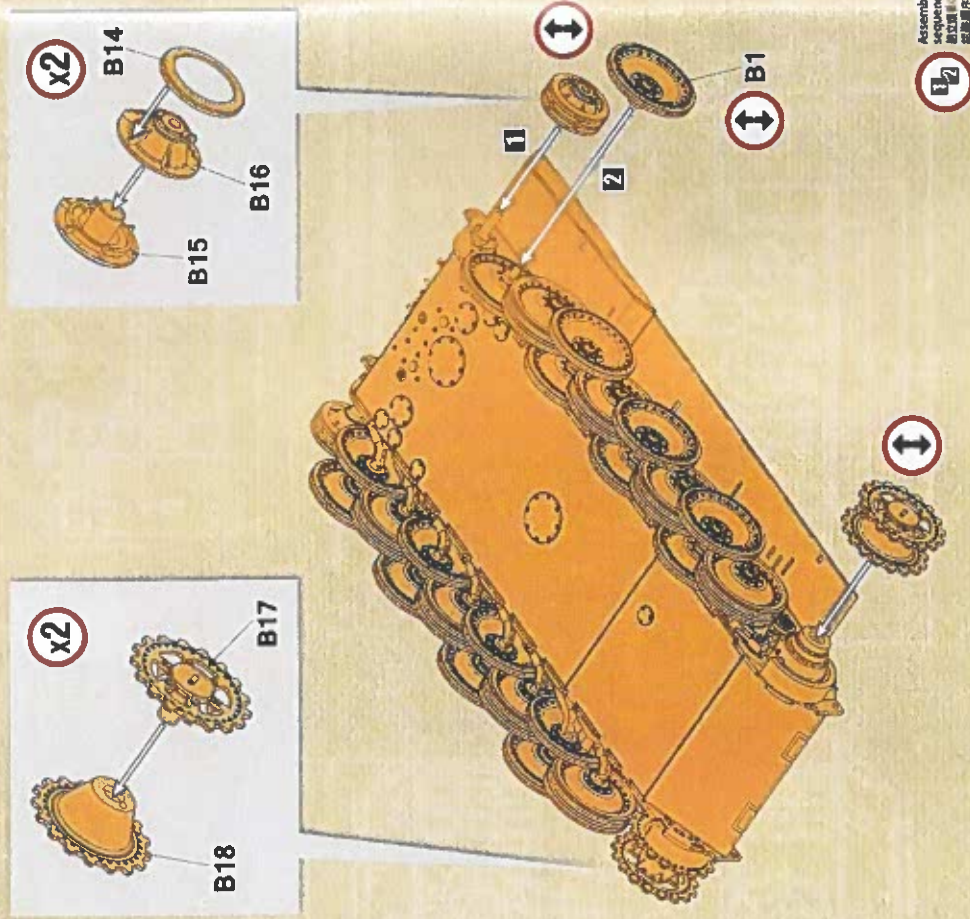

Assembly sequence  
总装顺序  
总装顺序

# SUYATA



07

# 内部组装 1



Internal structure assembly 1

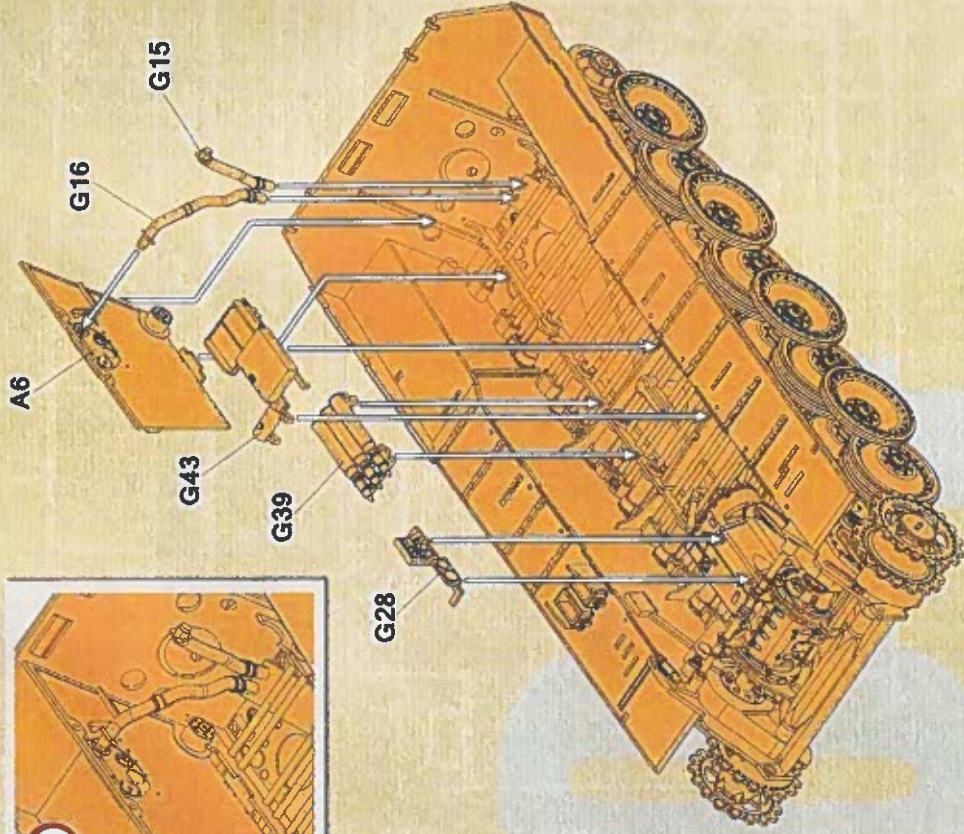

08

# 发动机安装 1



Attaching engine 1

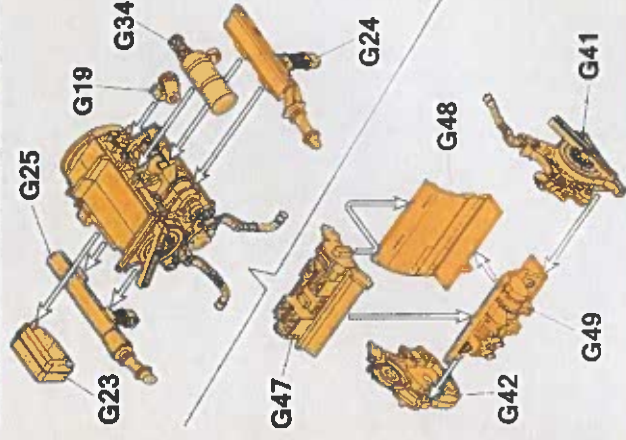
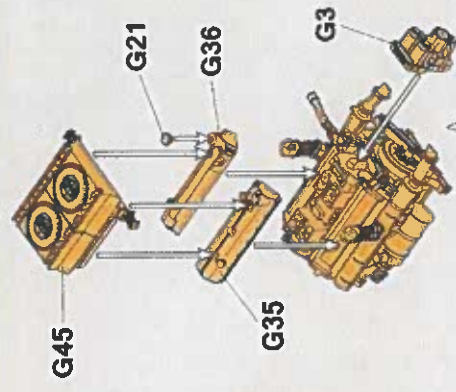
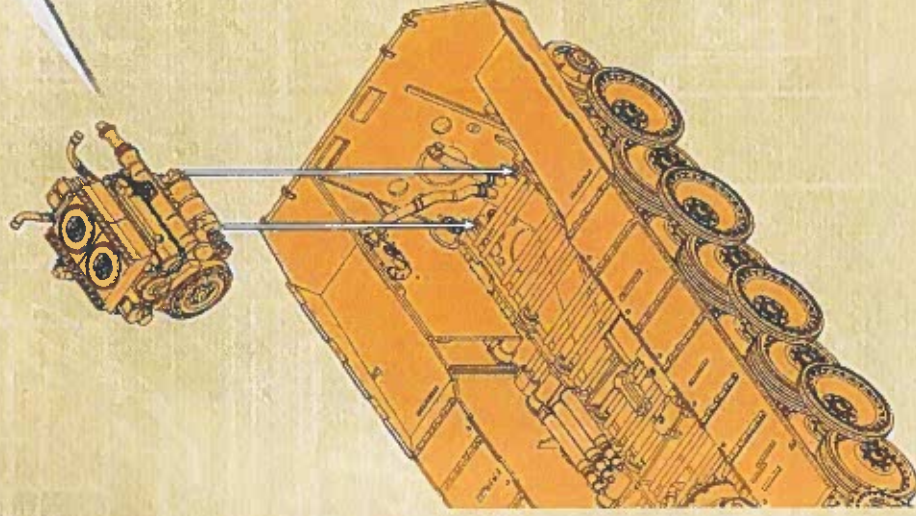

SUYATA



# 履帶安裝



Attaching tracks

# 09

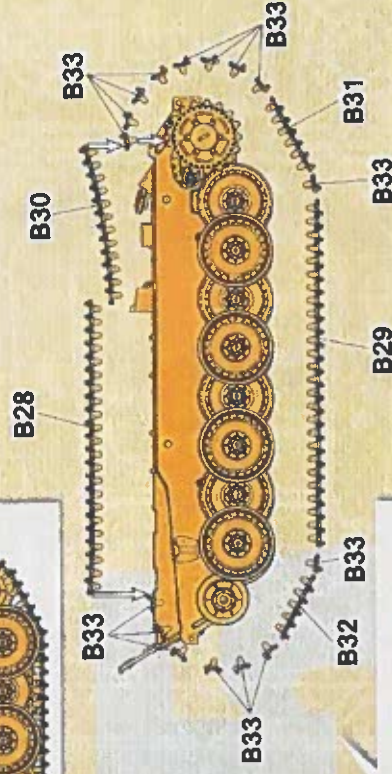
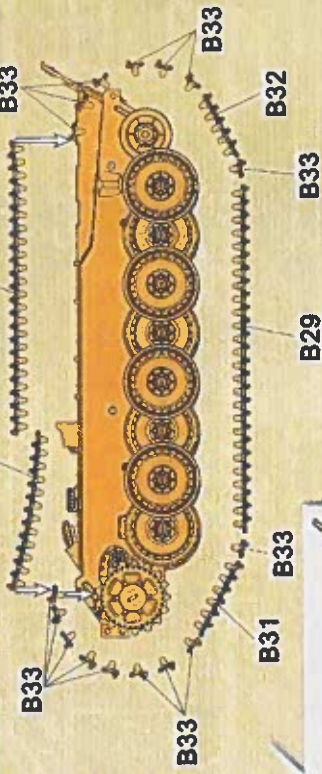
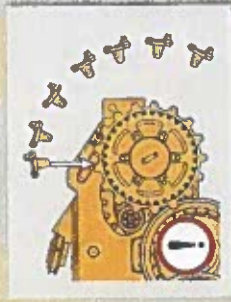
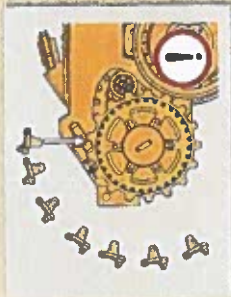

# 10

# 內部組裝 2



Internal structure assembly 2

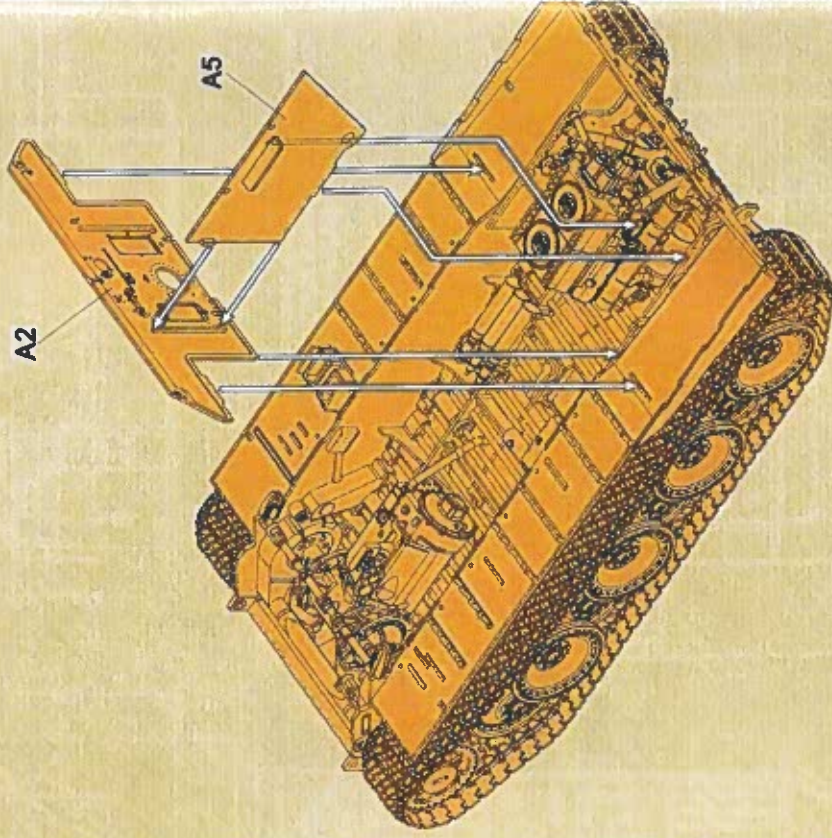

# SUYATA



# 11

## 发动机组安装 2

Attaching engine 2

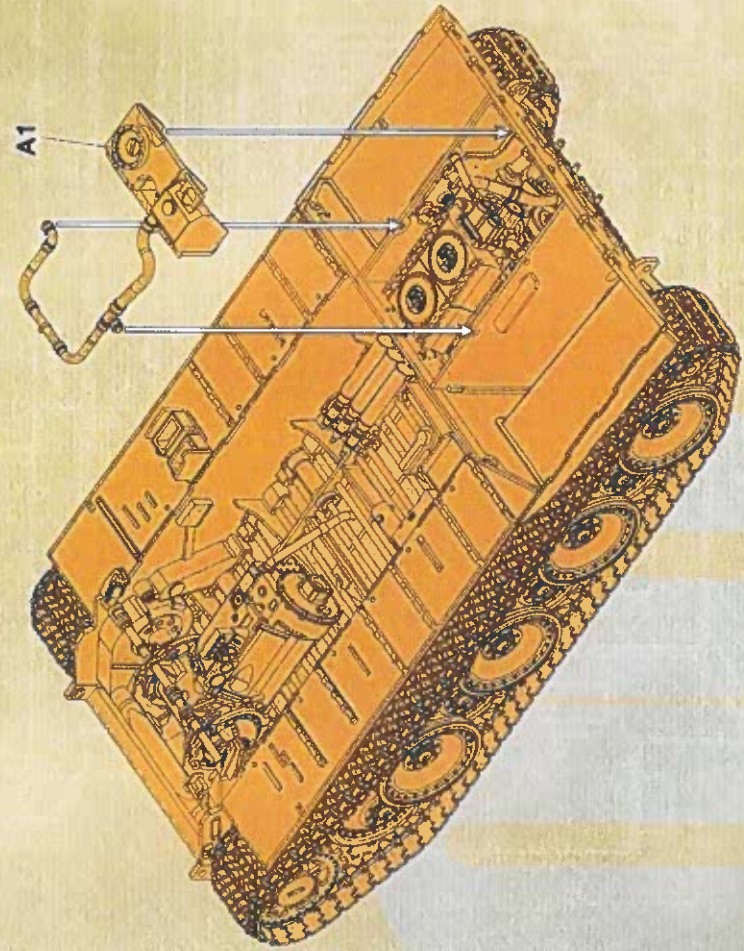

# 12

## 内部组装 3

Internal structure assembly 3

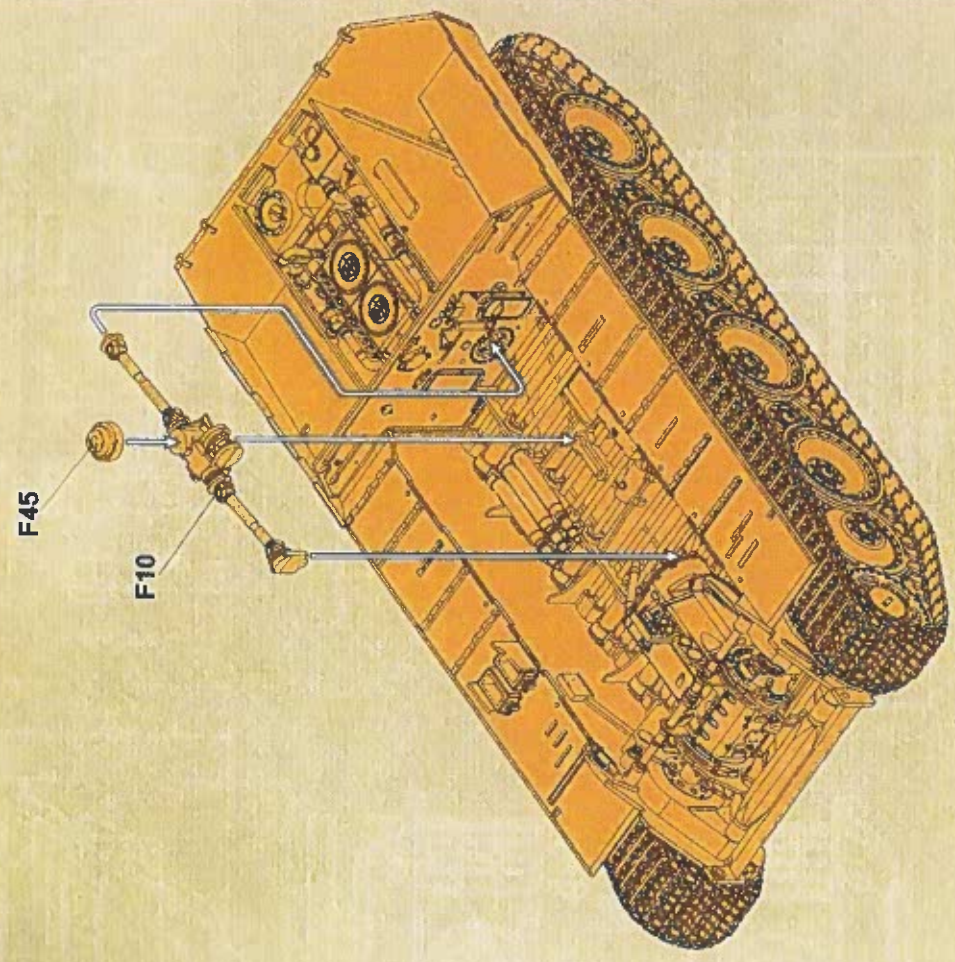



13

战斗室组装 1



Fighting compartment assembly 1

14

战斗室组装 2



Fighting compartment assembly 2

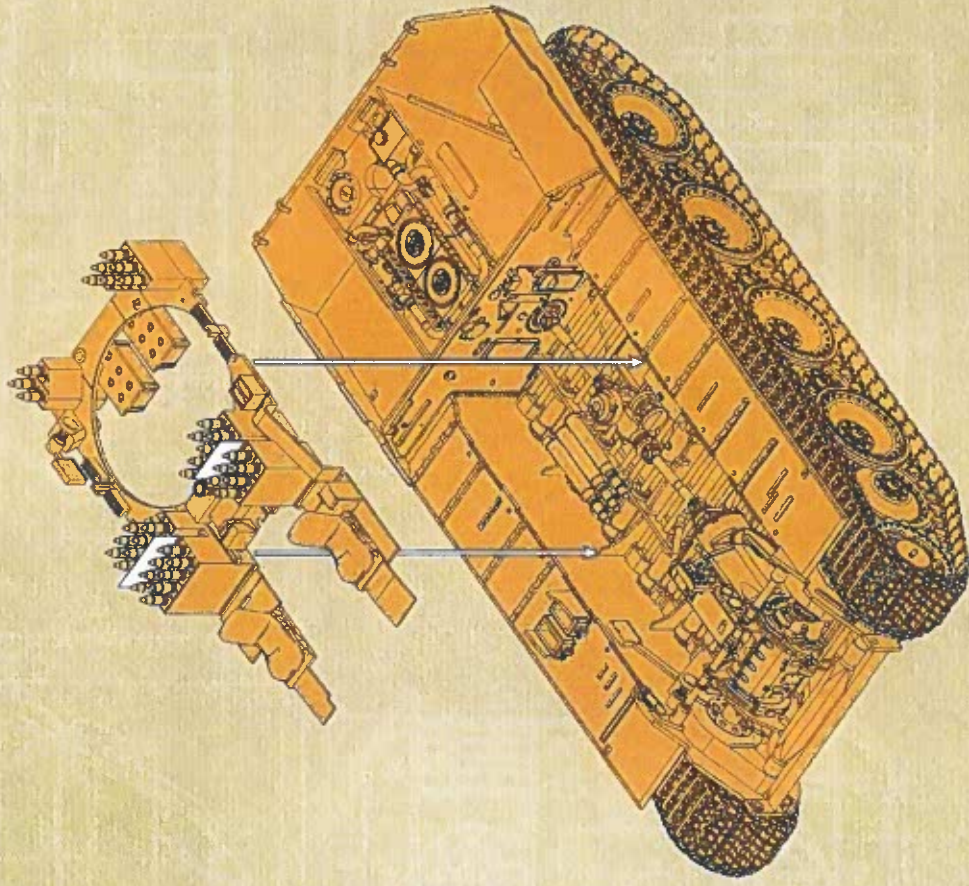
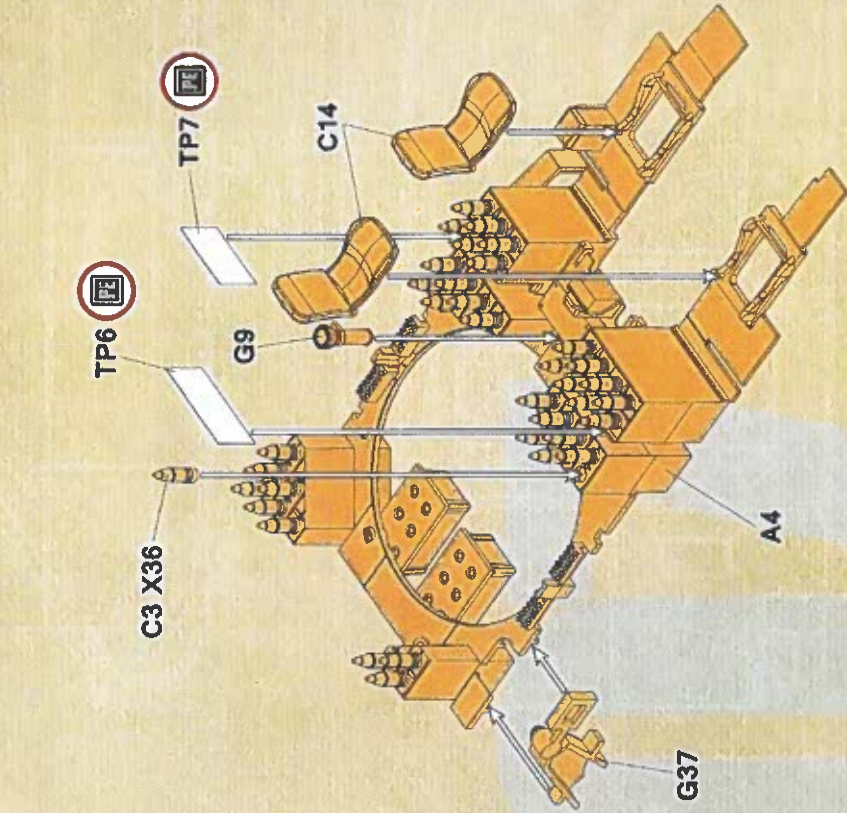



15

# 战斗室组装 3



Fighting compartment assembly 3

16

# 战斗室组装 4



Fighting compartment assembly 4

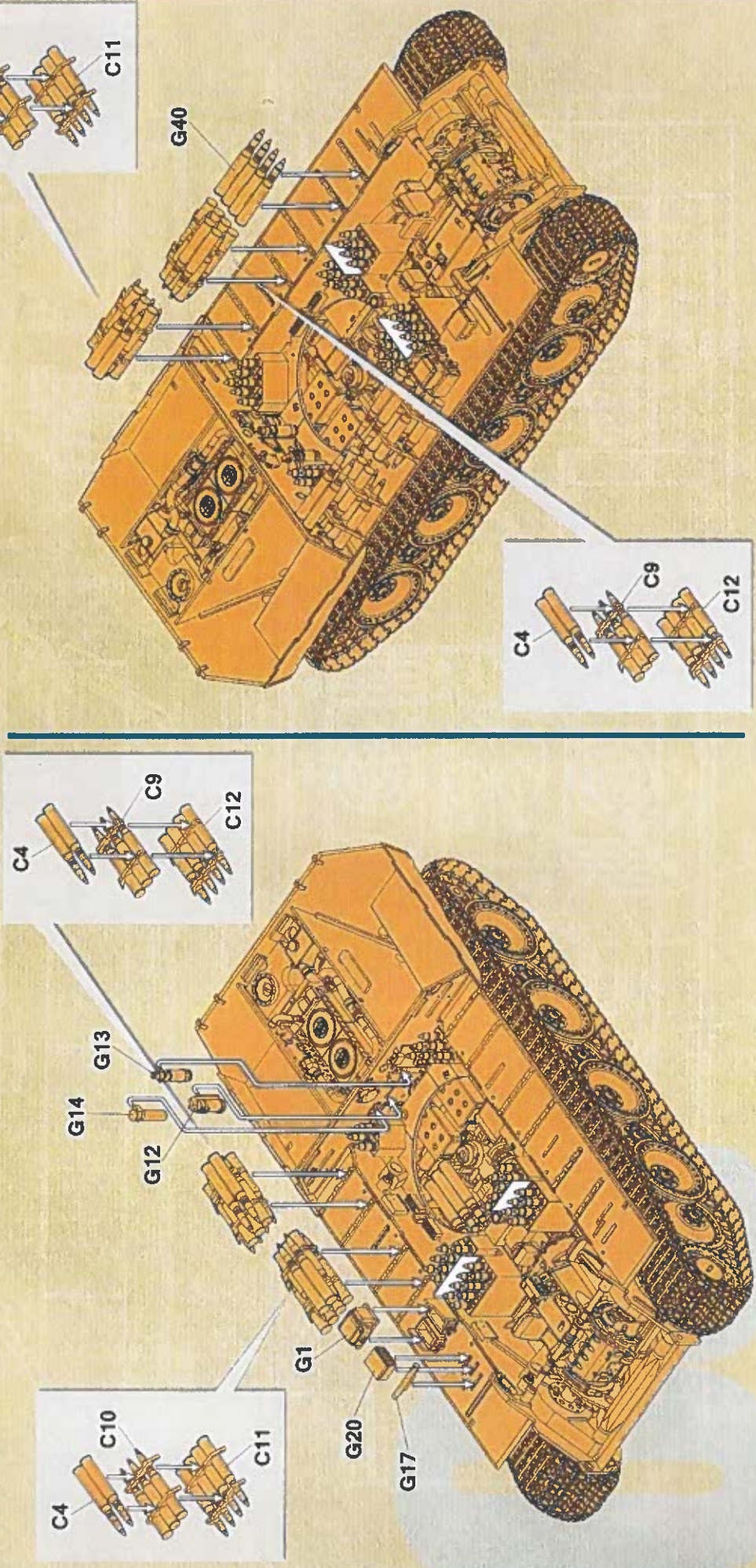



17

内部組裝 4



Internal structure assembly 4

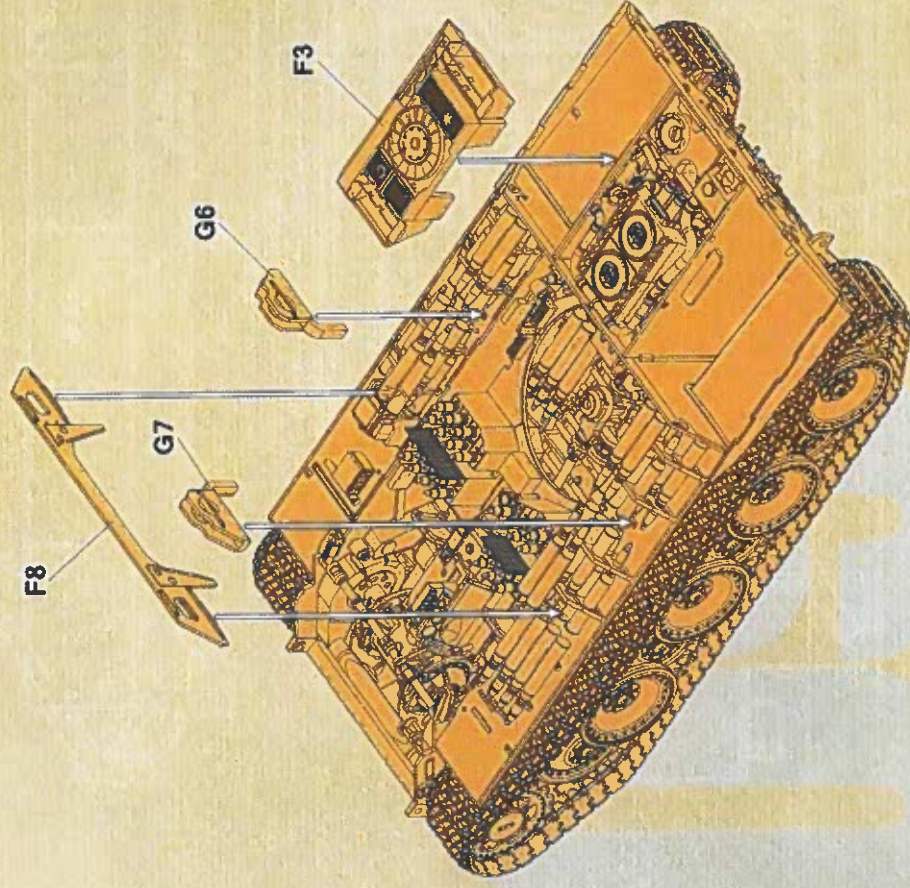

18

内部組裝 5



Internal structure assembly 5

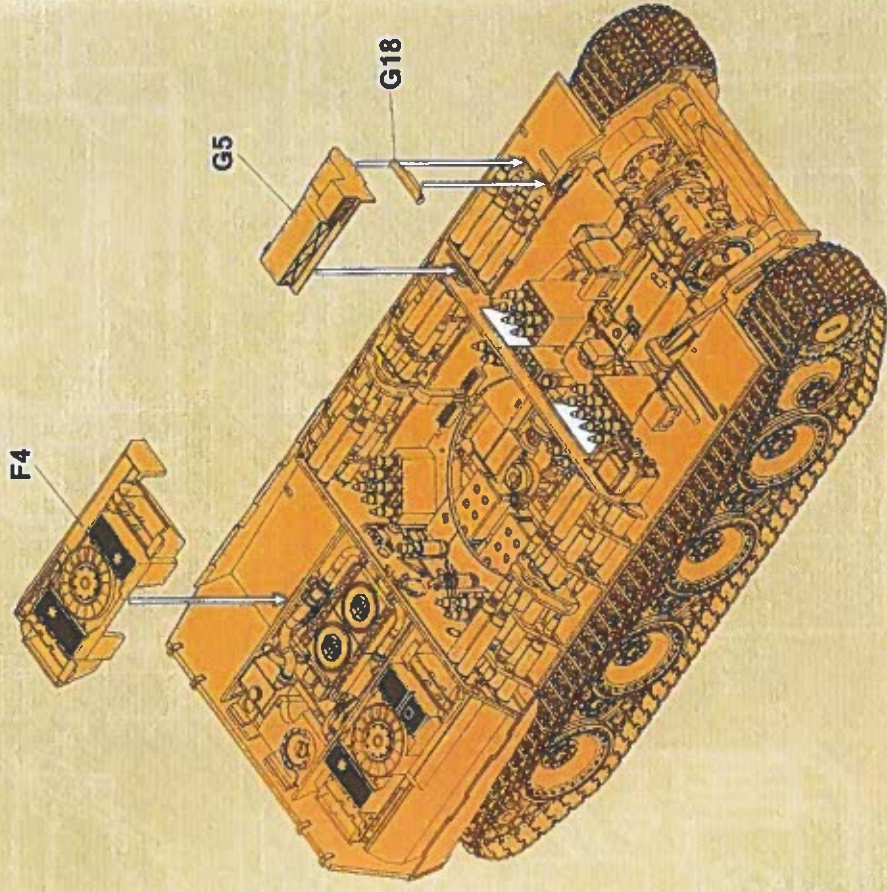



# 排气管安装

Attaching exhaust pipes



# 20

# 车体组装 I

Hull assembly 1

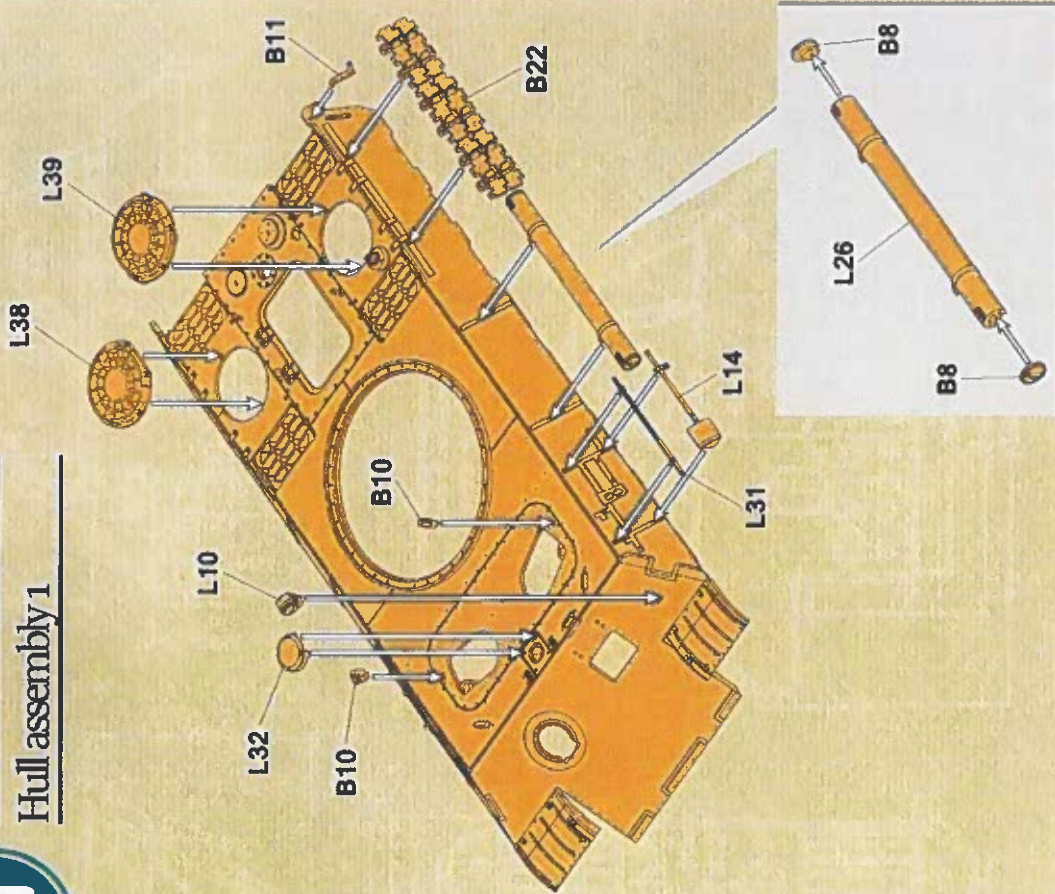
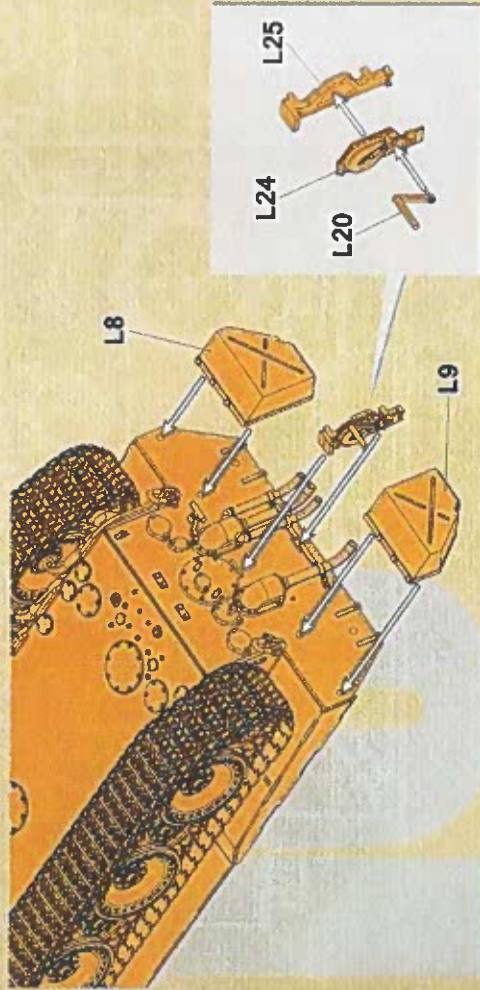
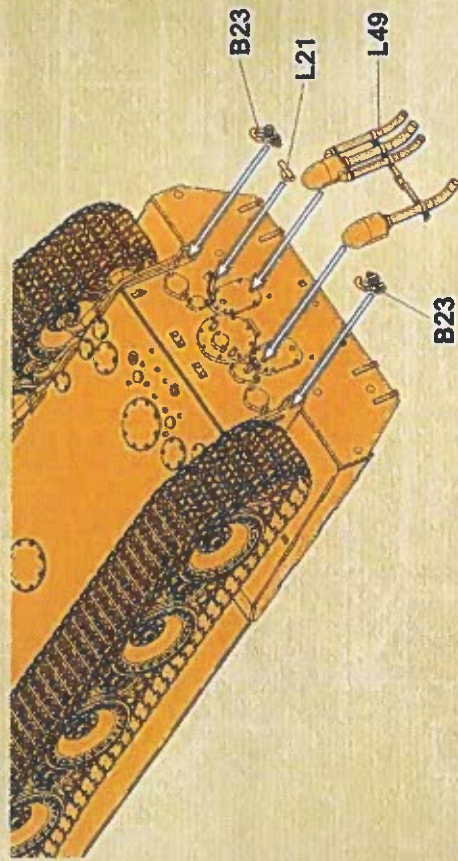



21

# 车体组装 2

Hull assembly 2



22

# 车体组装 3

Hull assembly 3

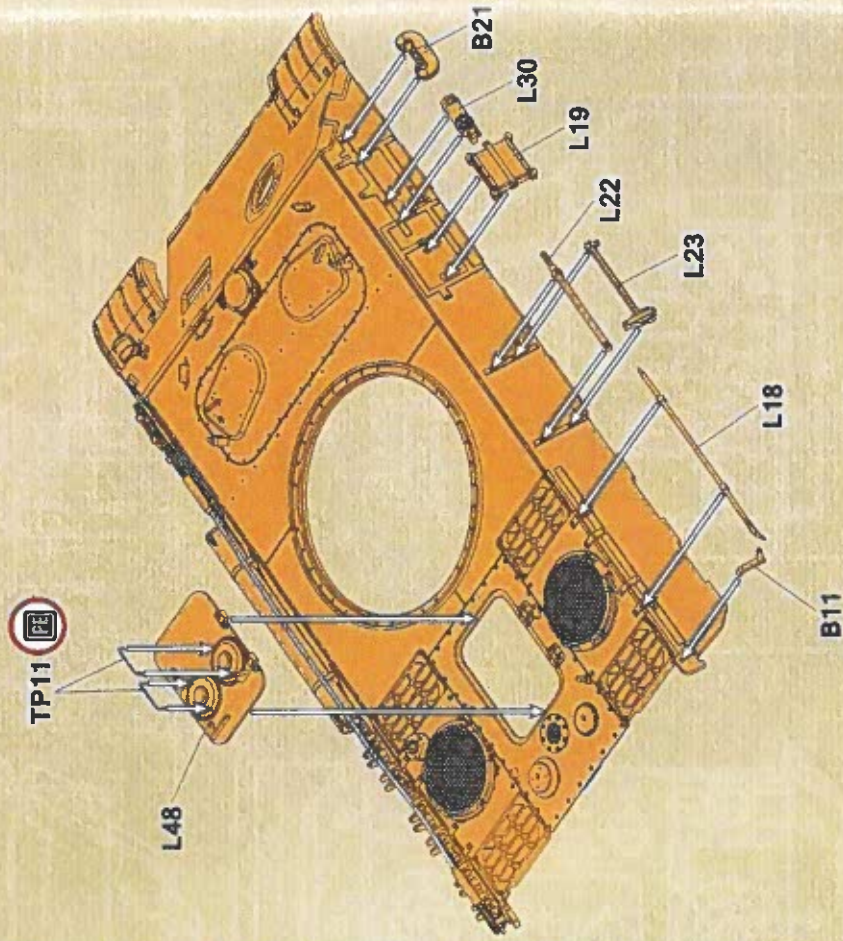
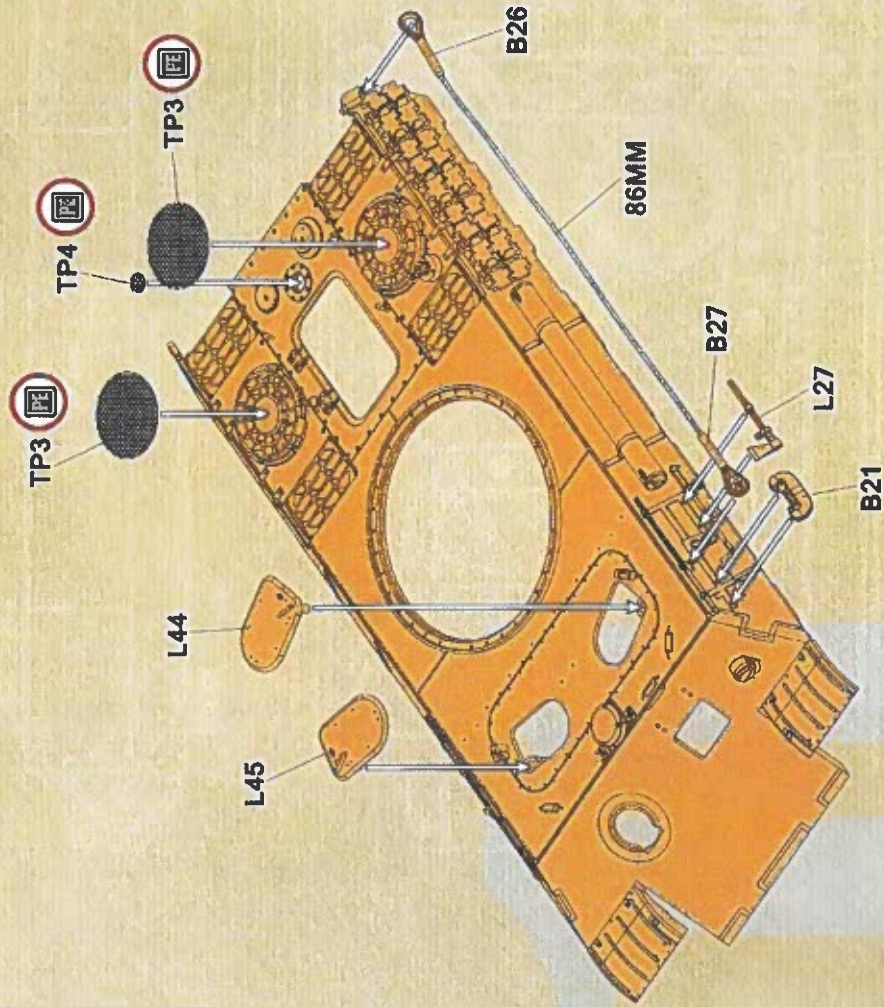



23

# 车体组装 4

Hull assembly 4

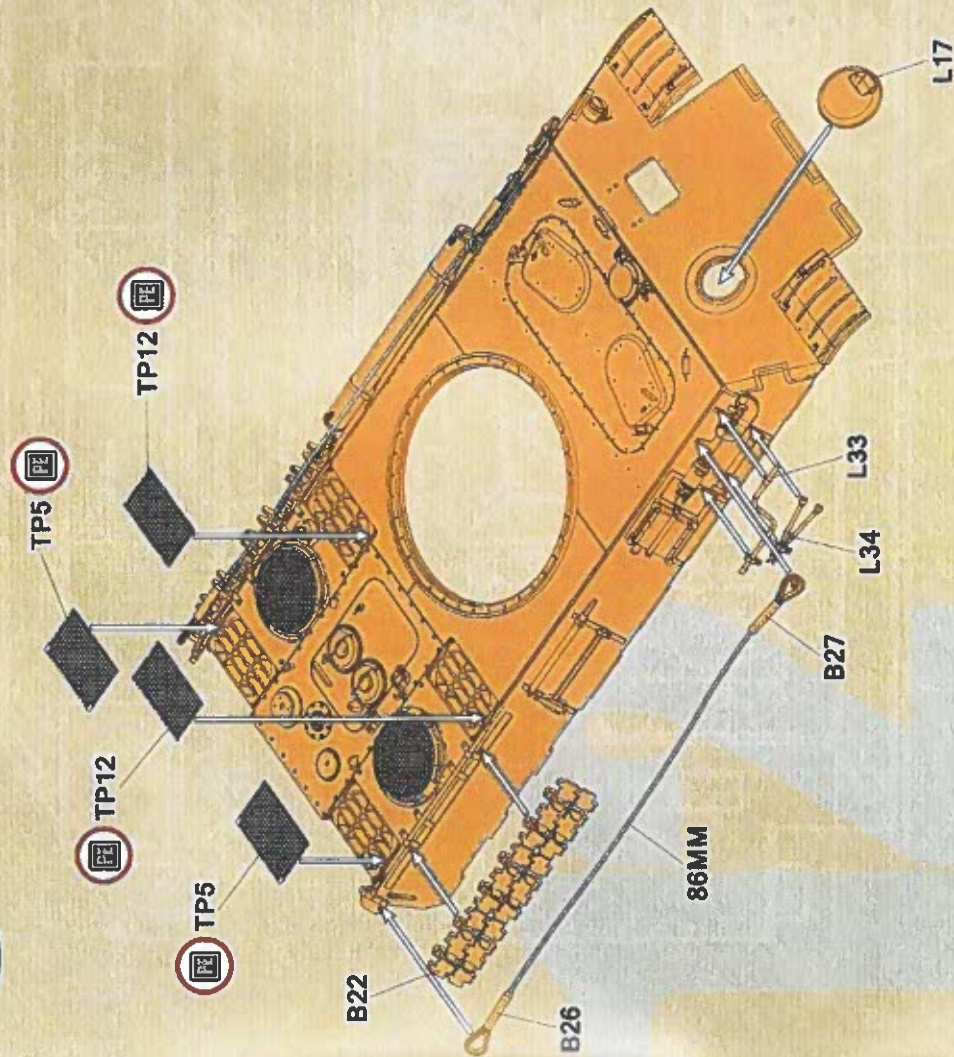

24

# 机枪安装

Attaching machine gun

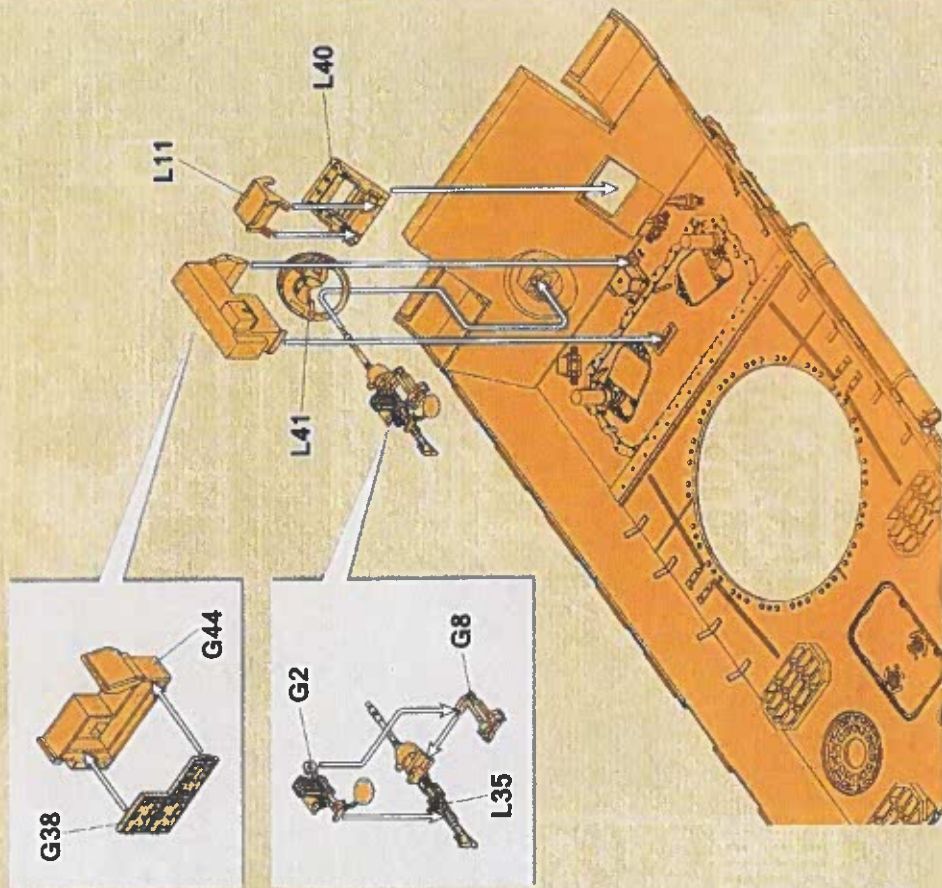



25

车体组装 5

Hull assembly 5

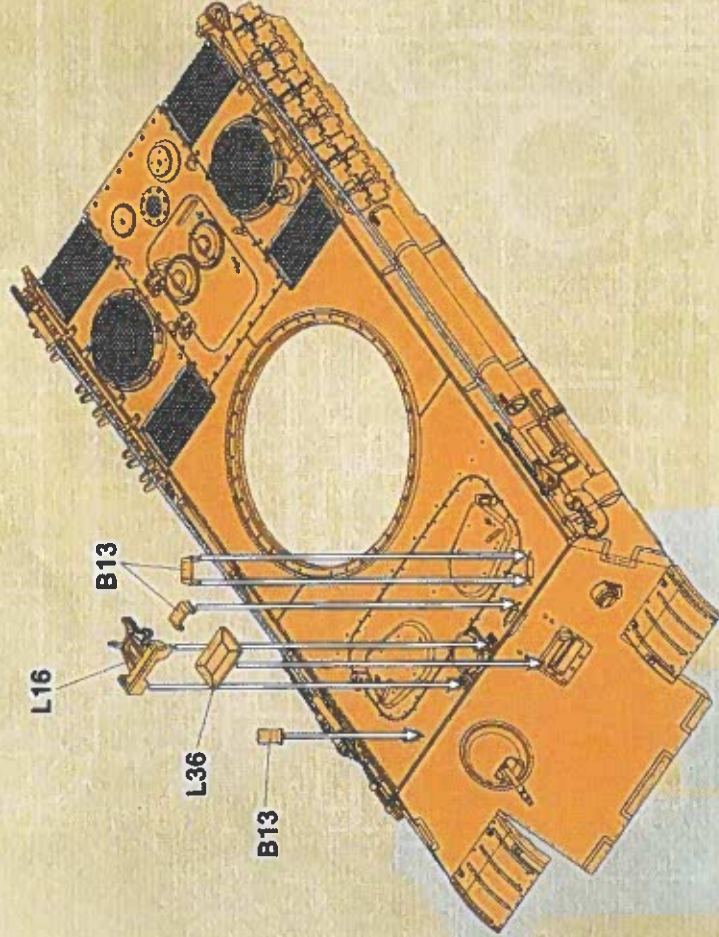

26

车体组装 6

Hull assembly 6

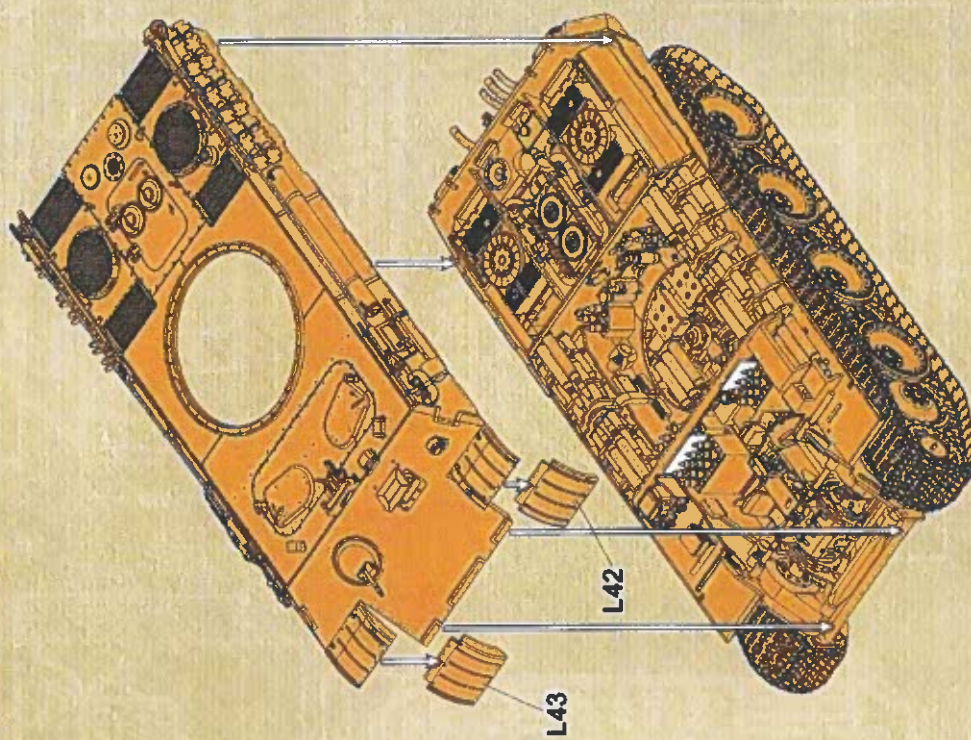



27

裙板安裝

Attaching side skirts

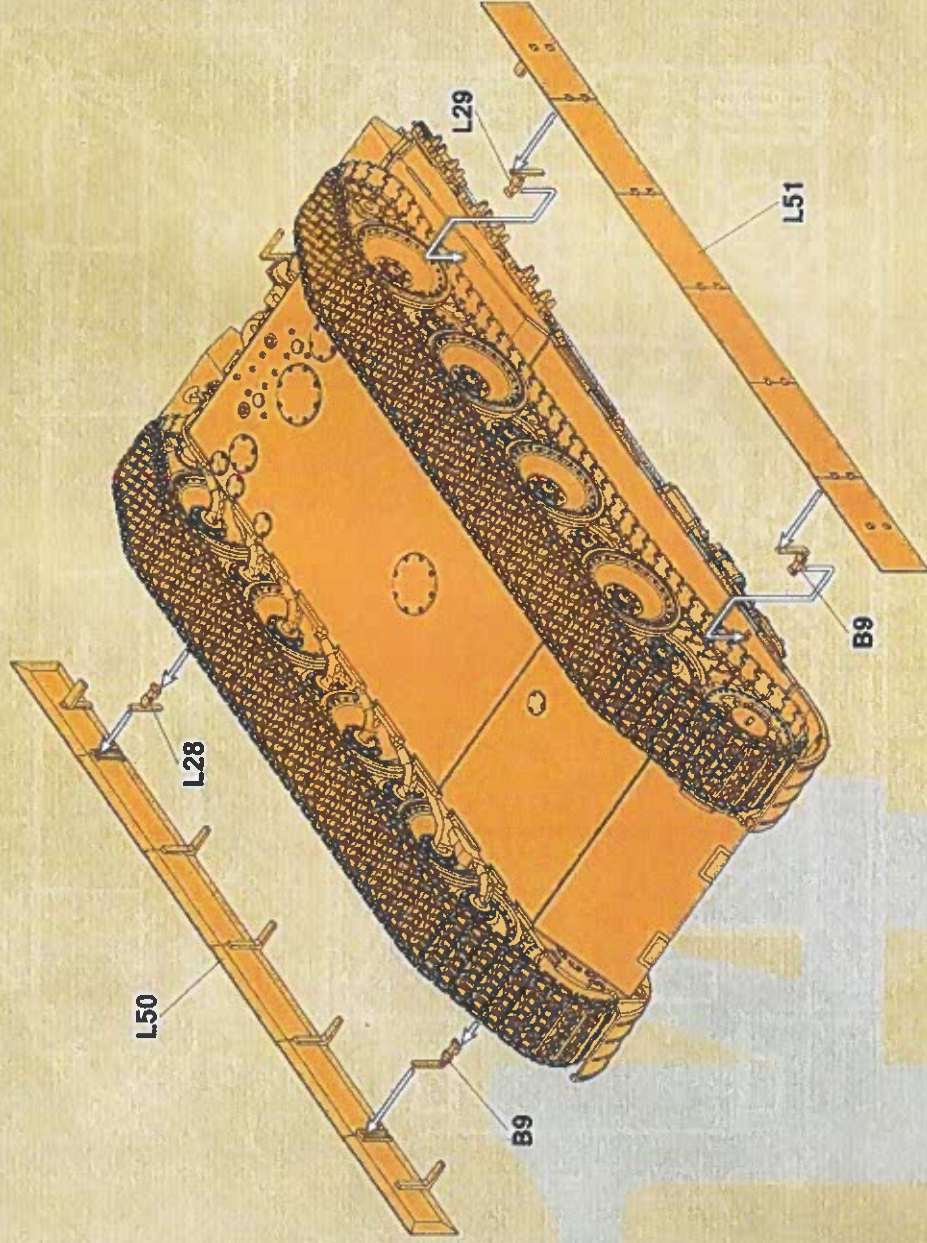

28

炮塔組裝 1

Turret assembly 1

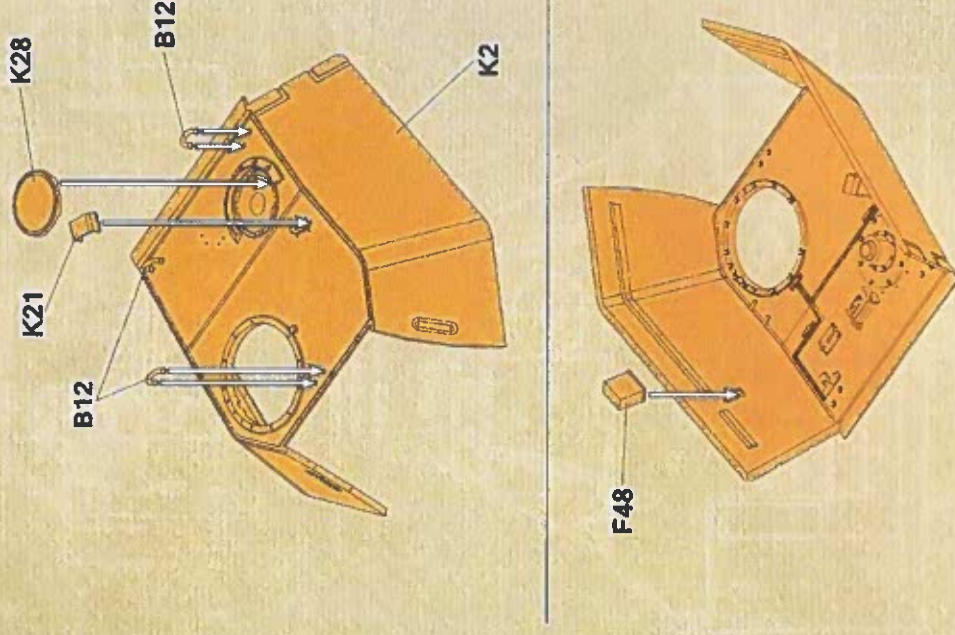



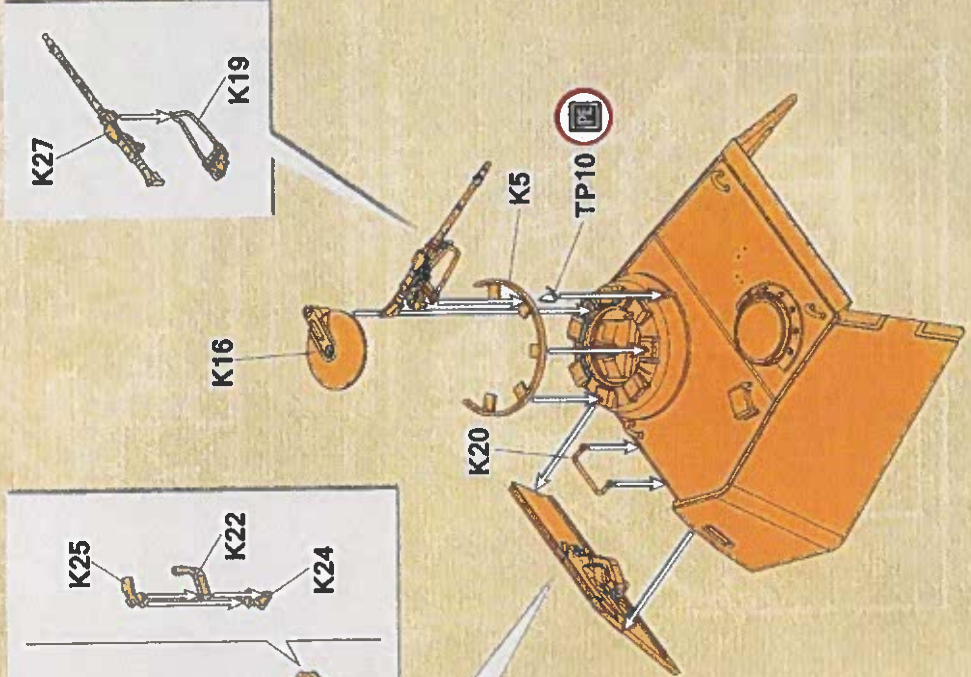
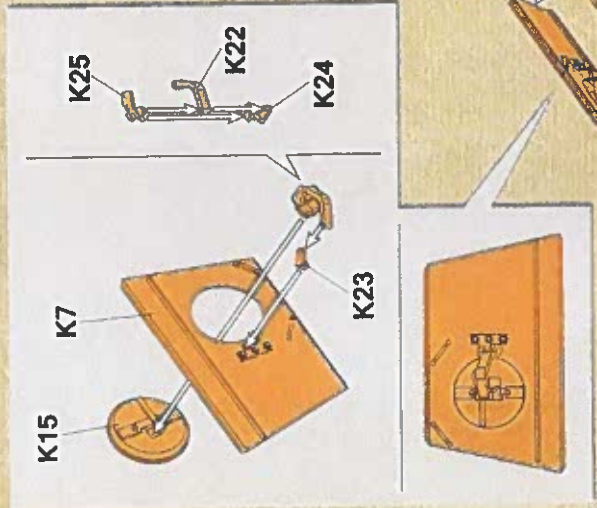
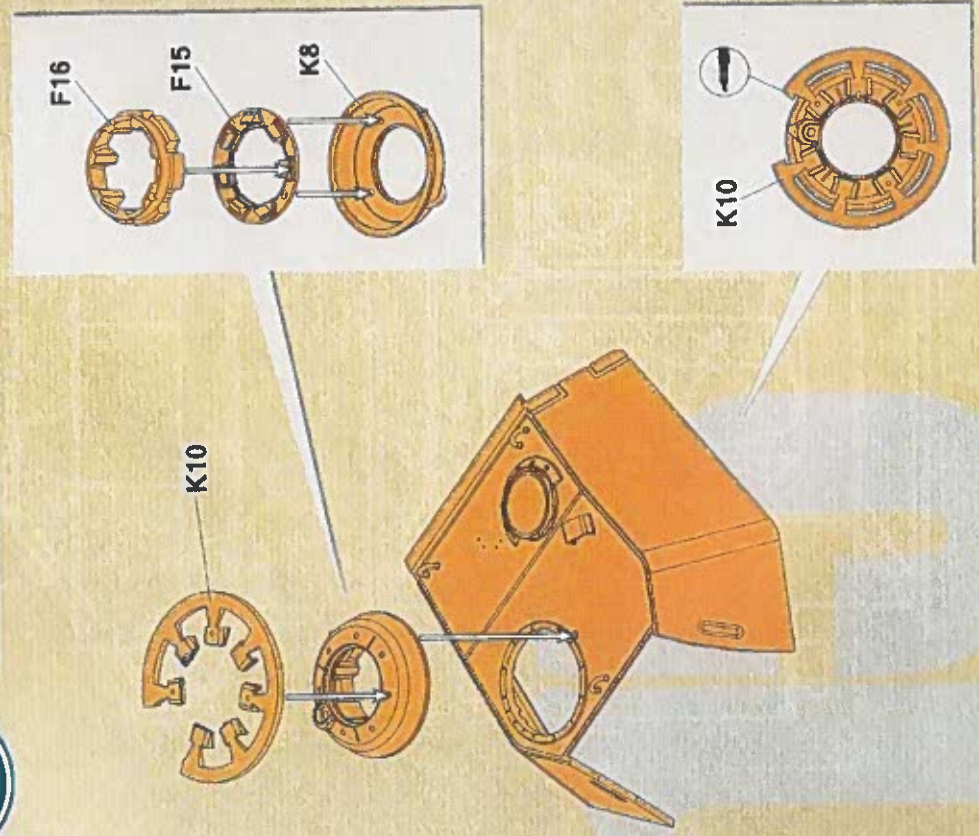



# 炮塔组装 3



Turret assembly 3

## 30

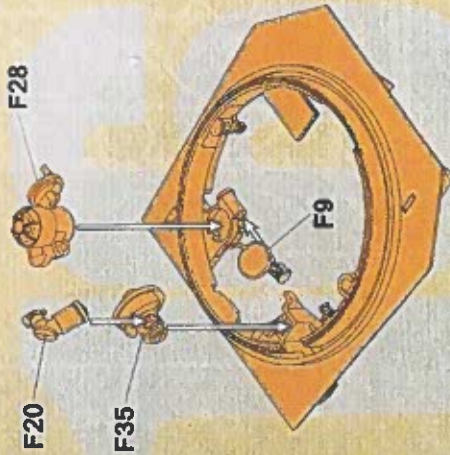
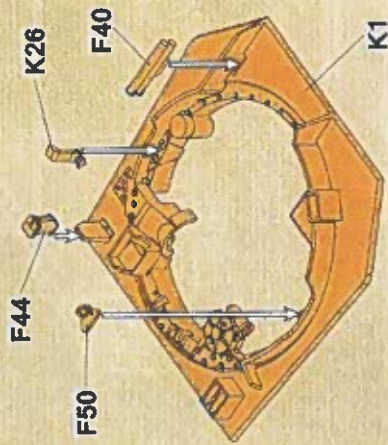

## 31

# 炮塔组装 4



Turret assembly 4

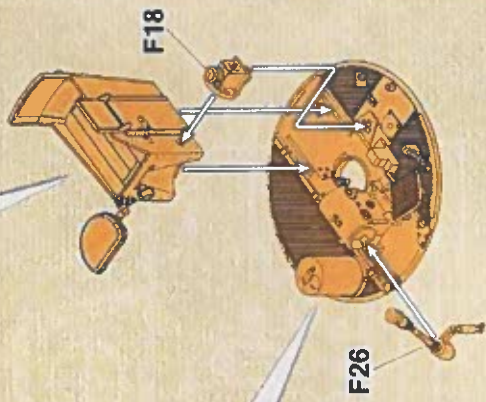
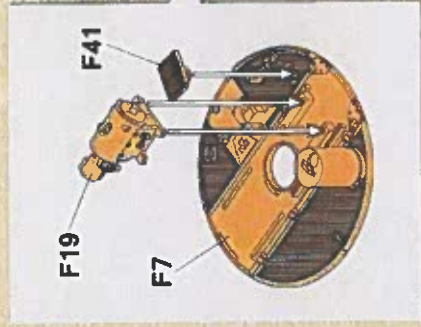
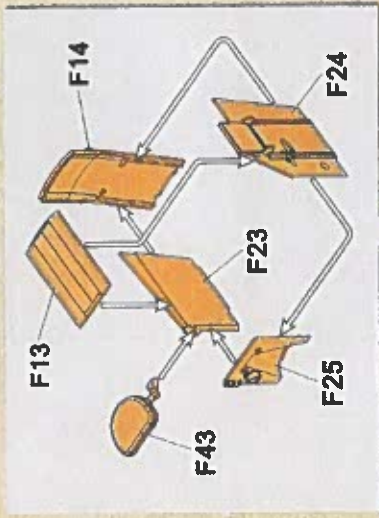
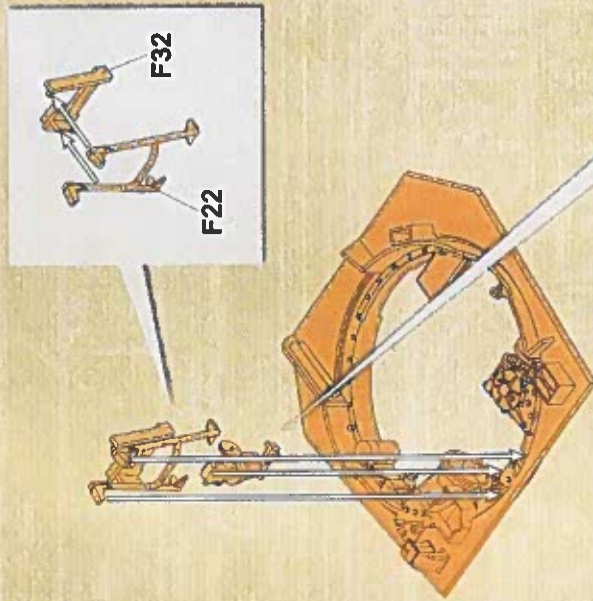

# SUYATA



32

炮塔组装 5

Turret assembly 5



33

火炮组装 1

Gun assembly 1

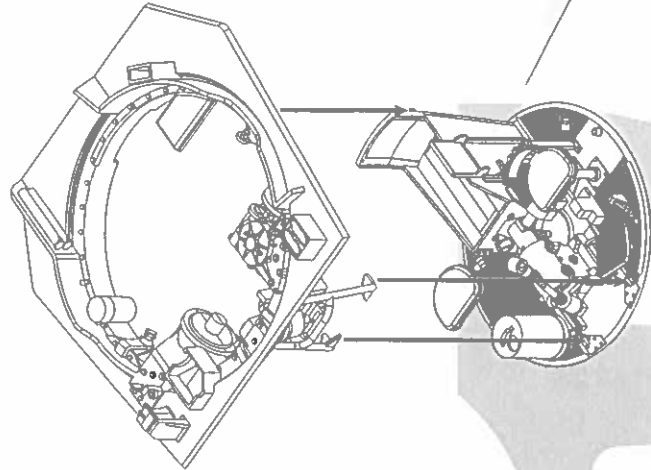

F29

F42

F31

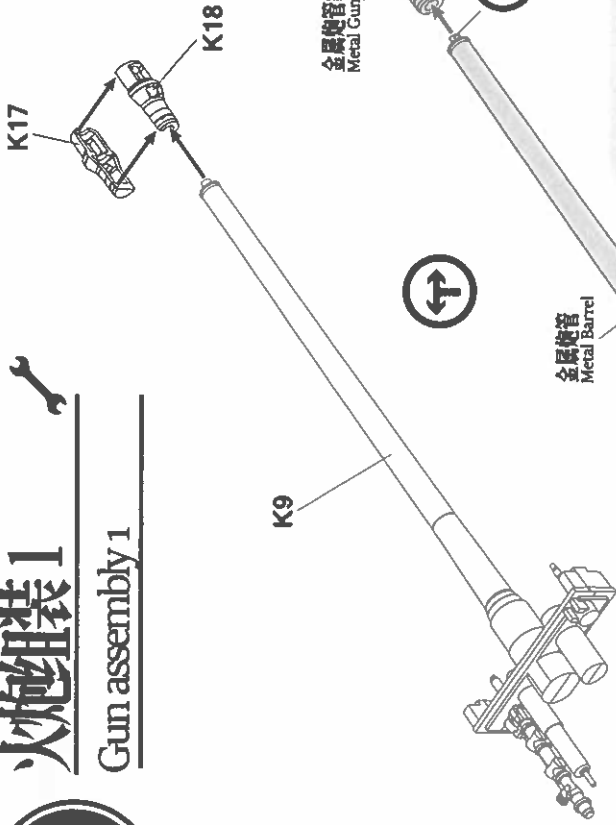

金属炮管制退器  
Metal Gun Muzzle Brake

金属炮管  
Metal Barrel

Φ:2MM h:3MM



34

火炮組裝 2



Gun assembly 2

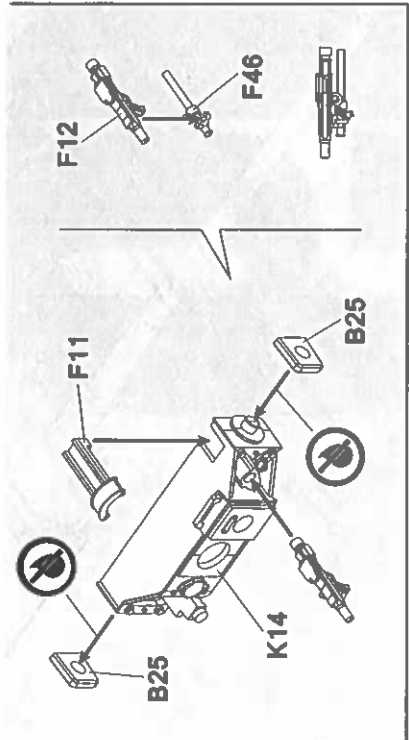
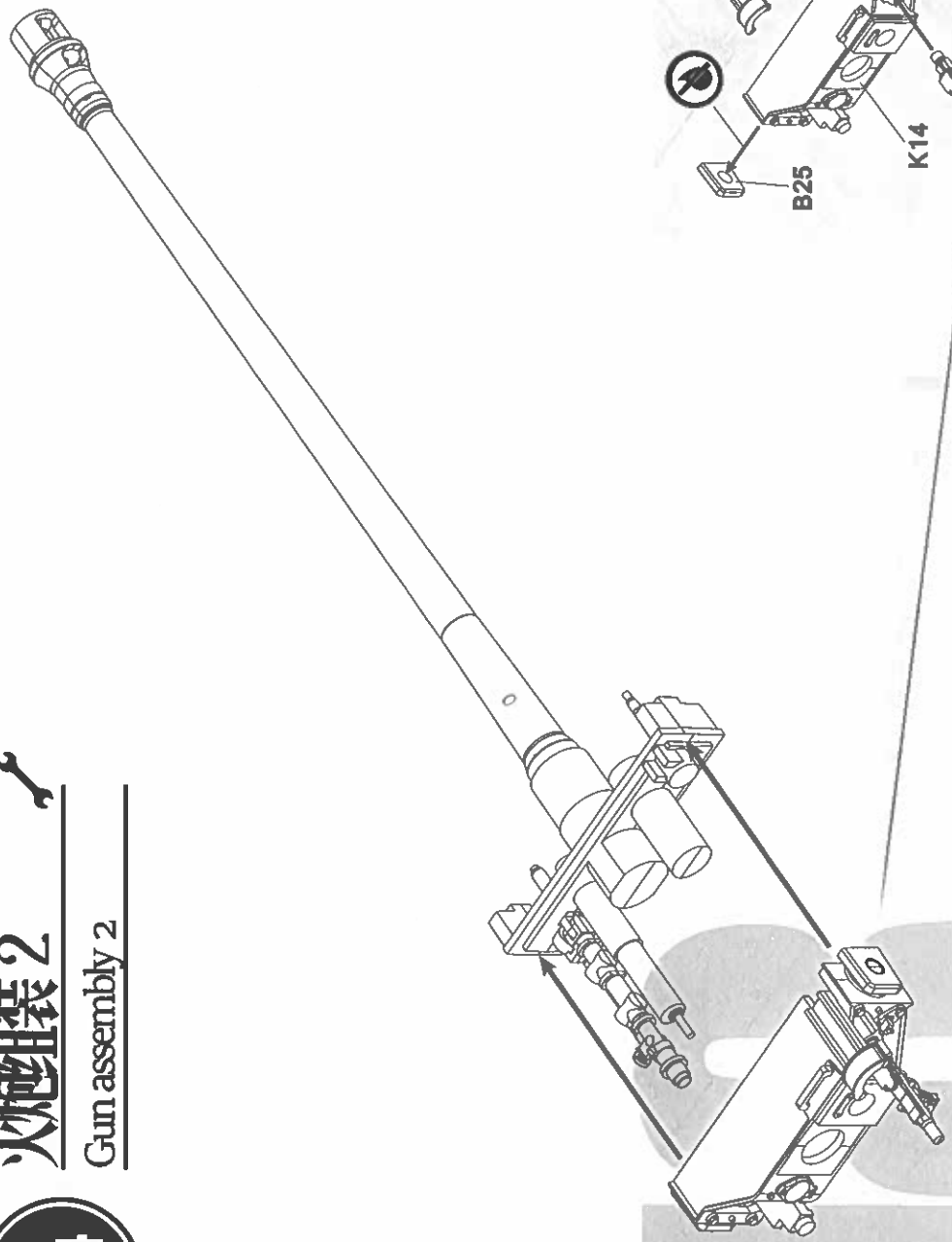



35

火炮組裝 3

Gun assembly 3

36

火炮組裝 4

Gun assembly 4

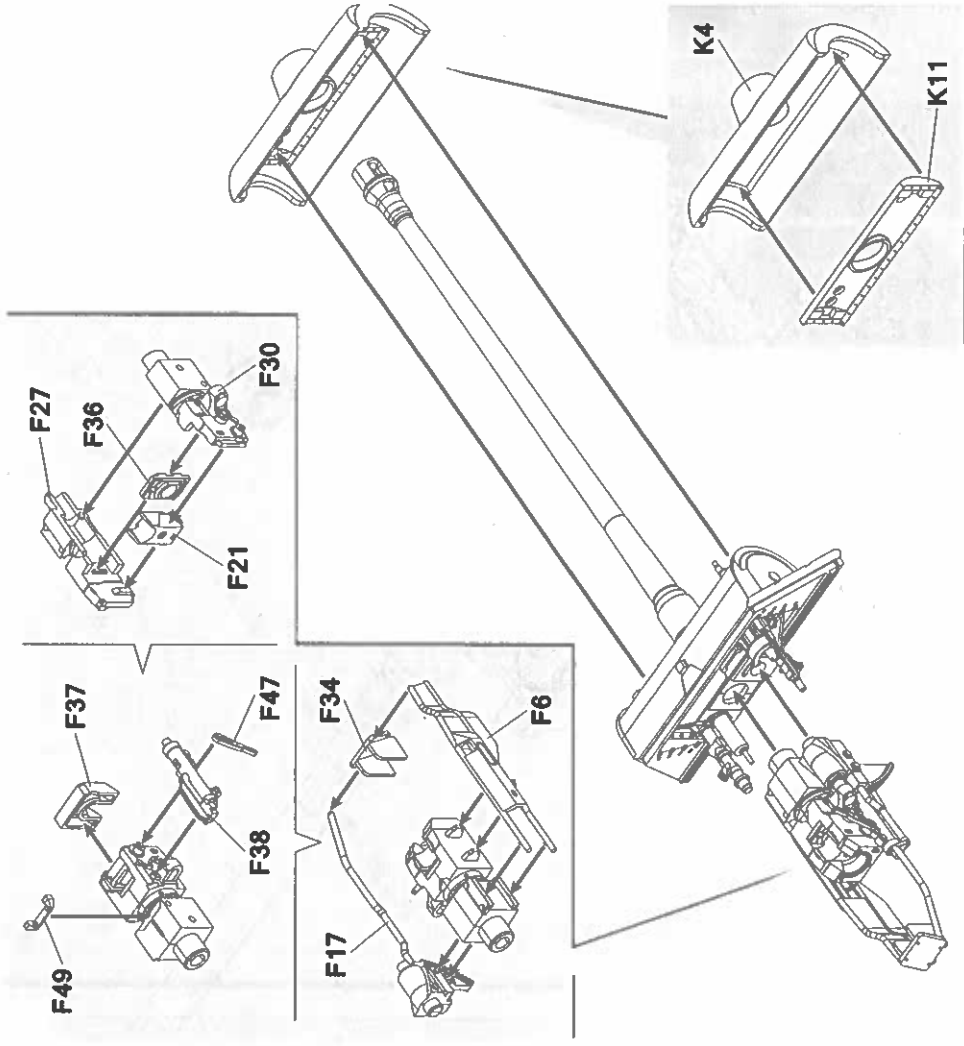
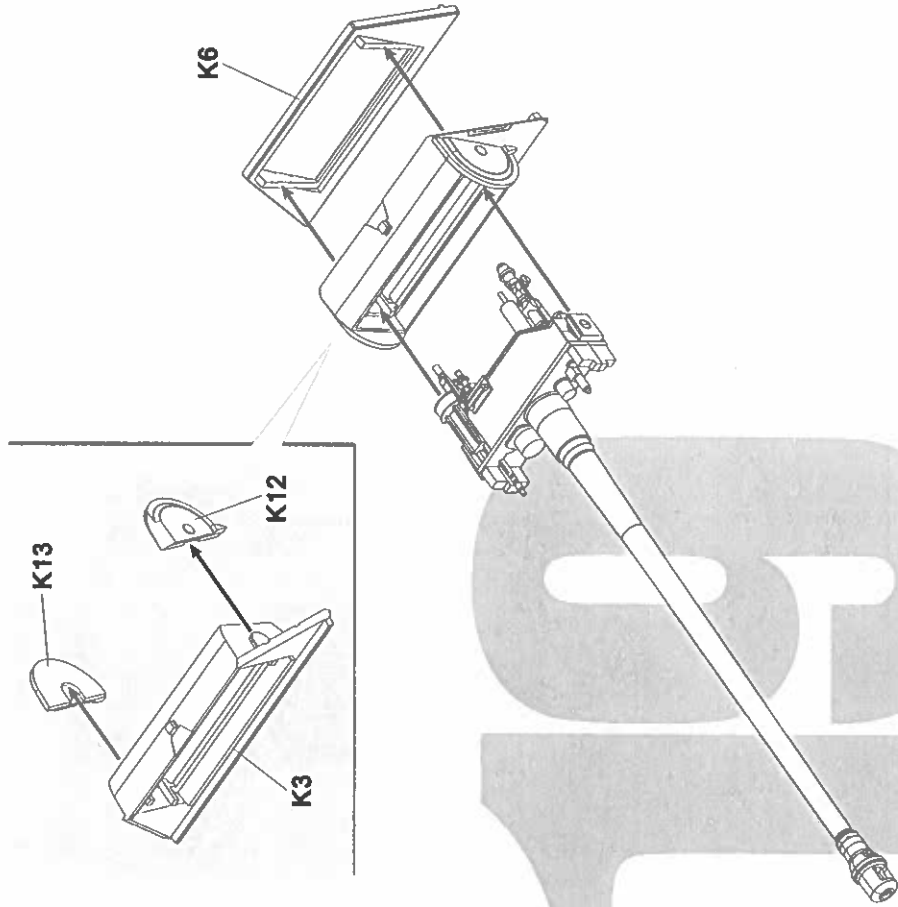



37

火炮组装 5

Gun assembly 5

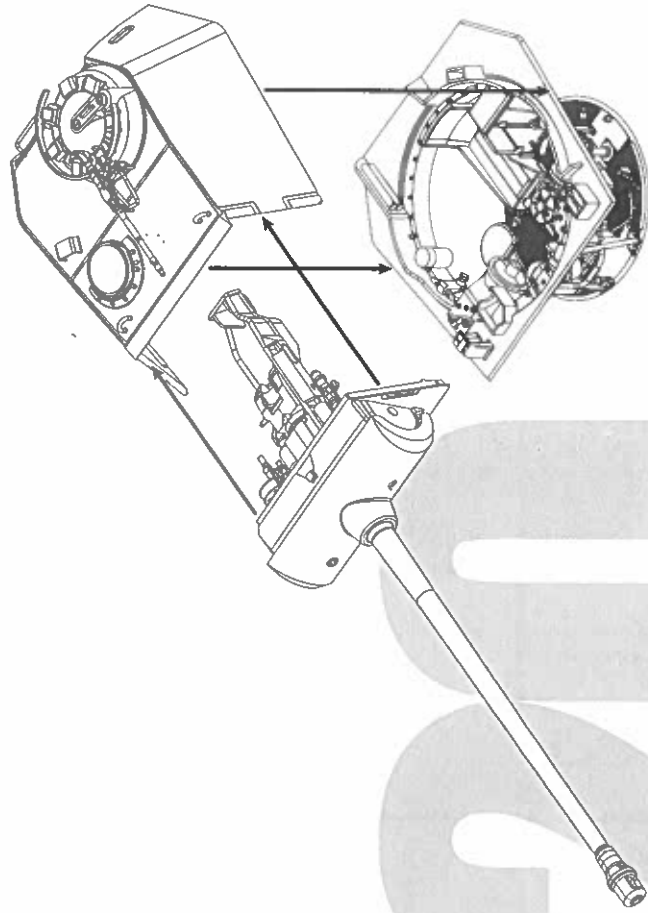

38

炮塔安装

Attaching turret

