

MILITARY MINIATURES SERIES

CROATIAN T-55A

37088



GENERAL INSTRUCTION

SCALE
1:35

- HIGHLY DETAILED MODEL
- WORCABLE TORSION BARS
- INDIVIDUAL TRACK LINKS INCLUDED
- PHOTO-ETCHED PARTS INCLUDED
- CLEAR PARTS INCLUDED
- ALL HATCHES CAN BE POSED OPEN & CLOSED
- DECAL SHEET FOR 6 MARKING OPTIONS

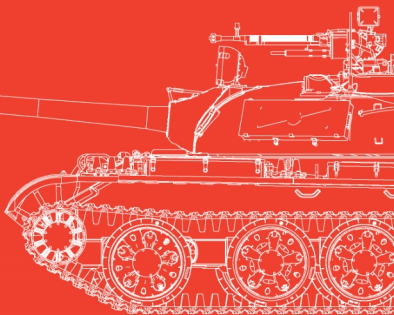

CROATIAN T-55A

SCALE
1:35

1st Guard Brigade "Tigrovi" (The Tigers)
Republic of Croatia Armed Forces, 1990's



CROATIAN T-55A

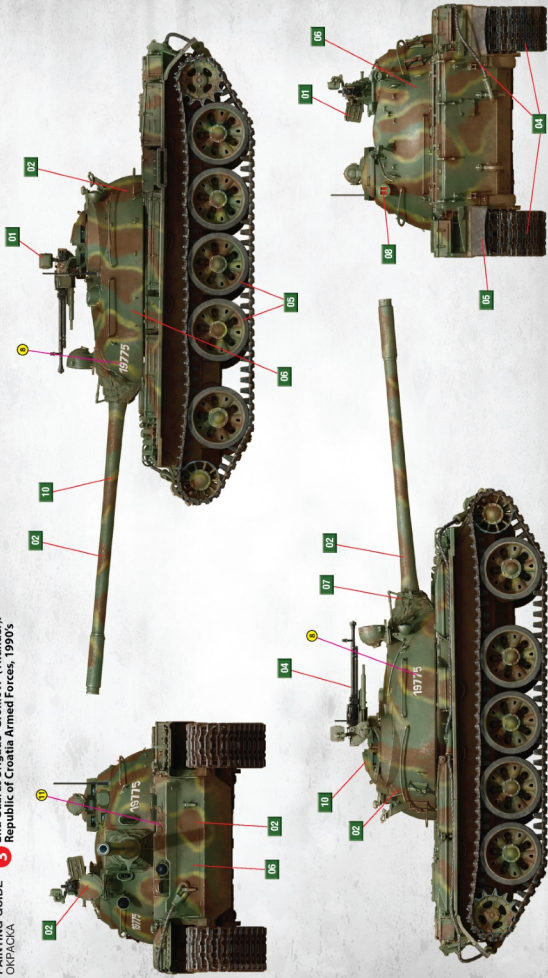

CROATIAN T-55A

SCALE
1:35

CROATIAN T-55A

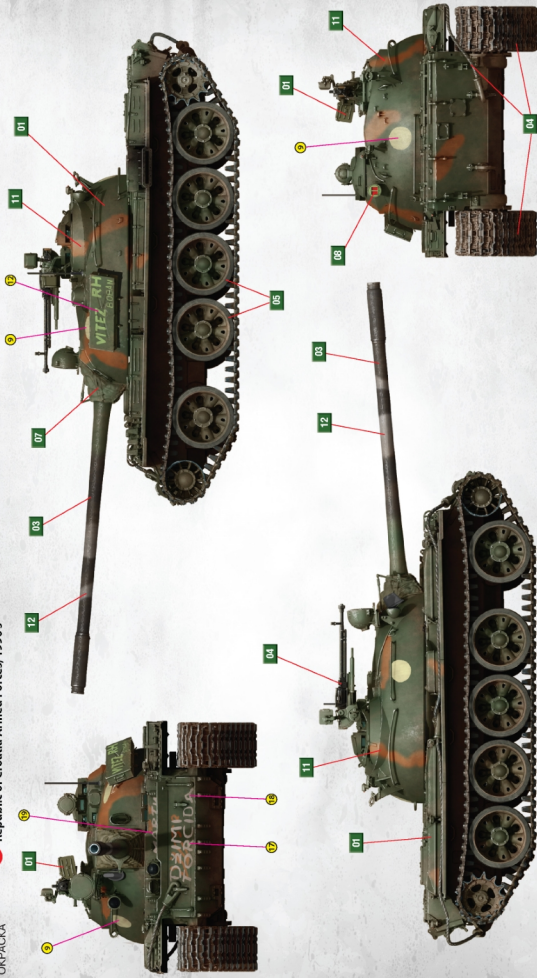

ATTENTION

Ne pas utiliser de colle ou de peinture à proximité d'une fenêtre nue, et éviter la pièce de temps en temps.
 Pour retirer les pièces hors du cadre, utiliser des ciseaux appropriés pour marquer la plastique en fonction avec un cutter ou une lime.
 Voir la fin de cette colonne pour la signification des symboles.
 Après l'assemblage peut rester des pièces inutilisées.

УВАГА

При використанні клею та фарби роботи проводите піддали від джерела волюю з приміщення, що добре провітрюється.
 Деталі відокремлювати від етикетки ножем або іншим гострим інструментом. Замість обробки виступаючі частини за допомогою надфайлу та наждачного паперу. Вудження моделі виконувати угідно з символами. Для зручності побудови кожну деталь позначена номером.
 Після складання можуть залишатися невикористані деталі.

ВНИМАНИЕ

При использовании клея и краски все работы проводить в проветриваемом помещении удален от источников огня.
 Детали отделять от этикетки ножом или другим острым инструментом. Вместо обработки выступающие части обрабатывать надфайлом и наждачной бумагой. Сборку модели производить согласно схеме сборки.
 Для удобства сборки каждая деталь обозначена номером.
 После сборки набора могут остаться неиспользованные детали.

ZUR BEACHTUNG

Kleber und Farbe nicht nahe von offenen Feuer verwenden und das Fenster von Zeit zu Zeit zur Belüftung öffnen.
 Zum Abschneiden der Teile vom Verbunddruck eine Modellerschere verwenden und die überstehenden Plastikteile mit einem Messer oder einer Feile beseitigen.
 Die Bedeutung der Symbole finden Sie unten in dieser Spalte.
 Nach dem Zusammenbau des Modells können einzelne Teile übrig bleiben.

ATTENZIONE

Non usare colla e vernice vicino a fiamme scoperte, e aprire le finestre di tanto in tanto per cambiare l'aria.
 Quando si staccano parti del cartello, usare forbici da modellismo e eliminare le plastiche in eccesso con un coltello o una lima. Vedere in fondo a questa colonna per il significato dei simboli.
 Dopo l'assemblaggio possono rimanere parti inutilizzate.

CAUTION

When you use glue or paint, do not use near open flame, and use in well ventilated room.
 When you take parts off from the runner frame, use modeling scissors or cutter.
 See the bottom of this column for the meaning of symbols.
 Extra details can remain after assembling of the kit.

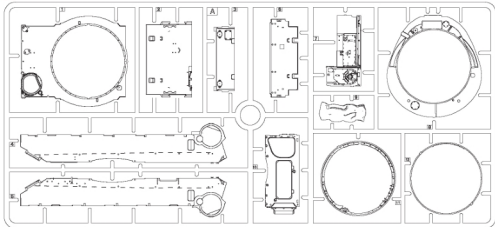
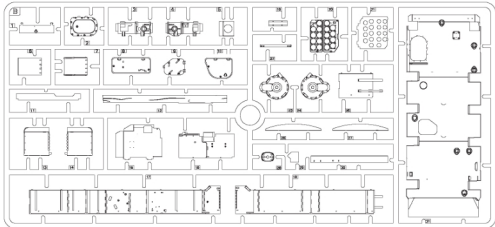
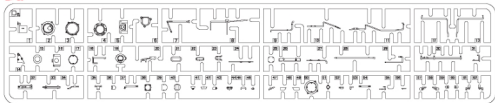
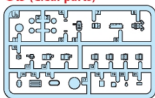
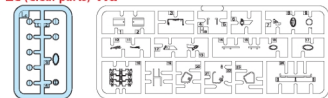
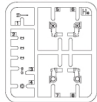
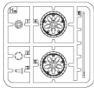
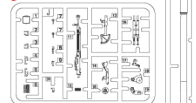
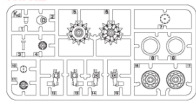
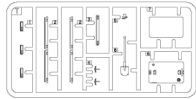
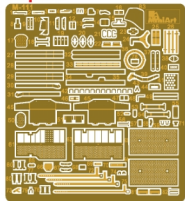
PARTS**A****B****Da****Decal****Ub (Clear parts)****Lc (Clear parts) Ha****Ho x4****Hm x8****J****Ga****Kd x2****T x2****PE parts**



MADE FROM
2 TEILE FERTIGEN
FERTIGEN 2 PEZES
FARE DUE PEZZI
TWO PIECES
DÖR 2 ST
FERTIGFÖRTE 2 DELA PÅSÅ
BILAGSITÄT PÅSÅ



DO NOT CELENT
NÖCHT KLEBEN
NE PAS COLLER
NON INCOLLARE
EVA
LIMAJLI
NE KLEBITE
NE KLEBITI



OPTIONAL
NÄCH BELIEBEN
FACILITÄTIN
FACILITÄTIVO
VALIKOMMUNEN
VALIKAR
BALKANITÄT
BALKANITÄT



OPEN HALF
ÖPPEN
FARE UN TRUO
FORO APERTO
FORO APERTO
OPPIA HALET
QIETVAI DITRUPTE
SPROSTIN ÖPPE



REMOVE
ENTFERNEN
RETRIER
SEPARARE
ROVETI
ALLAGINA
ÖFFNEN
BIRKATIN



SEND
SITTS BESEN
PLIER SIL YOUR PLANT
PIEGARE
PIEGARE
SITTA
SOCCA
SITITITÄT
SITITITÄT



SCRATCH BUILD
AM REISTEN ZU MACHEN
FAIRE LE PLUS
RENCITI
TELE TIRE
ÖÖR DÖR SÄULY
QIETVAI DITRUPTE
SPROSTIN GÄRÖP

PARTS

Db

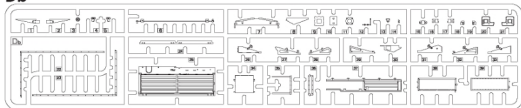

Fb

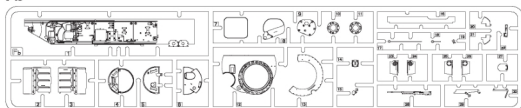

S

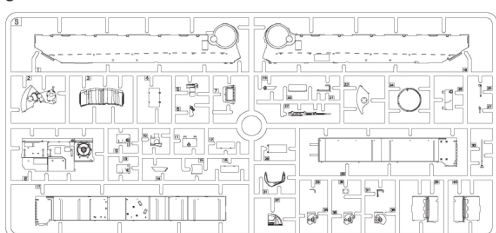

J1

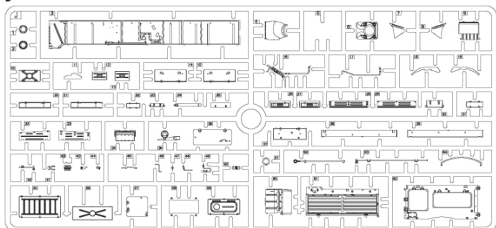

Ue

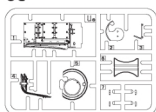

We x3



Wj x2



Td x3

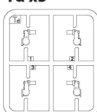

Ld

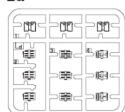

Hf x10

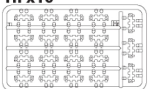

Hj x3



Ta x2

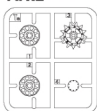

Gd

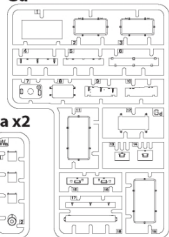

Wa x2



Tc x3

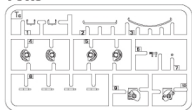

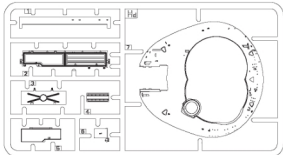
Hd¹

Hc

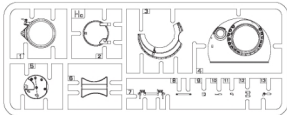

Wi x4

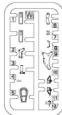

Lb

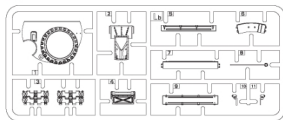

Pa

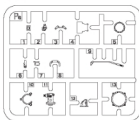

Hd x4



Lf x2

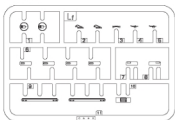

Le x2

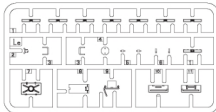

Lg

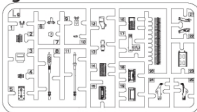
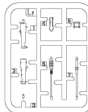
Lf¹

Wh x2

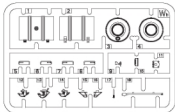

INSTRUCTION

1

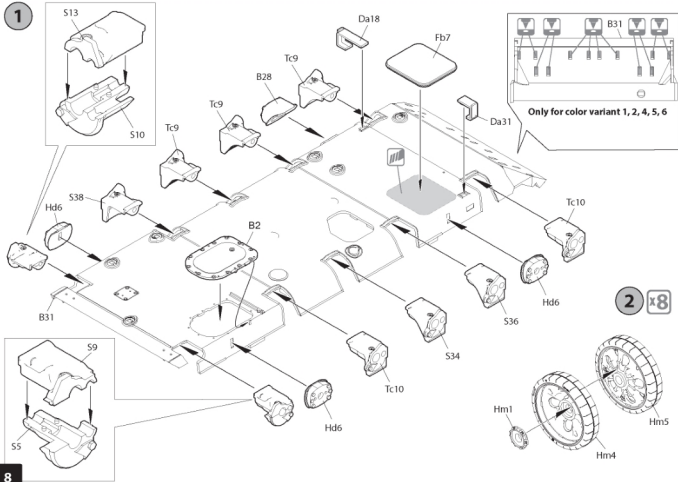

8

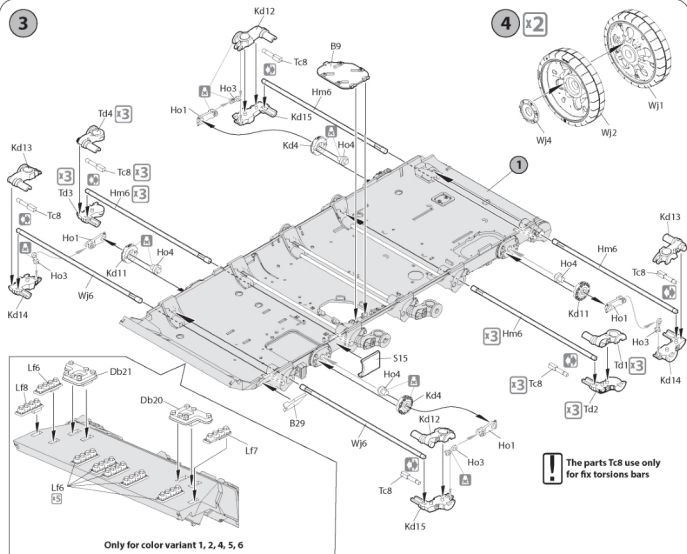
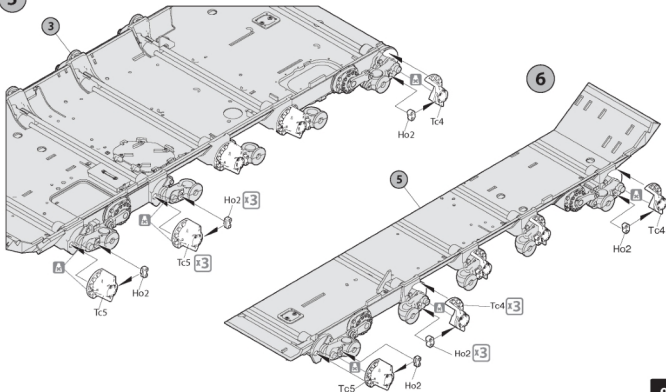
3**5**

7

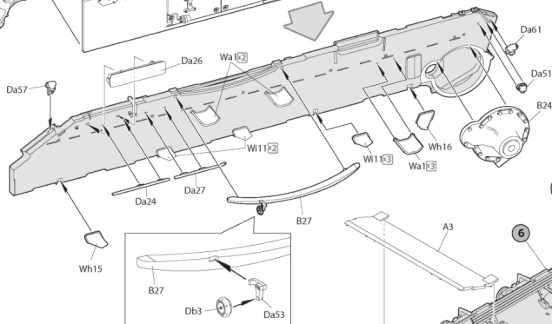
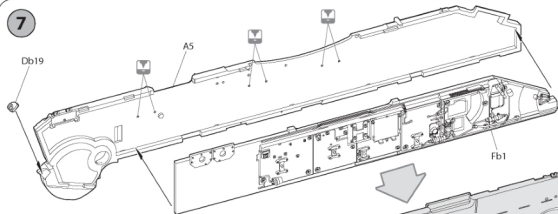

8

9

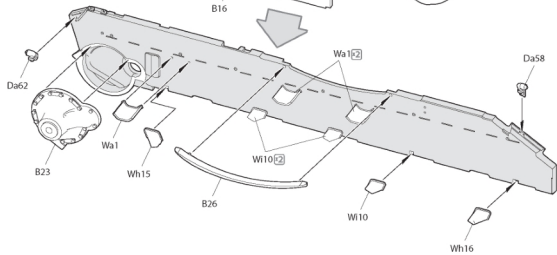
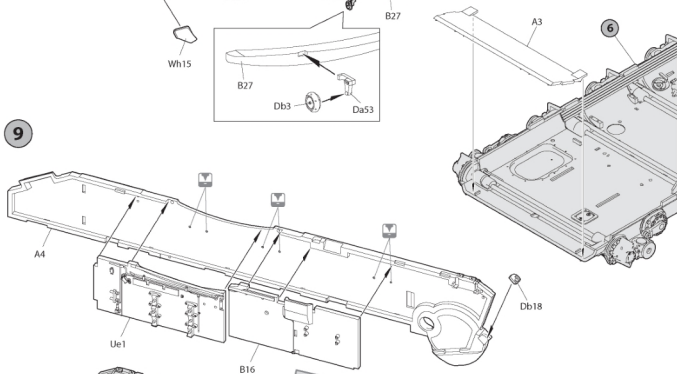

10

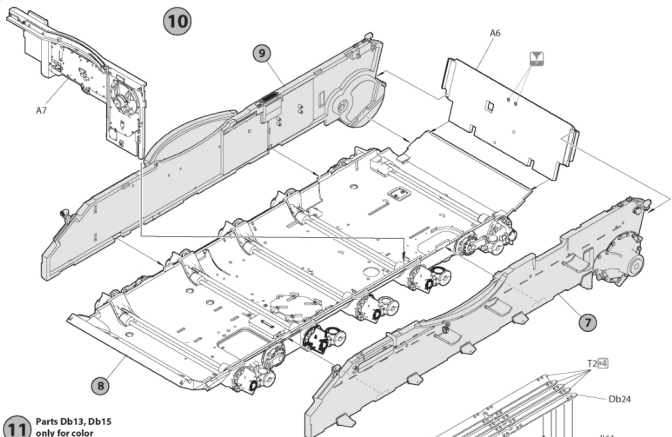

11 Parts Db13, Db15 only for color variant 1, 2, 4, 5, 6

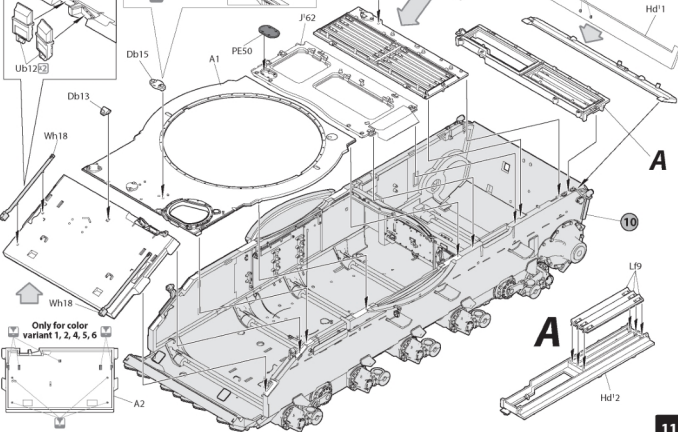
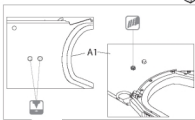
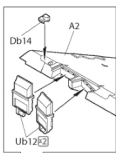

Only for color variant 1, 2, 4, 5, 6



12

A

B

13

C

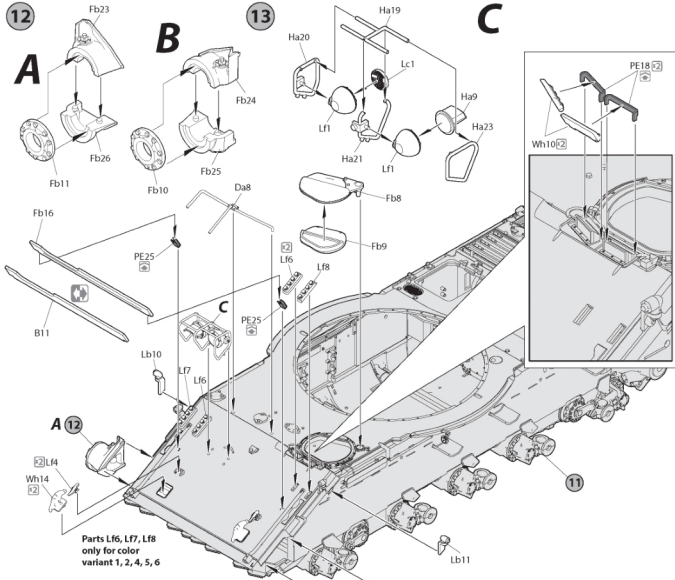

Parts Lf6, Lf7, Lf8
only for color
variant 1, 2, 4, 5, 6

14

B

13

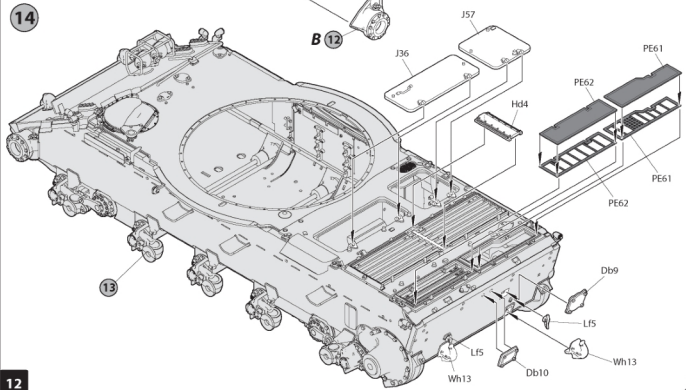

15

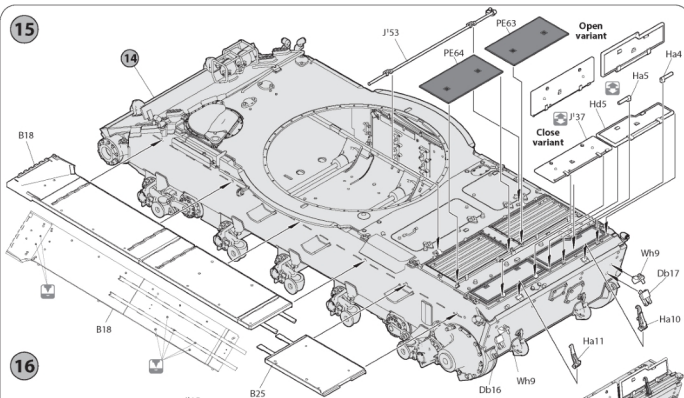

16

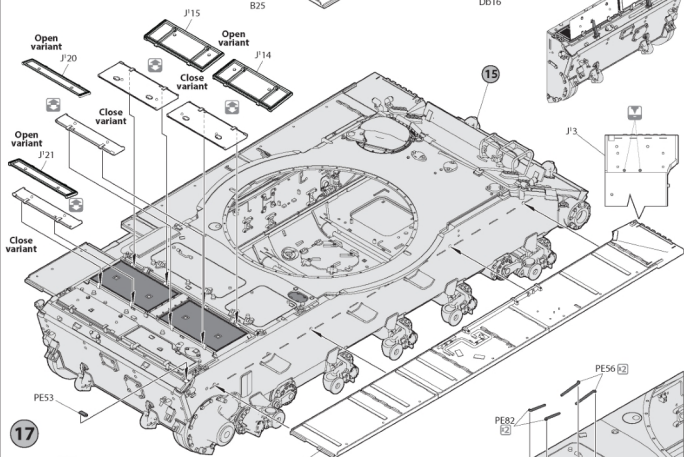

17

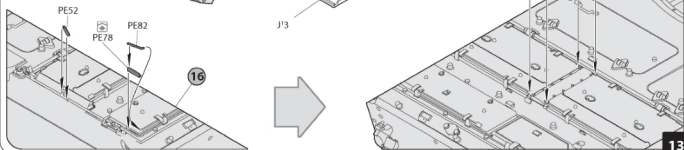

13

18

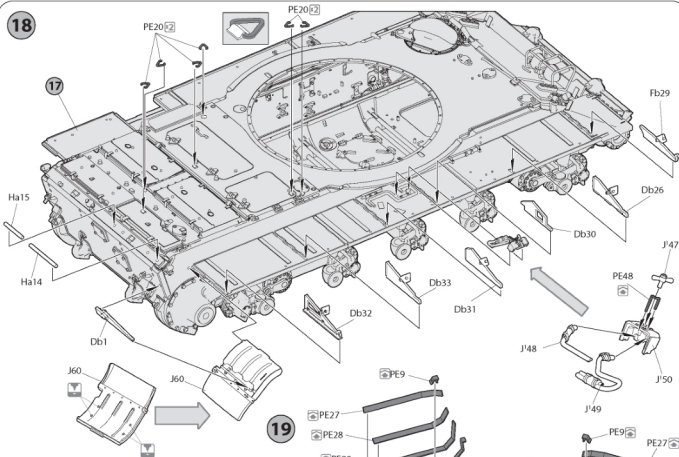

19

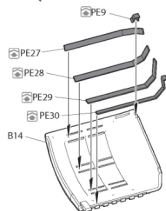

20

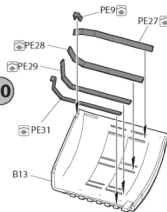

21

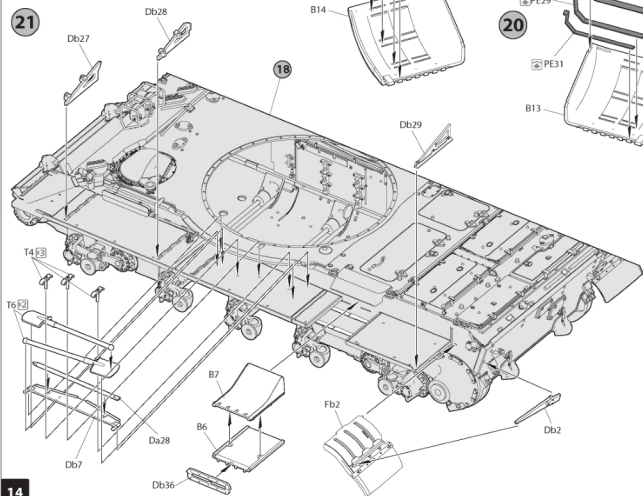

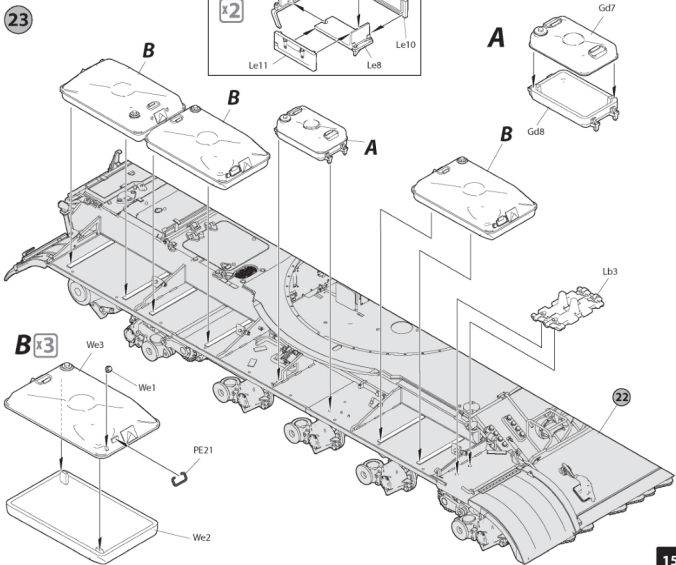
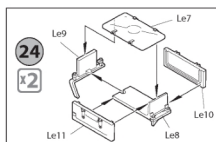
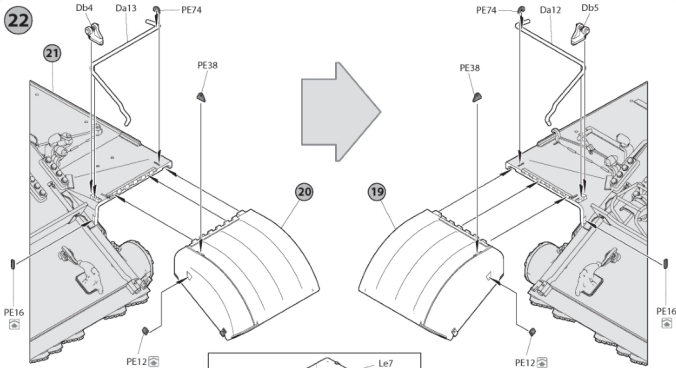

25

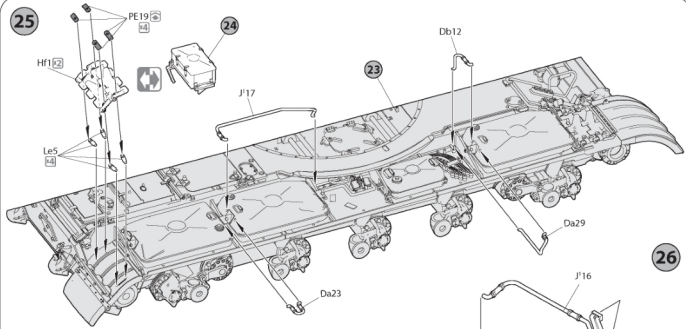

26

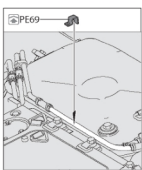

25

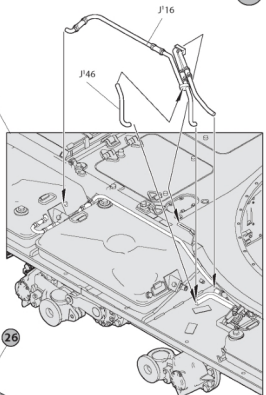

27

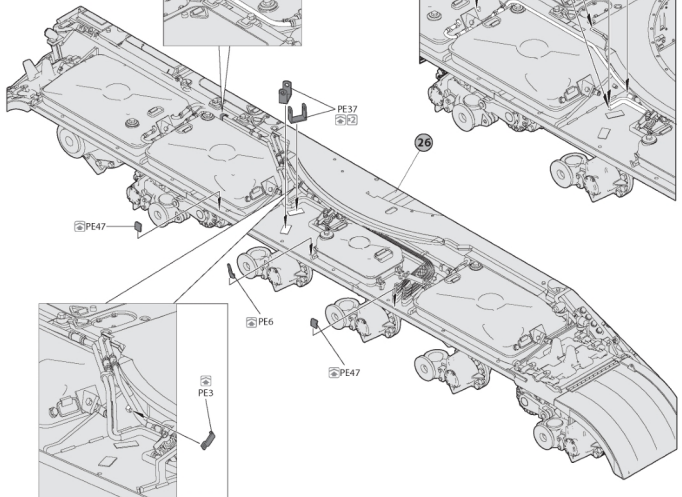

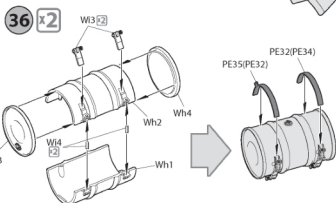
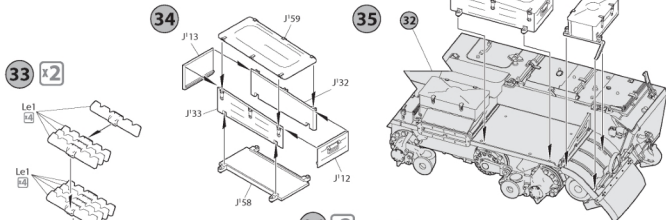
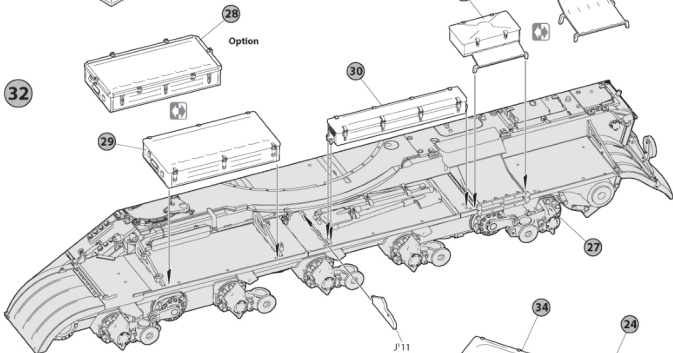
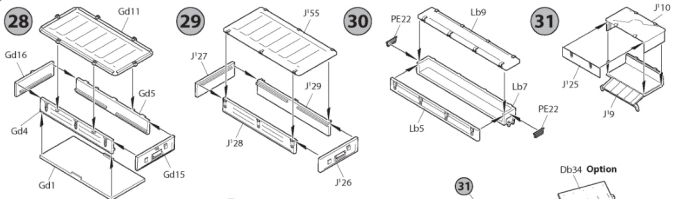

37

33

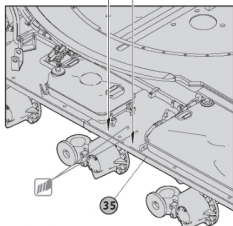

35



Option

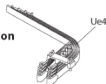

35

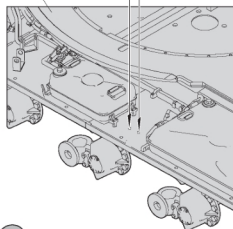

38

Only for color variant 1, 5, 6



33

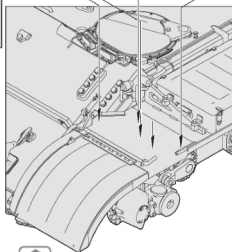

37



Only for color variant 2, 3, 4

Ha18

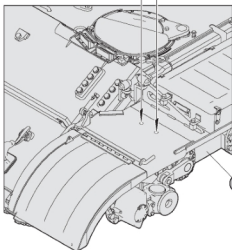

37

39

Ha3

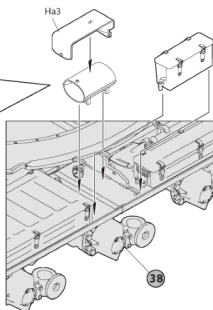
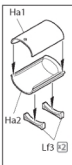

38

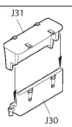

Lb3

Option

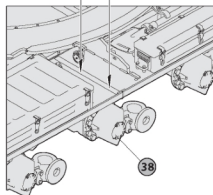

38

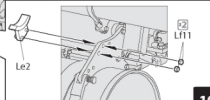
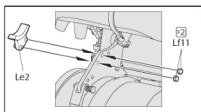
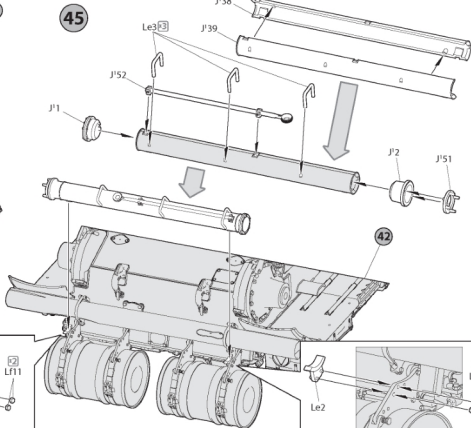
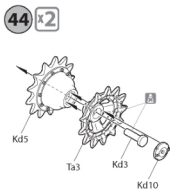
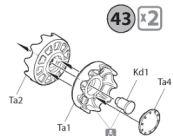
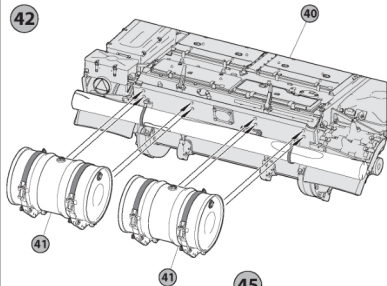
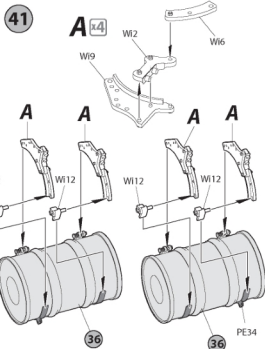
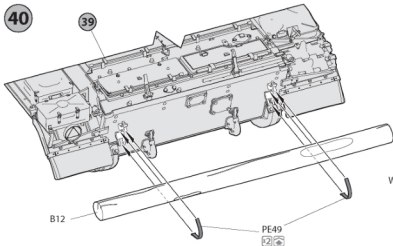

46 $\times 2$ Repeat on the reverse side

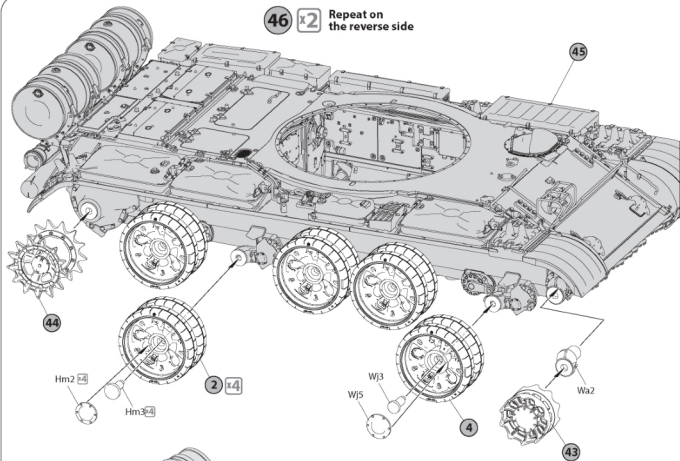

47 $\times 2$ Repeat on the reverse side

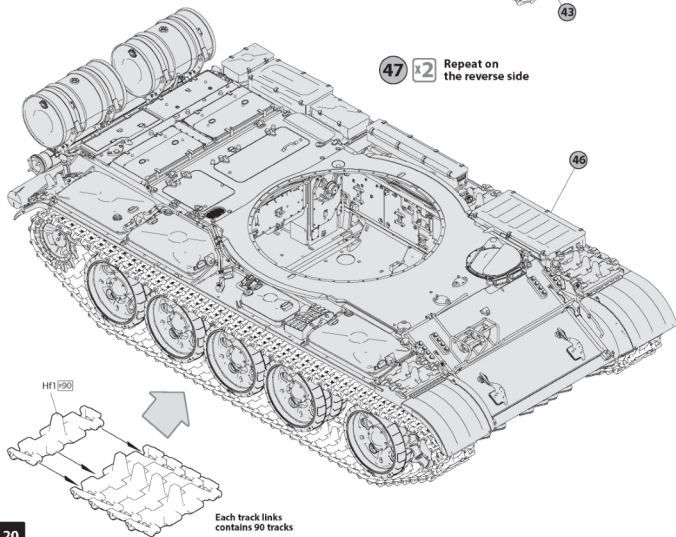

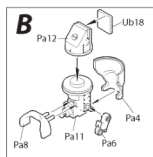
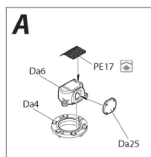
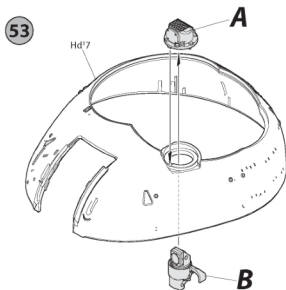
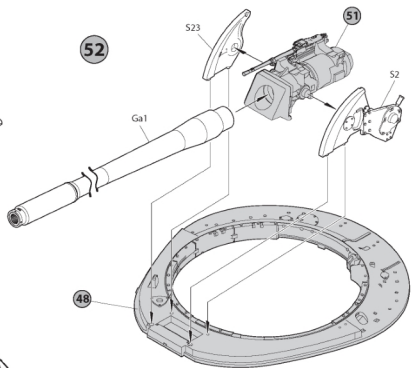
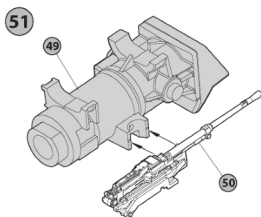
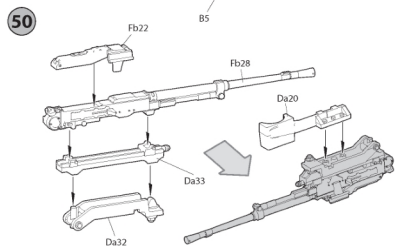
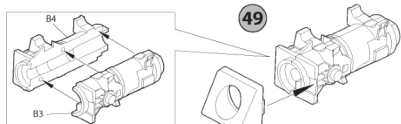
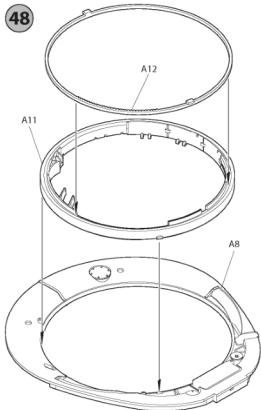

54

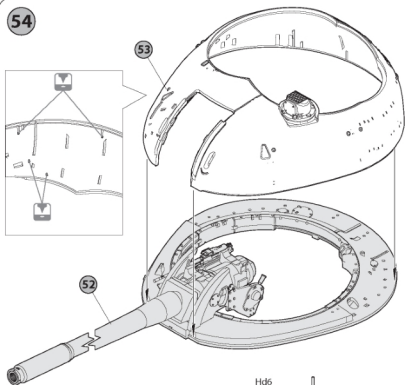

55

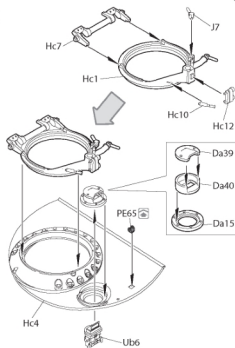

56

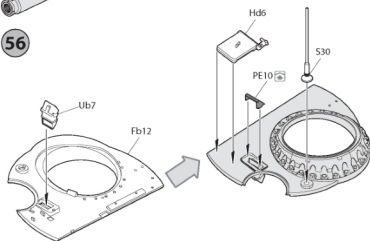

57

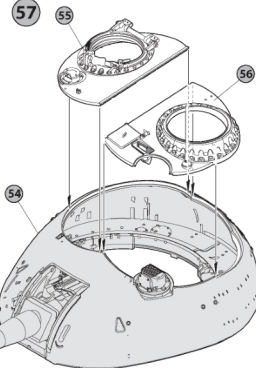

58

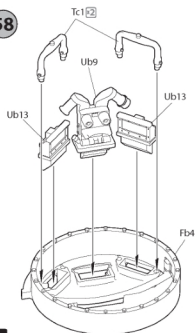

59

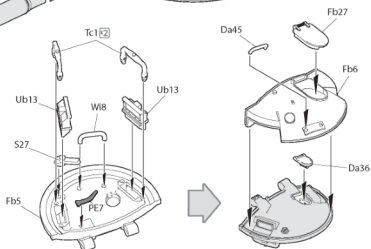

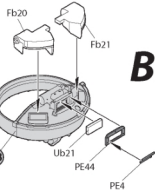
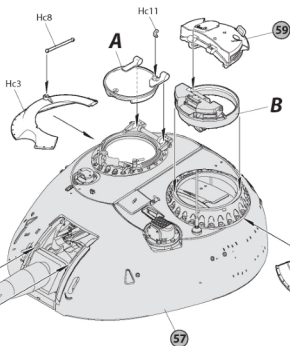
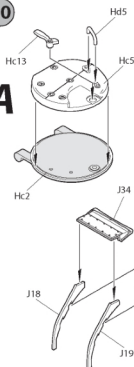
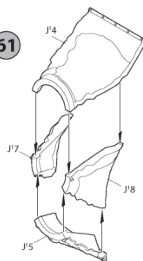
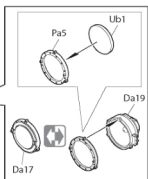
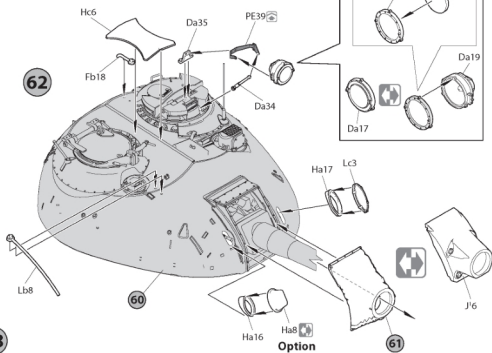
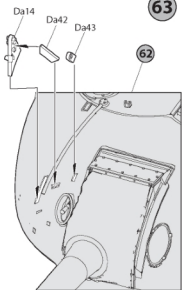
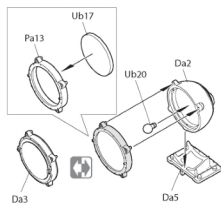
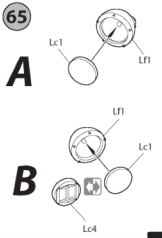
60**A****B****61****62****63****64****65****A****B**

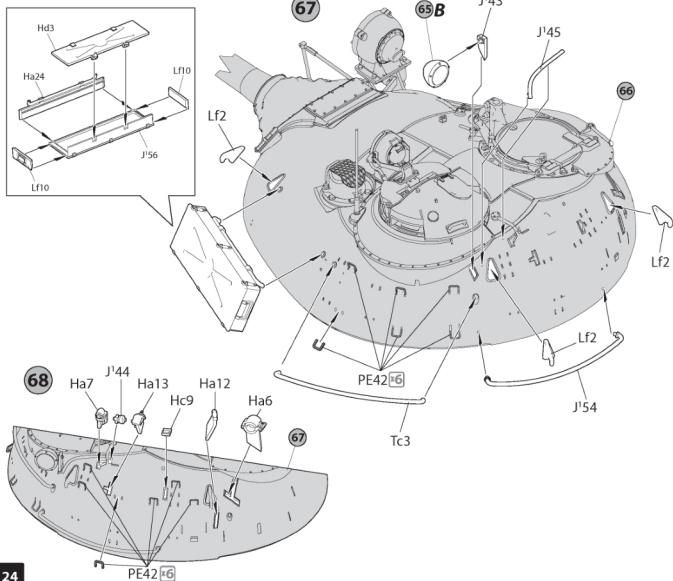
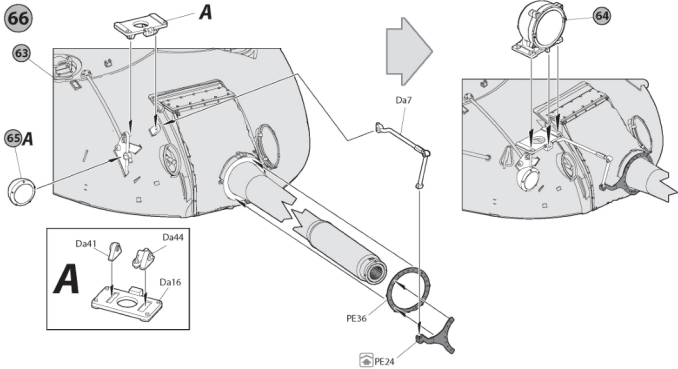

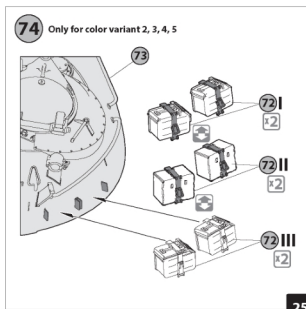
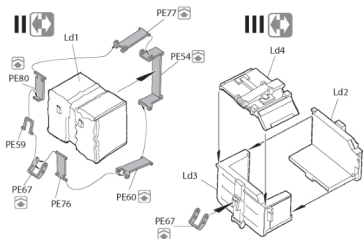
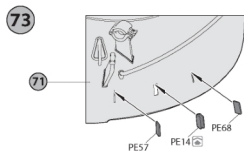
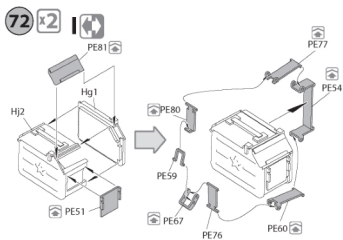
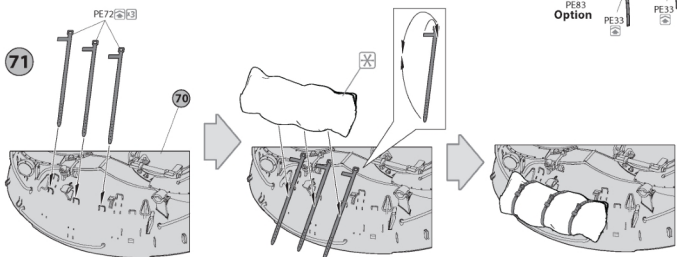
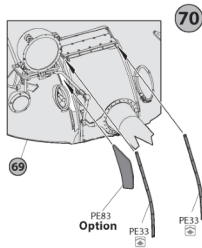
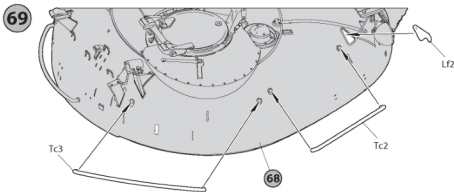

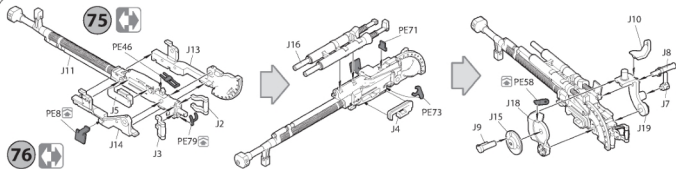

76

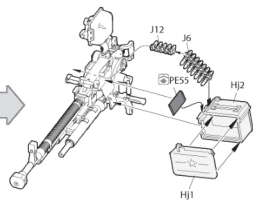
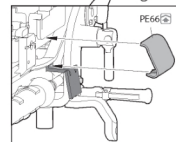
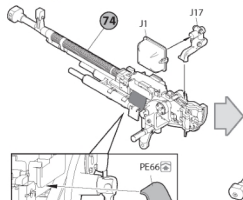

**Step 75, 76
only for color
variant 2, 3, 4, 5**

77 Only for color variant 1, 6

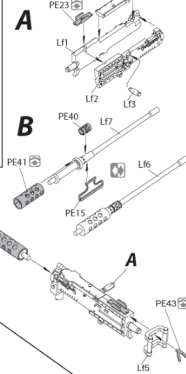

78 Only for color variant 1

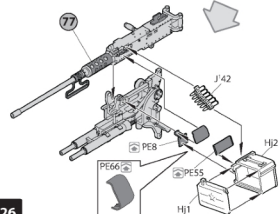
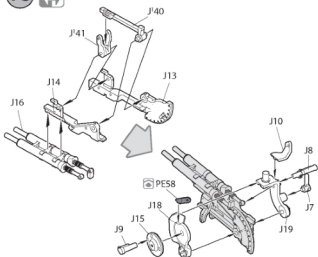

79 Only for color variant 6

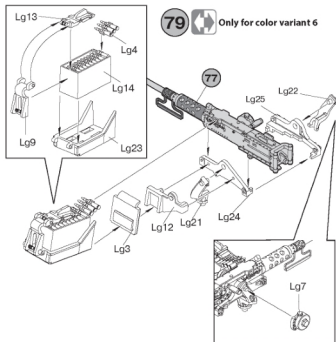

80

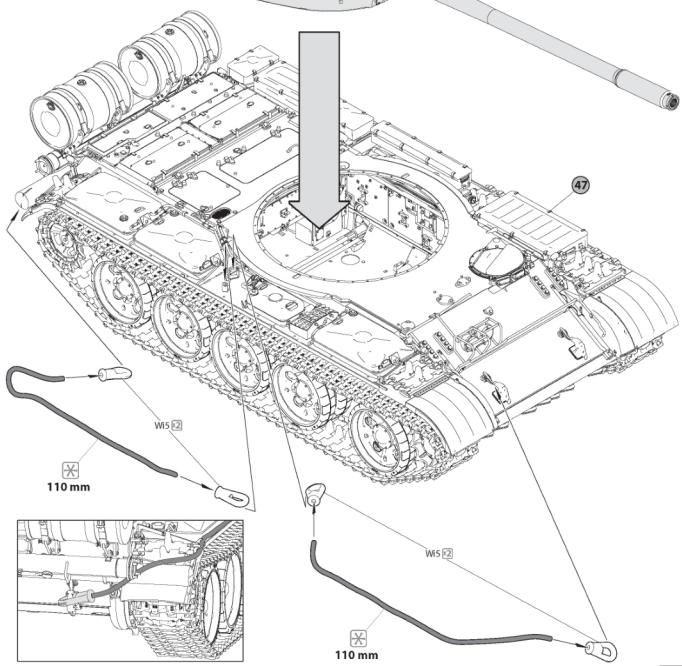
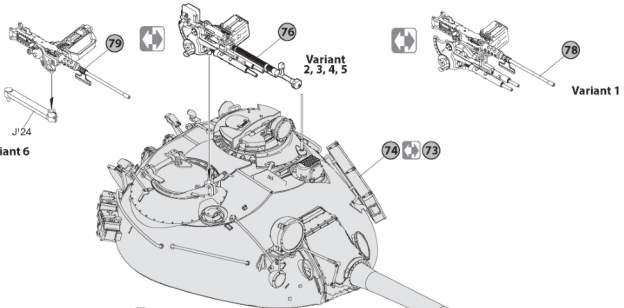

81

A

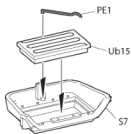

B

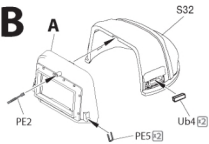

C

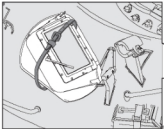
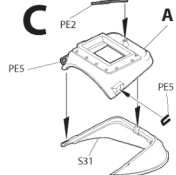

82

C



81 B

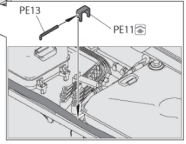
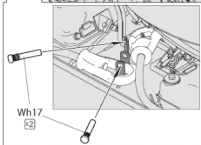
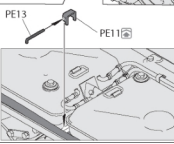
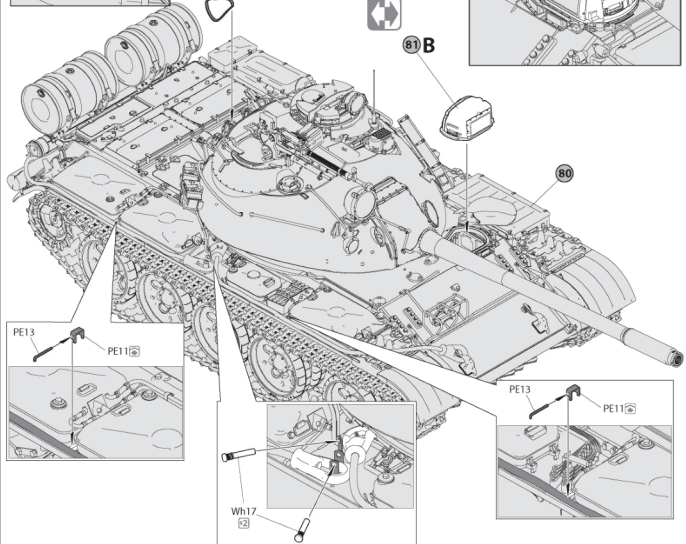
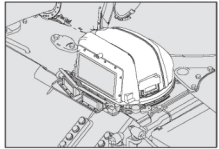

COLOR CHART

#P	Color	Vallejo	Mt. Color	AK RC	Mission Models	AMMO MIG	Tamiya	Color name
01		71.017	C-136	RC-073	MMP-029	A.MIG-0083	XF-45	Russian Green
02		71.040	C-310	RC-035	MMP-033	A.MIG-0076	XF-72	Brown
03		71.057	C-033	RC-001	MMP-047	A.MIG-0046	XF-01	Black
04		71.073	C-078	RC-015	MMIM-001	A.MIG-0045	XF-84	Gun Metal
05		71.315	C-137	RC-022	MMP-040	A.MIG-0032	XF-85	Tire Black
06		71.095	C-136	RC-047	MMP-009	A.MIG-0060	XF-05	Green
07		71.016	C-039	RC-024	MMP-020	A.MIG-0056	XF-60	Khaki
08		71.003	C-003	RC-006	MMP-003	A.MIG-0049	XF-47	Red
09		71.094	C-038	RC-023	MMP-025	A.MIG-0238	XF-58	Olive Green
10		71.106	C-039	RC-075	MMP-086	A.MIG-0222	XF-59	Sand
11		71.034	C-043	RC-031	MMP-027	A.MIG-0064	XF-52	Sand Brown
12		70.992	013	RC-240	MMP-072	A.MIG-0050	XF-75	Grey
13		71.015	017	RC-275	MMP-077	A.MIG-0233	XF-73	Dark Green

CROATIAN T-55A

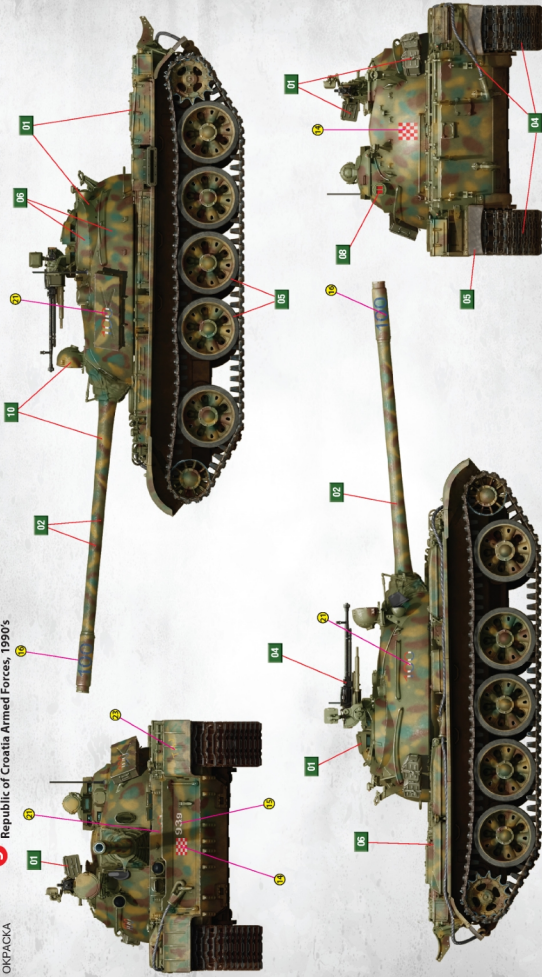

CROATIAN T-55A



RELATED ITEMS



RELATED ITEMS

