

SKY MODELS

SKY MODELS
VIA DEI VELIPRI 142
00121 - ROME ITALY
PH. & FAX 0039 61 5674110
E-MAIL: skymodels@ruscalinet.it
VISIT OUR WEB SITE:
web:ruscalinet/skymodels

MACCHI MC 205 1/72 ND SCALE 72 - 034

GLI SCHEMI MIMETICI SONO RIFERITI AL LIBRO: CAMOUFLAGE SCHEMES ARE REFERED AT THE BOOK: "COLORI E SCHEMI MIMETICI DELLA REGIA AERONAUTICA 1939-1943 DI POSTIGLIONI & DEGL'INNOCENTI DEL GMT.CMPR.GAVS.

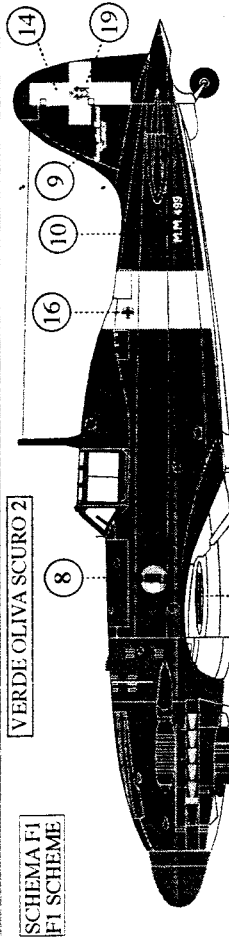

SCHEMA F1
F1 SCHEME

VERDE OLIVA SCURO 2

GRIGIO AZZURRO CHIARO 1

Macchi MC 205N - MM.499 Prototipo, Lonate Pozzolo

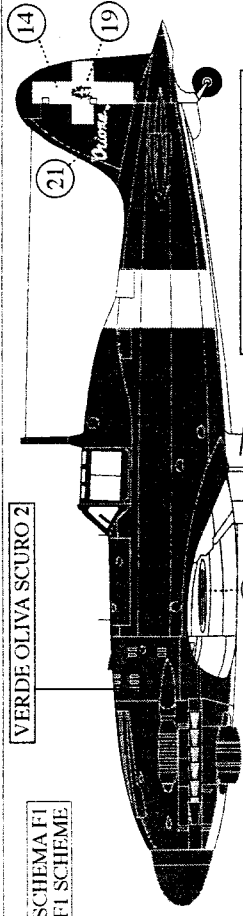

SCHEMA F1
F1 SCHEME

VERDE OLIVA SCURO 2

GRIGIO AZZURRO CHIARO 1

Macchi MC 205N - MM.500 2° Prototipo

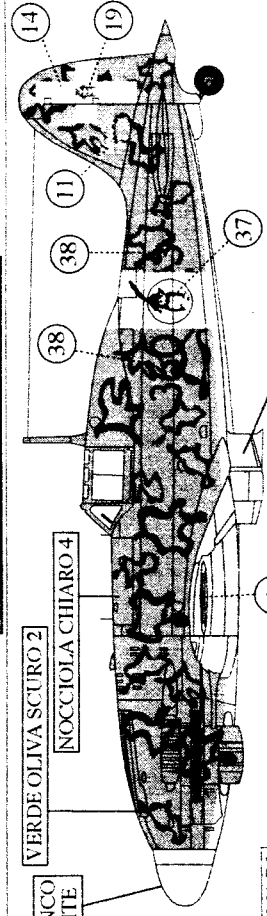

SCHEMA D3
D3 SCHEME

BIANCO
WHITE

VERDE OLIVA SCURO 2

NOCCIOLA CHIARO 4

Macchi MC 205 - MM.9291 - 360°Sq.155° Gr.51°St.Sardinia, summer 1943

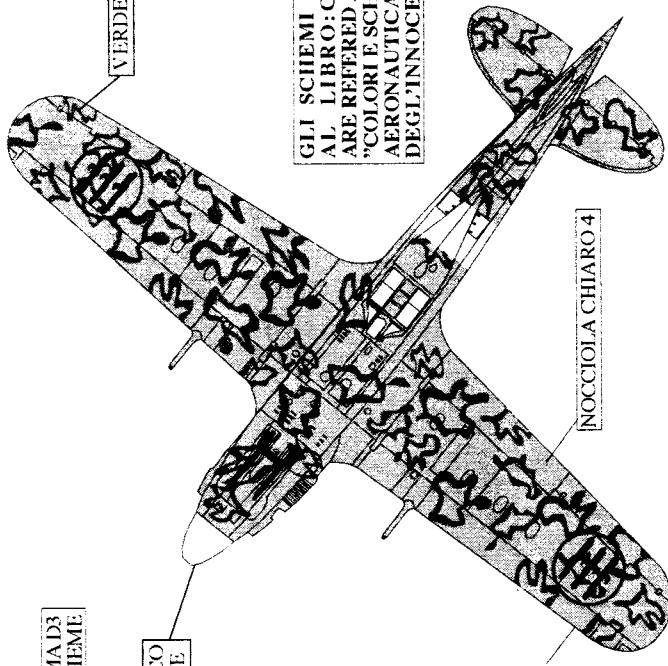

SCHEMA D3
D3 SCHEME

BIANCO
WHITE

VERDE OLIVA SCURO 2

NOCCIOLA CHIARO 4

GLI SCHEMI MIMETICI SONO RIFERITI AL LIBRO: CAMOUFLAGE SCHEMES ARE REFERED AT THE BOOK: "COLORI E SCHEMI MIMETICI DELLA REGIA AERONAUTICA 1939-1943 DI POSTIGLIONI & DEGL'INNOCENTI DEL GMT.CMPR.GAVS.

SOURCES

COLORI E SCHEMI MIMETICI DELLA REGIA AERONAUTICA, C.M.P.R., G.A.V.S., G.M.T.;
- SCHEMI E COLORI MIMETICI DELL'AERONAUTICA MILITARE ITALIANA, serie le macchine e la storia n° 4, di N.Arena & G.Pini, Stem nacchi editore;- DIMENSIONE CIELO N° , caccia assalto;- REGIA AERONAUTICA: voli; colori e insegne; il settore mediterraneo, di Emiliani, ghergo & Vigna, Intergest editore, 1975-1976;- COURAGE ALONE, C.Dunning, Hikoki publications;- AIR WAR ITALY, Beale, d'Amico & valentini, Airfile publications;- STORIA MILITARE, numeri vari;- AEROPAN, numeri vari;- STORIA MODELISMO, numeri vari;- AEREI MODELISMO, numeri vari;- L'AERONAUTICA NAZIONALE REPUBBLICANA, di N.Arena, Ermanno Albertelli Editore;-

COLOUR GUIDE

COLOUR	FS 595 B	HUMBROL	MOLAK	TAMIYA	GUNZE	MODEL M	MRKIT
MARRONE MIMETICO 1	30118	142 F	11M	XF 52	22 SG	1702	012
MARRONE MIMETICO 2	30109	+180 F	13 M		81 G	+1785	014
MARRONE 53193	30140	+119	30140		+43 G		013
BRUNO MIMETICO	30227	+187 F	+30219 F		+310	+1567 F	015
GIALLO MIMETICO 2	33481	81 F	33481	+XF 54	27 SG	+1584	009
GIALLO MIMETICO 1	33594	47 G	LMU 25 F		+44 G		008
GIALLO MIMETICO 3	33434		33434		+95 G		010
GIALLO MIMETICO 4	30266	+94 F	+L B12 F		21 SG		011
VERDE MIMETICO 1	34258		34258				004
VERDE MIMETICO 2	34092	8 149 F		+XF 11	302 SG	1764 F	005
VERDE MIMETICO 3	34102	86 F	34102	+XF 58	303 SG	1713 F	006
VERDE MIM.53192	34227	+120 F	34227		312SG	1716 F	007
GRIGIO MIMETICO	36231	140 F	36231 F		317 SG	1740 F	021
GRIGIO AZZ. CHIARO 1	36307	141 F	36307	+XF 19	+334 SG	1726 F	020
VERDE OLIVASC.2	34052			XF 52 F	18 SG		003
GRIGIO AZZ. SC.3	36118	125 SG		+L J 1 F	305 SG	1723 F	019
NOCCIOLA CHIARO 4	30219	118 F	30219 F		310 SG	1742 F	016
GIALLO CROMO 7	33455	69 G	6 G	X 8 G	+4 G		
ROSSO 8	31105	+19 G	+4 G	X 7 G	3 G	+1503 G	017

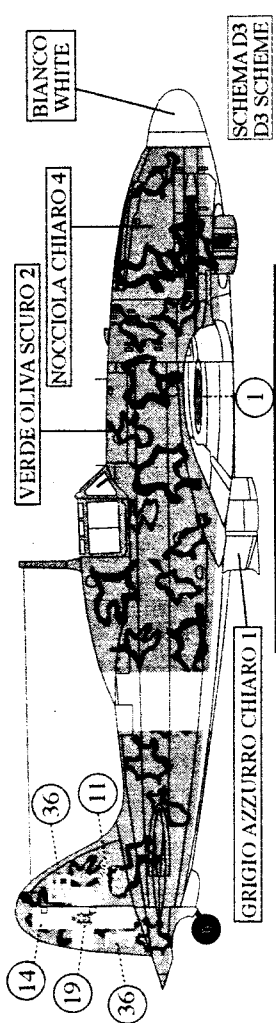

Macchi MC 205 - 85^a Sq. 18^o Gr. 3^o Sl. 1943

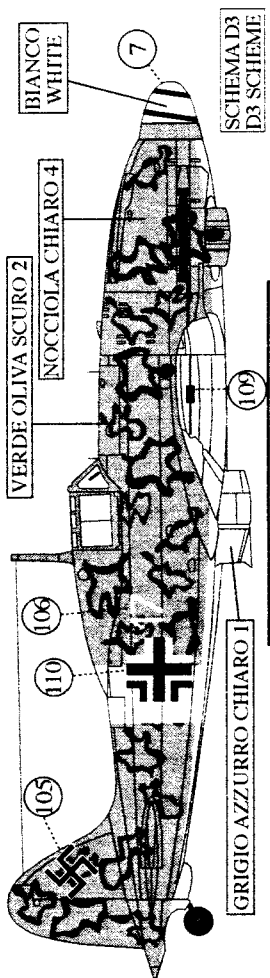

Macchi MC 205 - 85^a Sq. 18^o Gr. 3^o Sl. 1943

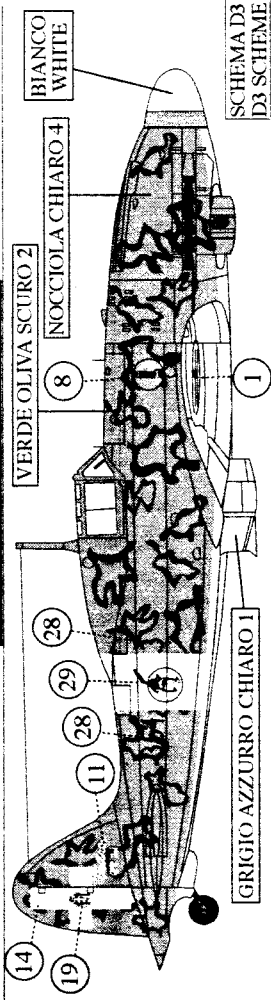

Macchi MC 205 - 351^a Sq. 51^o St. - Sardinia, summer 1943

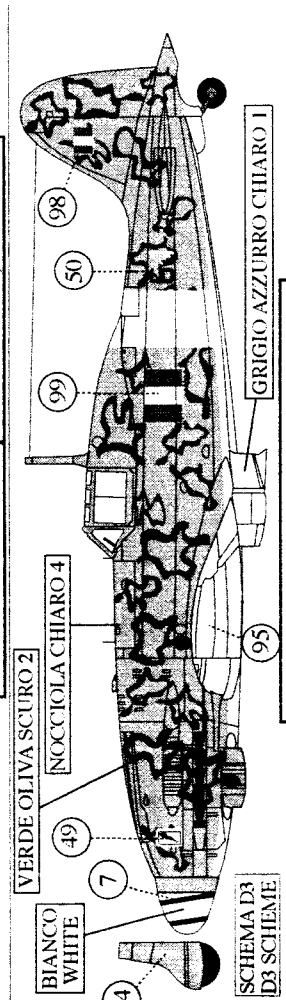

Macchi MC 205 V - 1^a Sq. 1^o Gr. Caccia ANR

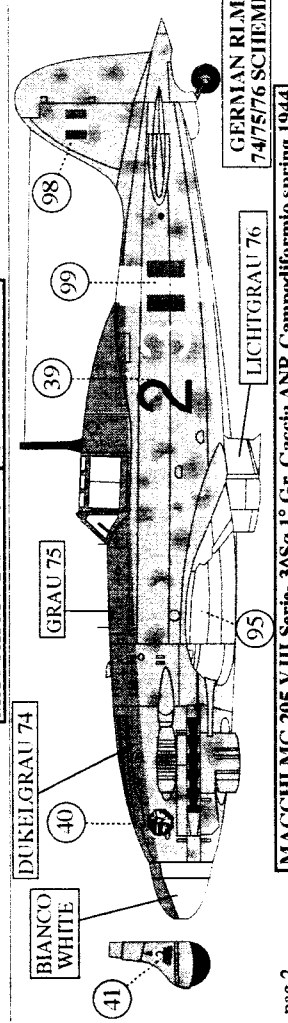

Macchi MC 205 V III Serie - 3^a Sq. 1^o Gr. Caccia ANR, Campediformio, spring 1944

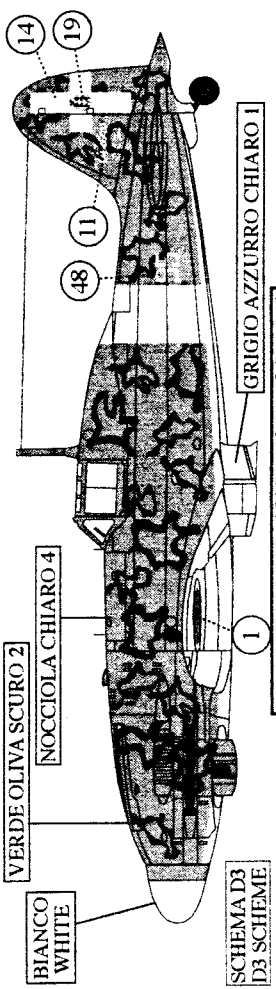

Macchi MC 205 - 95^a Sq. 18^o Gr. 3^o Sl. 1943

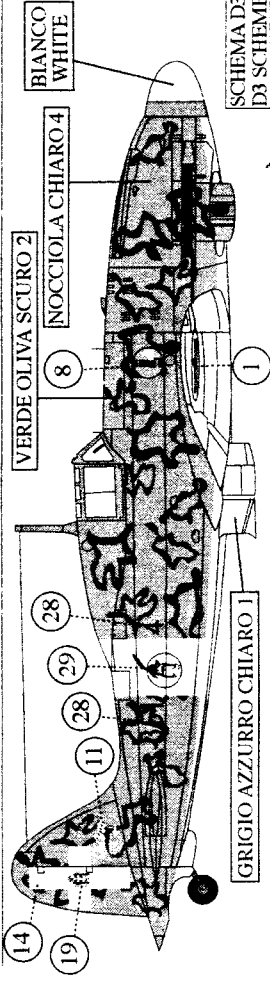

Macchi MC 205 - 351^a Sq. 51^o St. - Sardinia, summer 1943

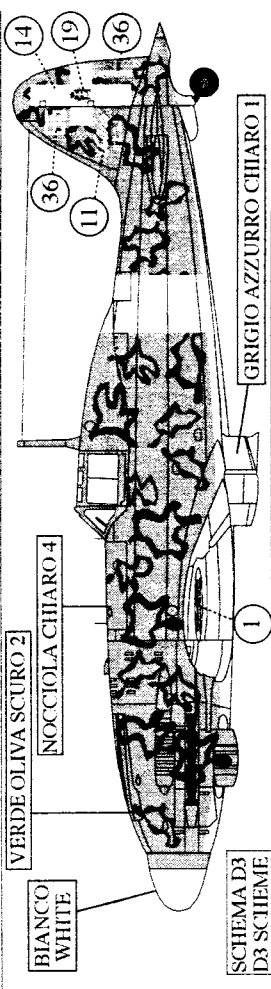

Macchi MC 205 V - 85^a Sq. 18^o Gr. 3^o Sl. summer 1943

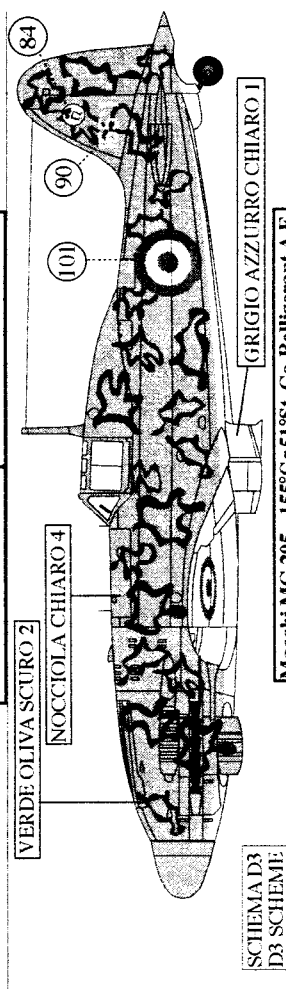

Macchi MC 205 - 155^a Gr. 51^o St. Co-Belligerent A.F.

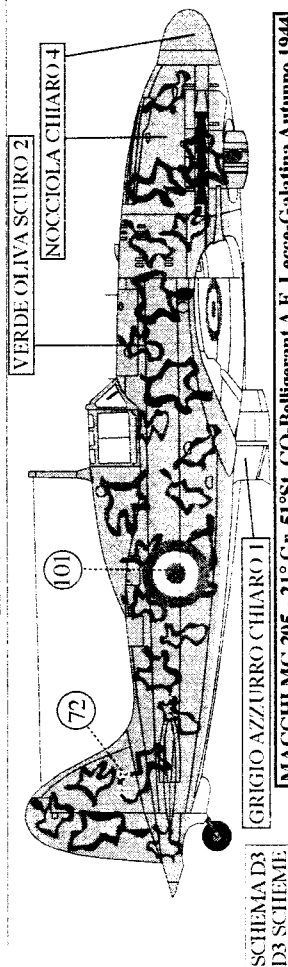

Macchi MC 205 - 21^o Gr. 51^o St. CO-Belligerent A.F. Lecce-Galatina Autunno 1944

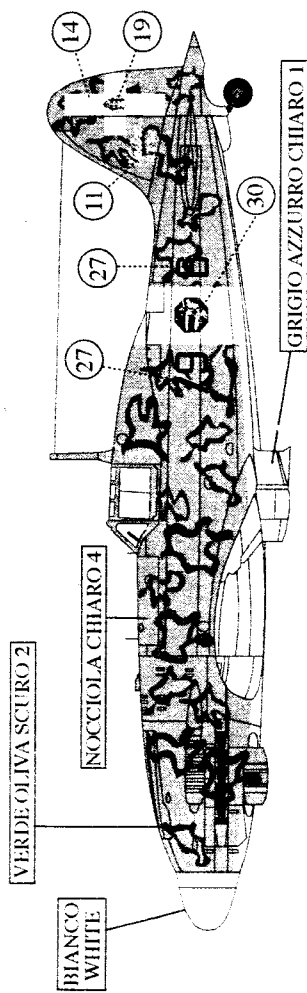

MACCHI MC 205 - 79^aSq. 1^o St. Caccia

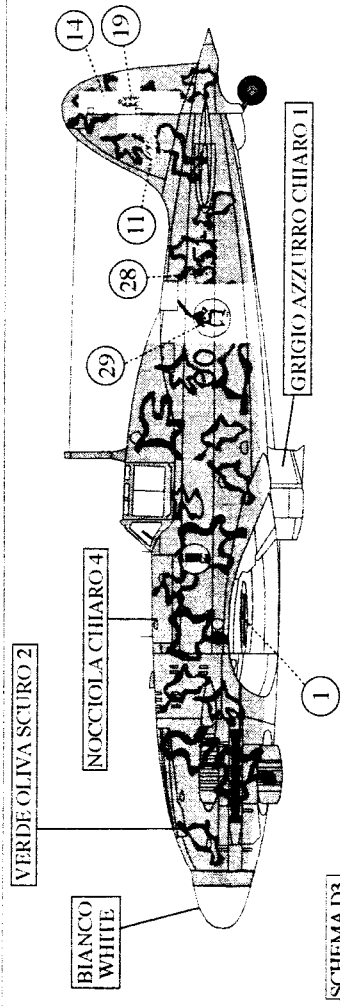

SCHEMA D3
D3 SCHEMIE

MACCHI MC 205 FOTOGRAFICO - 351^aSq.

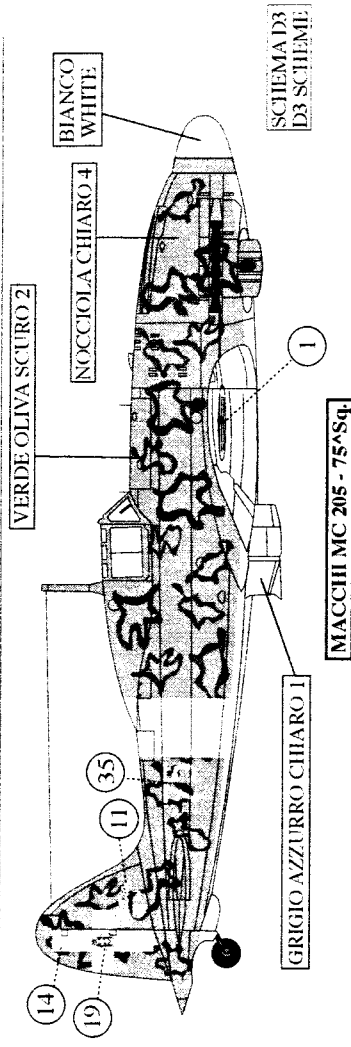

SCHEMA D3
D3 SCHEMIE

MACCHI MC 205 - 75^aSq.

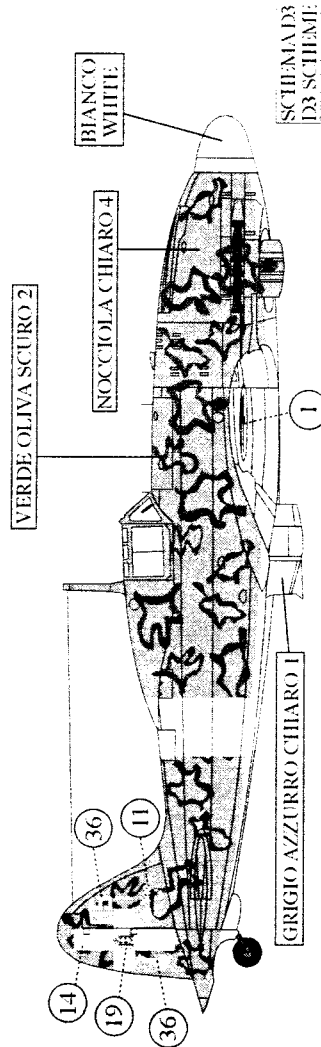

SCHEMA D3
D3 SCHEMIE

Macchi MC 205 - 85^aSq. 18^oGr. 3^oSL 1943

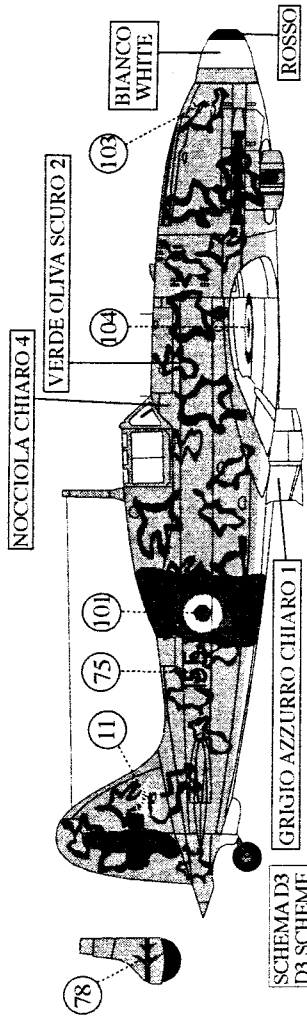

SCHEMA D3
D3 SCHEMIE

MACCHI MC 205 - MM.9348 CO-Belligerant A.F. Lecce-Galatina Autunno 1944

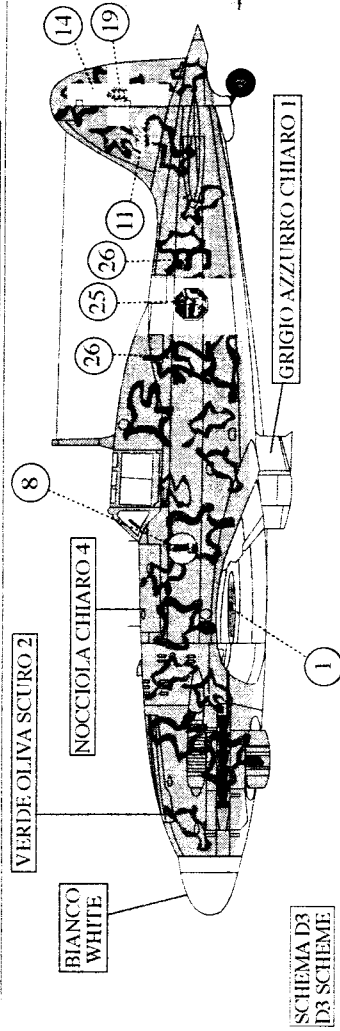

SCHEMA D3
D3 SCHEMIE

MACCHI MC 205V serie I - 72^aSq.

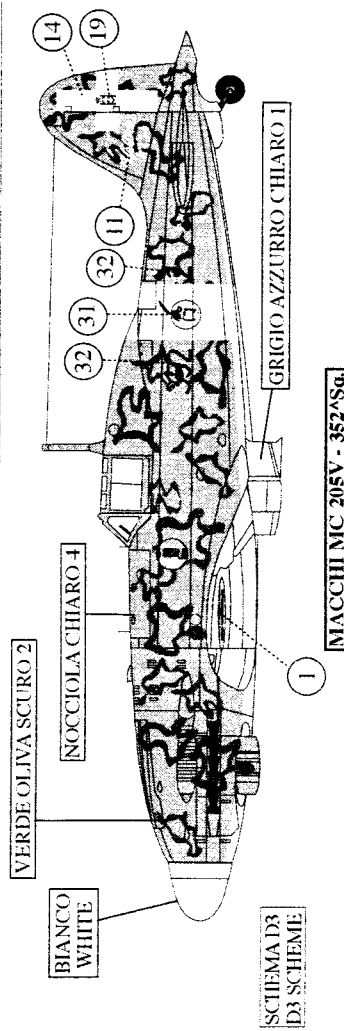

SCHEMA D3
D3 SCHEMIE

MACCHI MC 205V - 352^aSq.

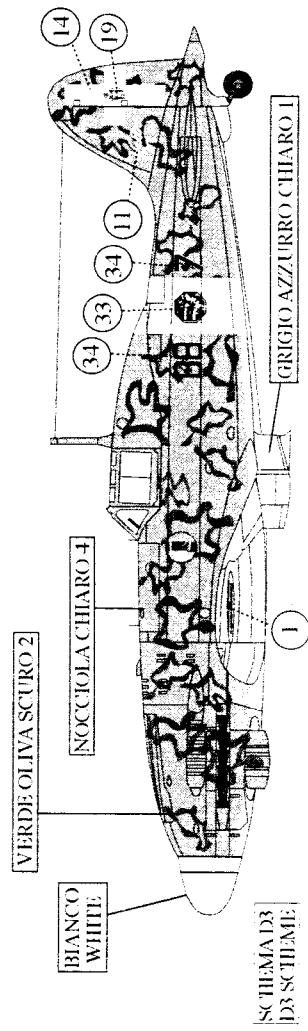

SCHEMA D3
D3 SCHEMIE

MACCHI MC 205V serie I, MM.9313 - 88^aSq. 1^o St. Sicily 1943

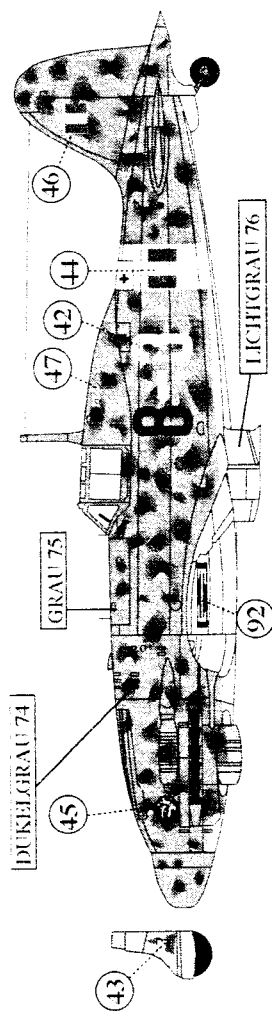

MC 205 V - Serie III - 3^a Sq. 1^o Gr. ANR, Pilot, Ten R. TALAMINI (1 score), Campodiformio, spring 1944

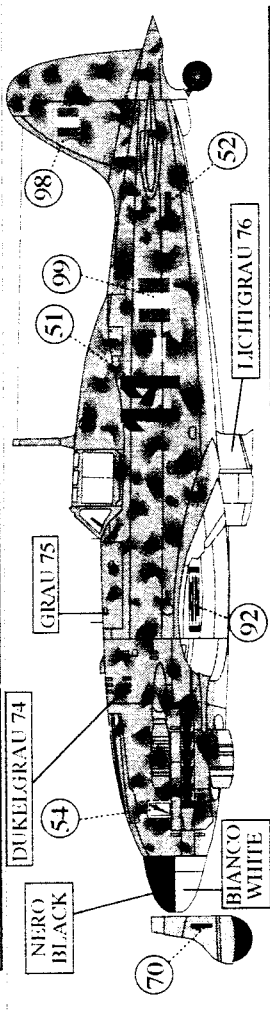

MC 205V, serie III, MM. 92266, 1^a Sq. 1^o Gr. ANR, Pilot M. Ho MAGNAGHI, (2 scores) Campodiformio 1944

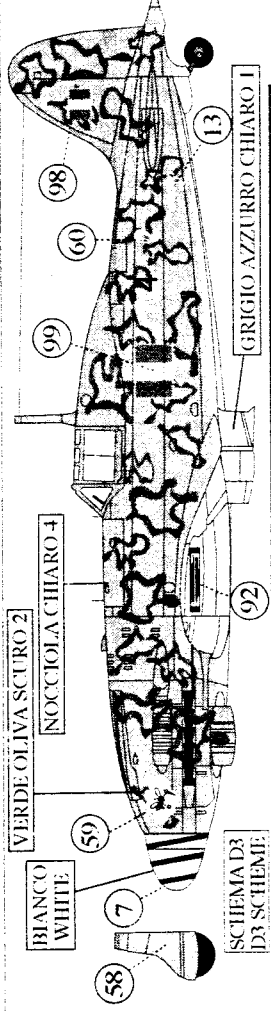

MACCHI C 205V serie III, MM. 92273, 2^a Sq. 1^o Gr. C.T. ANR, Campodiformio, January 1944

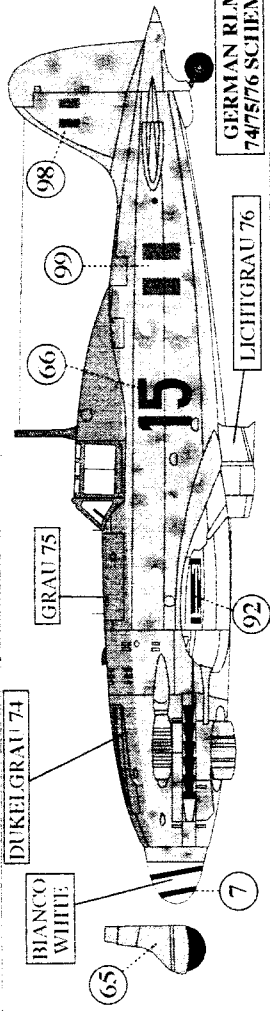

MACCHI C 205 serie III, MM. 92276 - 2^a Sq. 1^o Gr. C. Vicenza, July 1944

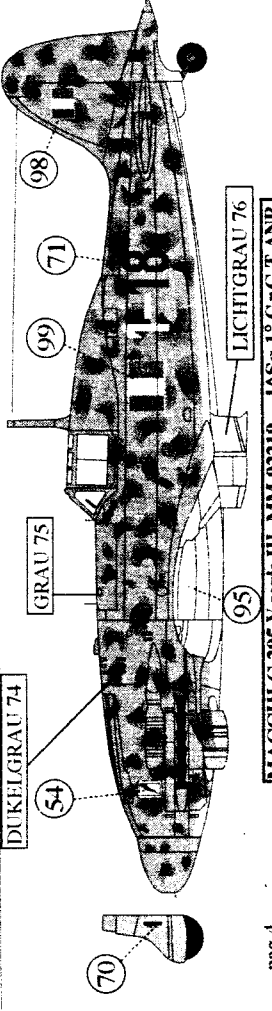

MACCHI C 205 V serie III, MM. 92219, - 1^a Sq. 1^o Gr. C.T. ANR

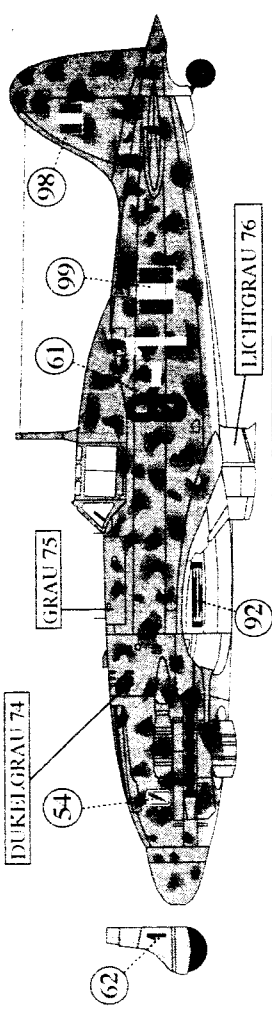

MACCHI C 205V, 1^a Sq. 1^o Gr. C. ANR

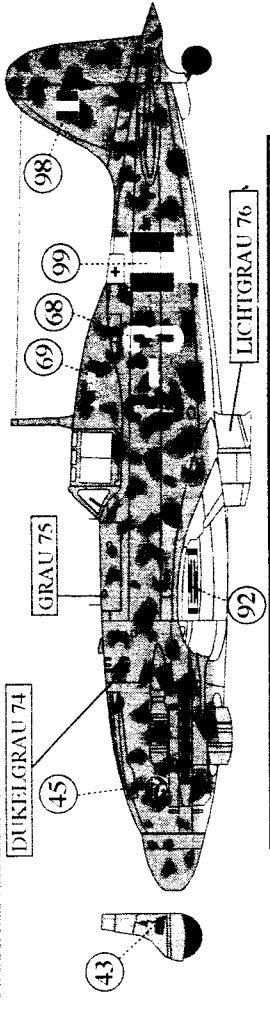

MACCHI C205V serie III - 3^a Sq. 1^o Gr. C.T. ANR, Campodiformio, Spring 1944

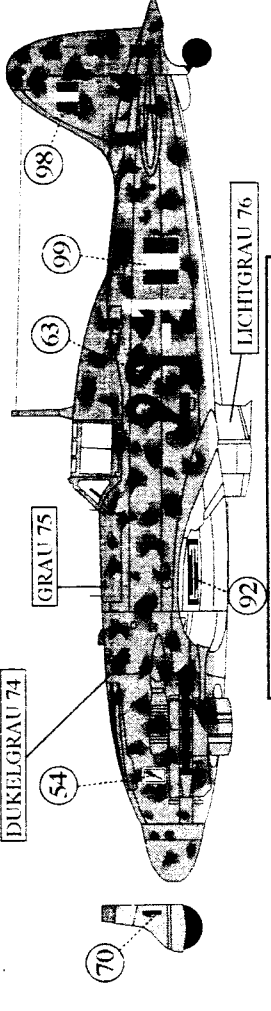

MACCHI C205V serie III, 1^a Sq. 1^o Gr. C.T. ANR

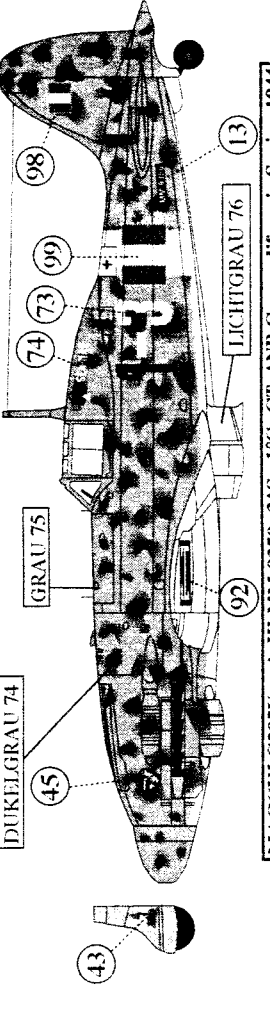

MACCHI C205V serie III MM. 9350 - 3^a Sq. 1^o Gr. C.T. ANR, Campodiformio, Spring 1944

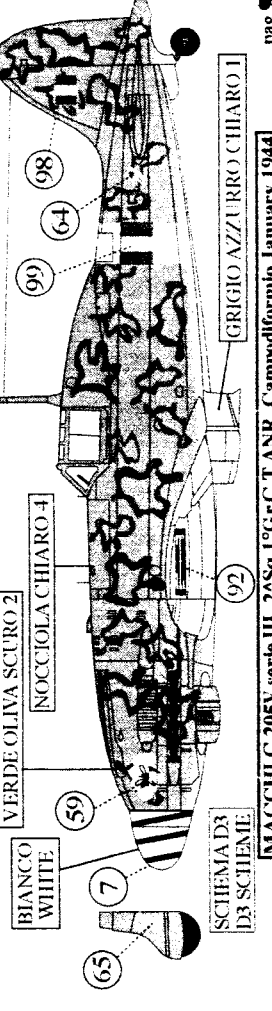

MACCHI C 205V serie III, 2^a Sq. 1^o Gr. C.T. ANR, Campodiformio, January 1944

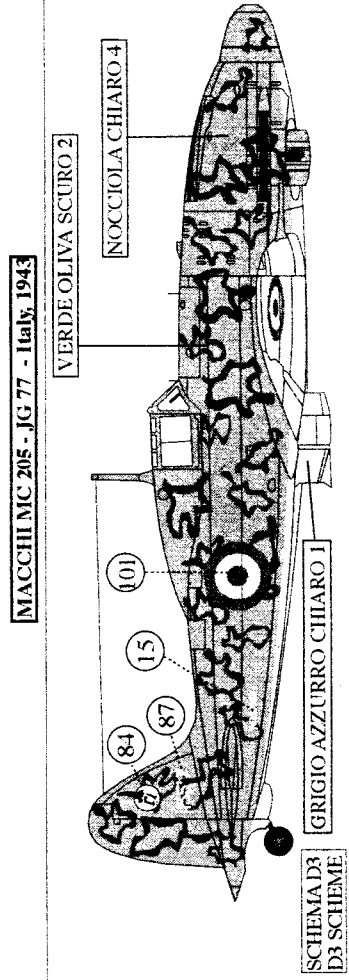
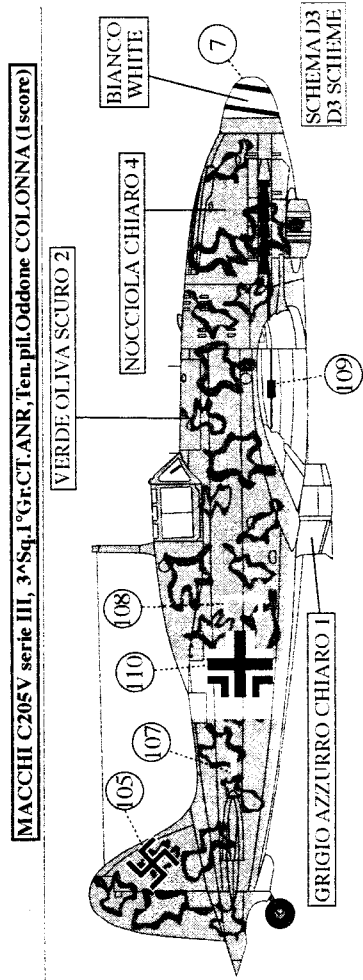
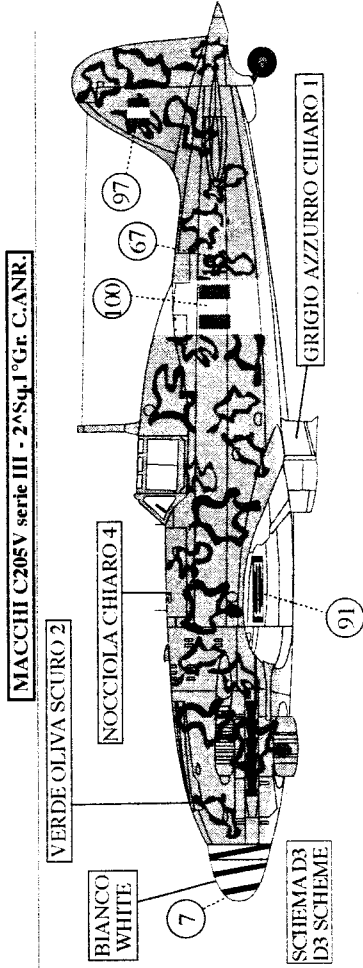
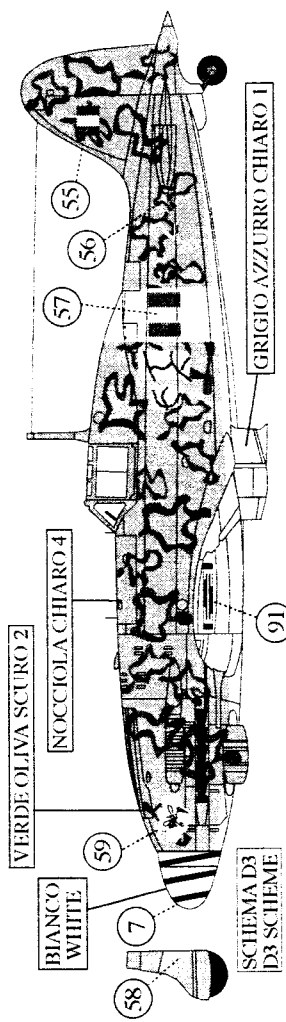

MACCHI MC 205 - MM.9343 - 155°Gr. 51°Sl.CO-Belligerant A.F.

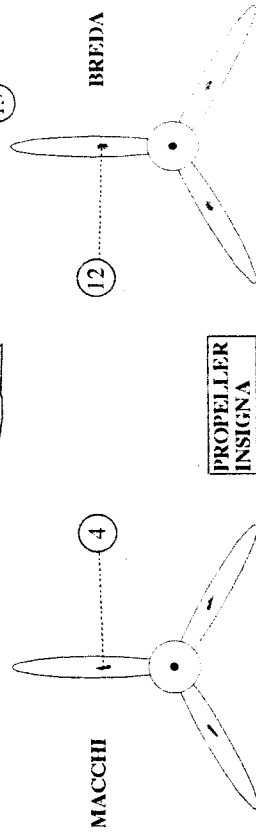
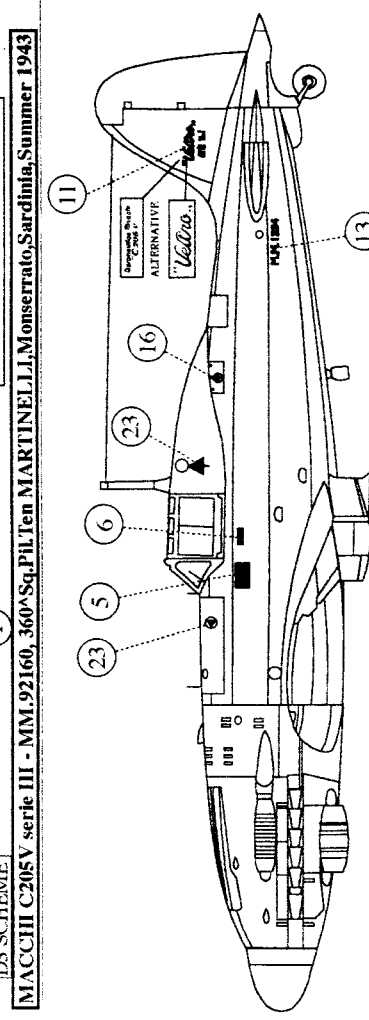
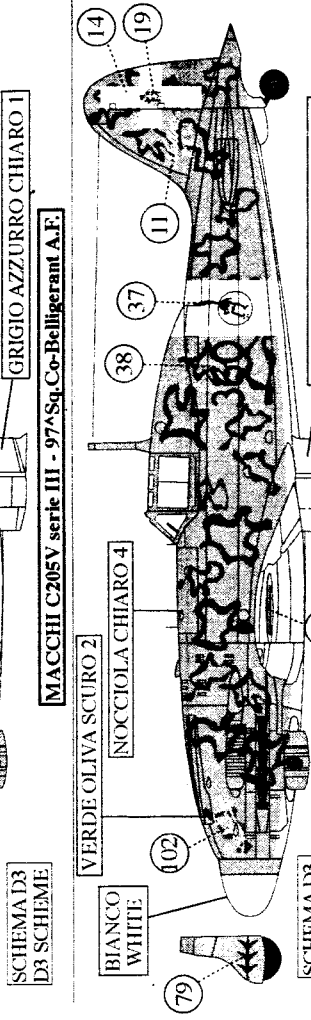
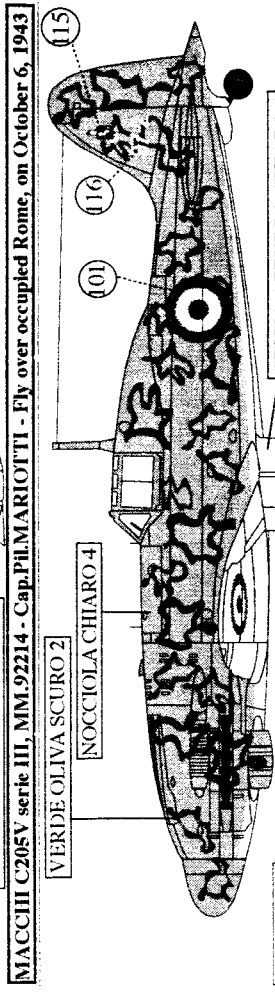
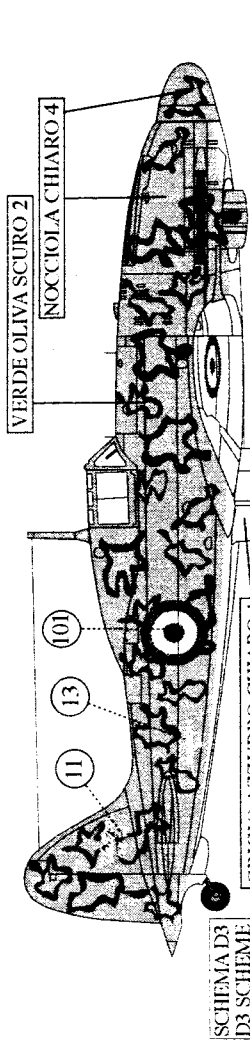

PROPELLER INSIGNA

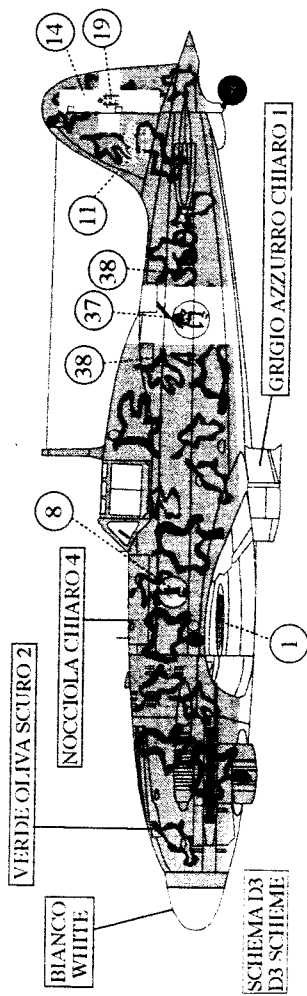

MACCHI C-205V serie I, 360-4, Monserrato, Sardinia, summer 1943

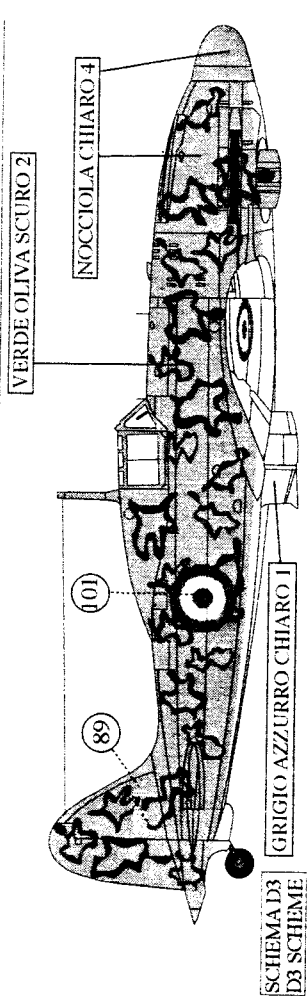

C-205 V - MM.1.9370, pil. Ten A. BALI, ISTA, shot down on November 20, 1944, Albania

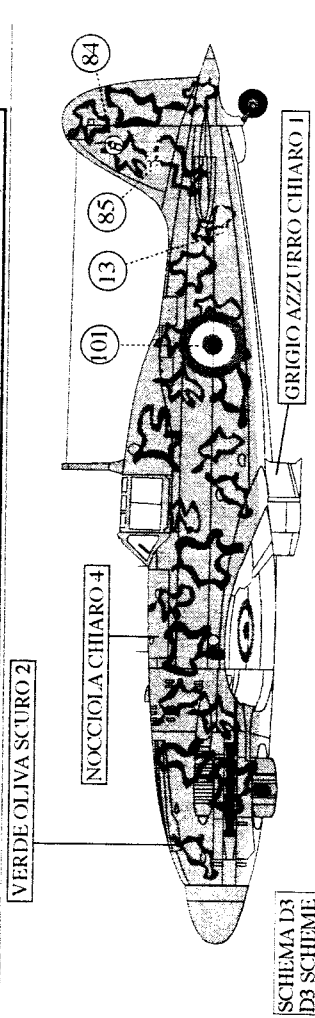

MACCHI C205V - MM.1.9397, AMI, Lecce, early 1946

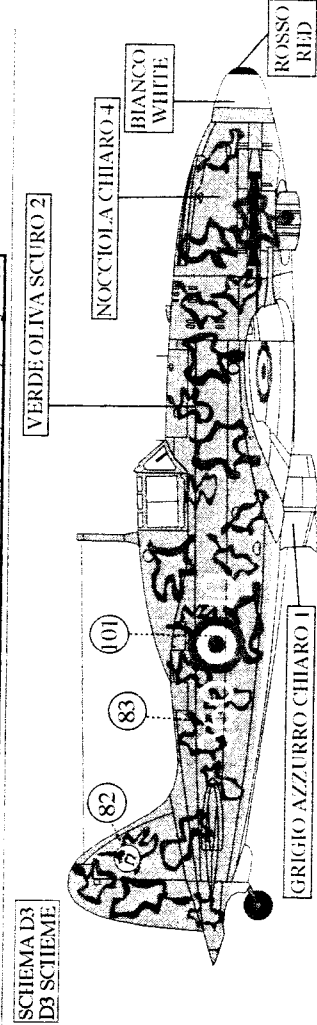

MACCHI MC 205 - 360° Gr. CO-Belligeranti A.F.

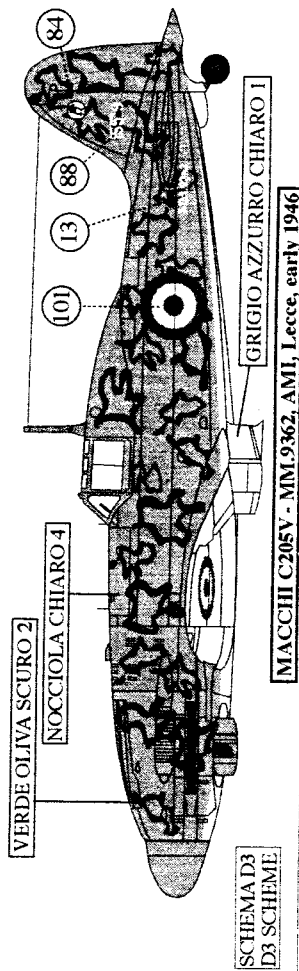

MACCHI C205V - MM.1.9362, AMI, Lecce, early 1946

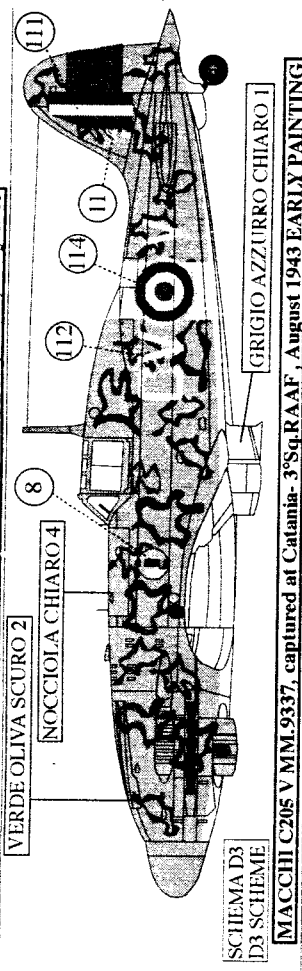

MACCHI C205 V MM.1.9337, captured at Catania - 3°Sq.RAAF, August 1943 EARLY PAINTING

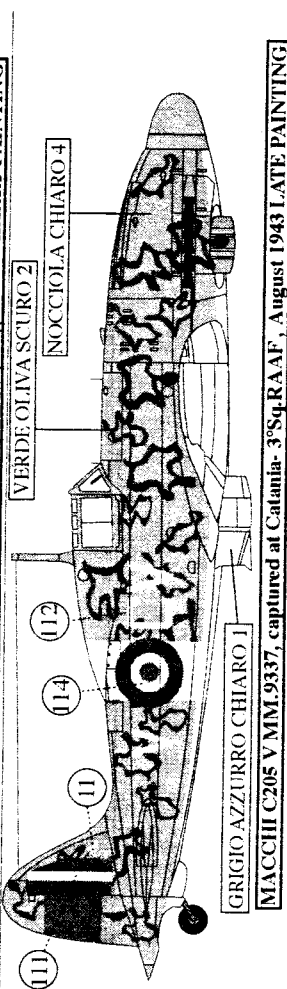

MACCHI C205 V MM.1.9337, captured at Catania - 3°Sq.RAAF, August 1943 LATE PAINTING

