

eduard  
MASK

# JIN Gekko 1/48

The die-cut mask for accurate canopy frame painting of the  
*Tamiya* scale 1/48 KIT

EX 097

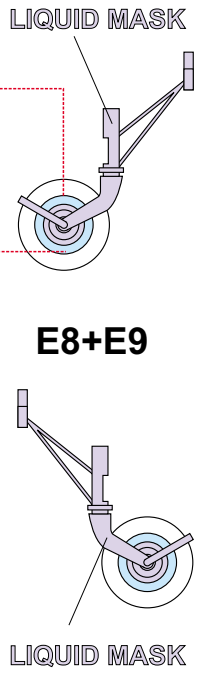
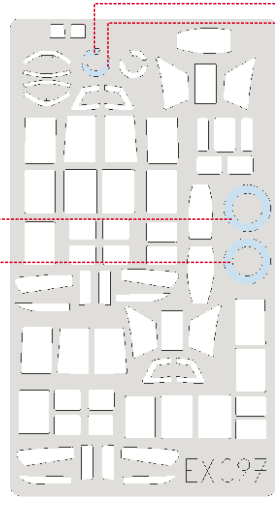
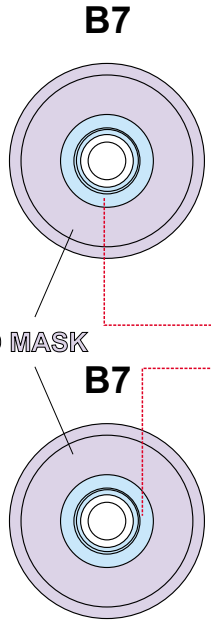
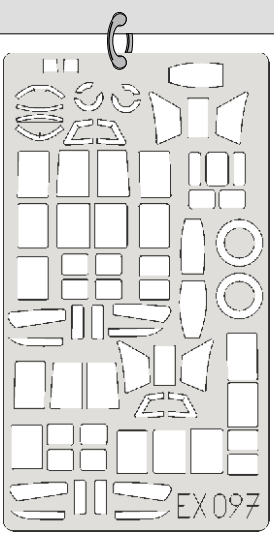

1.)

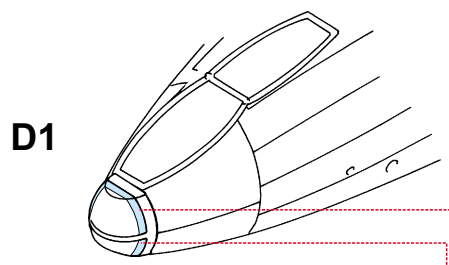

D1

2.)

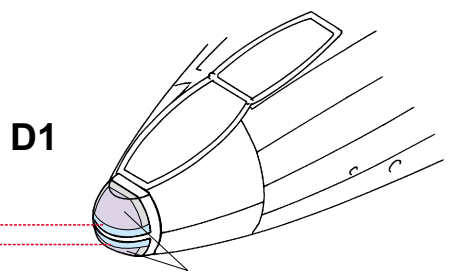

D1

LIQUID MASK

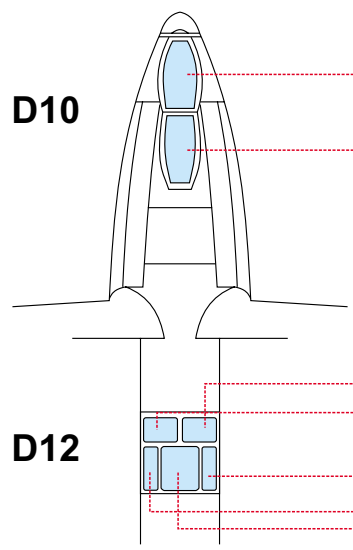

D10

D12

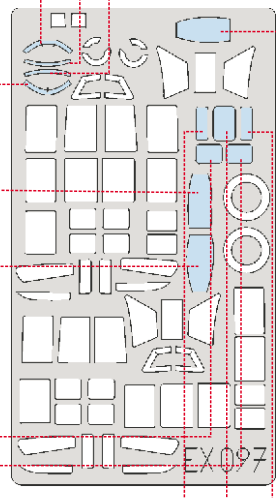

EX097

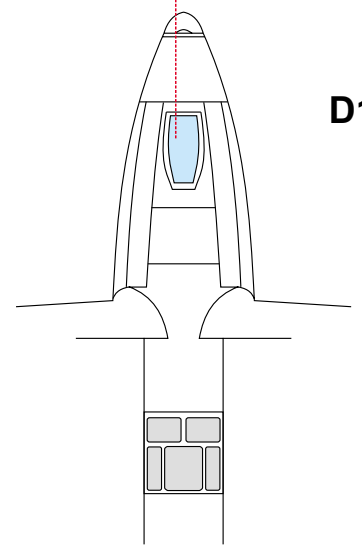

D11

1.)

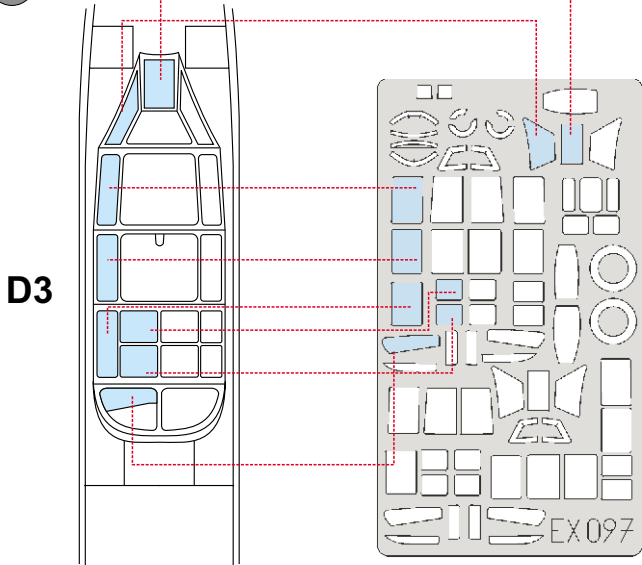

2.)

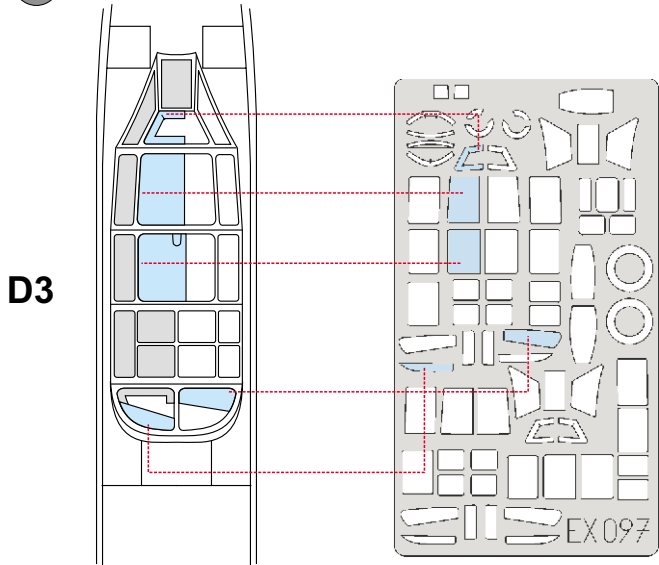

D3

D3

3.)

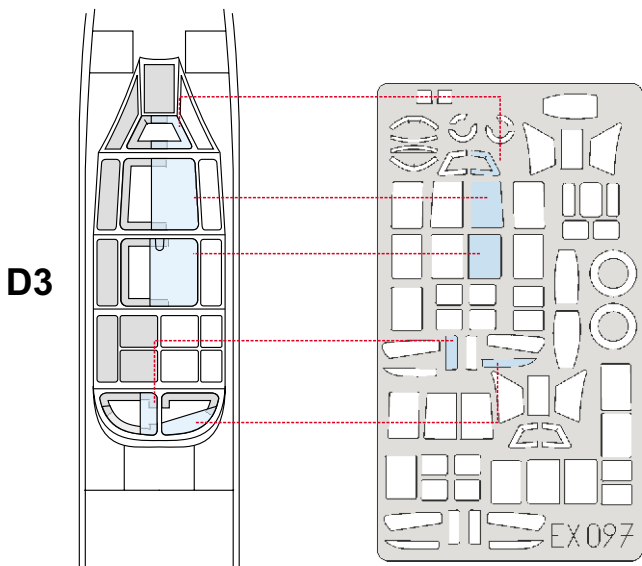

4.)

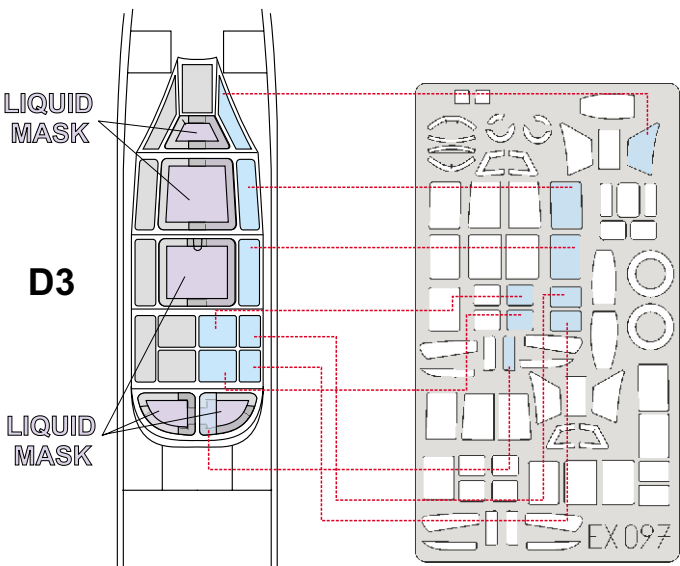

D3

D3

LIQUID MASK

LIQUID MASK

D9

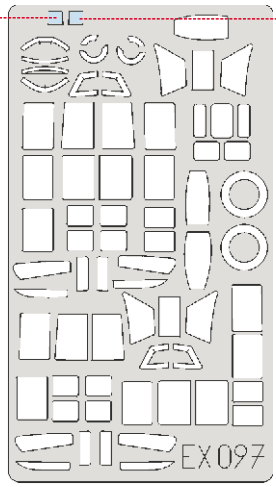
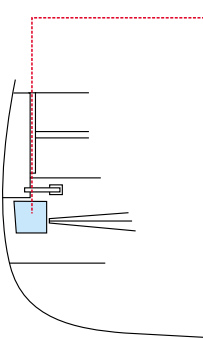

D9

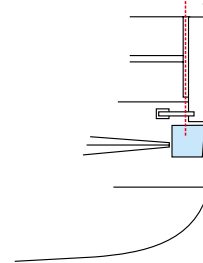

1.)

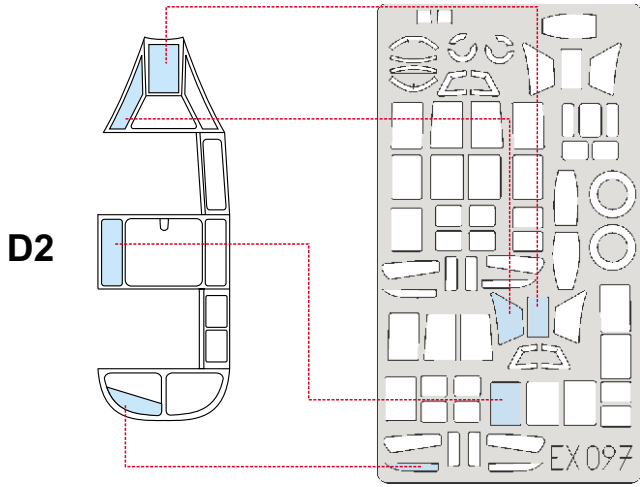

2.)

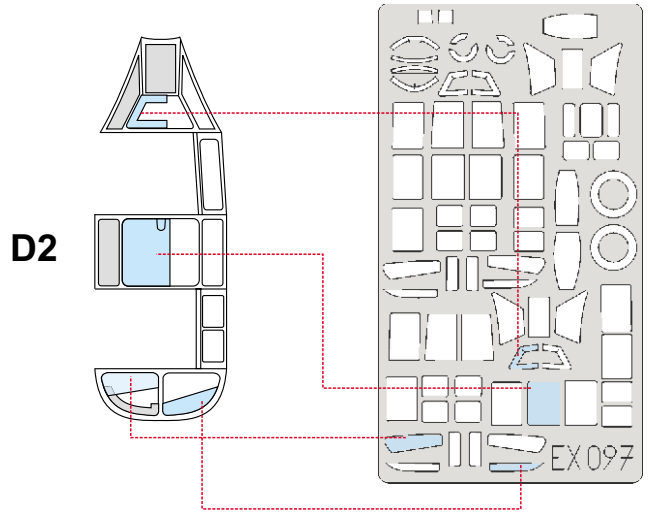

3.)

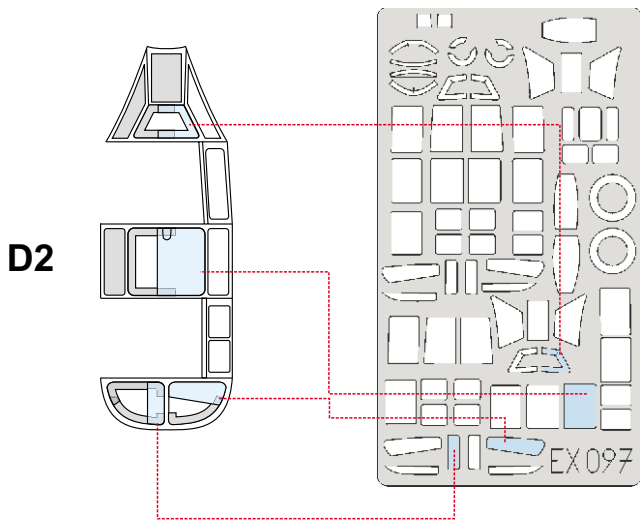

4.)

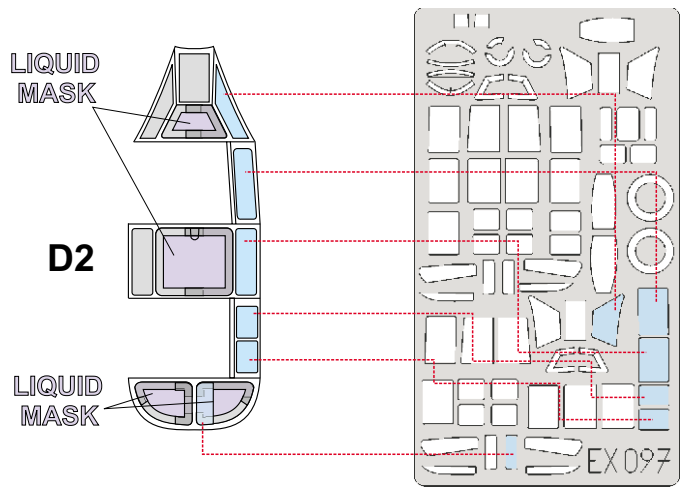

1.)

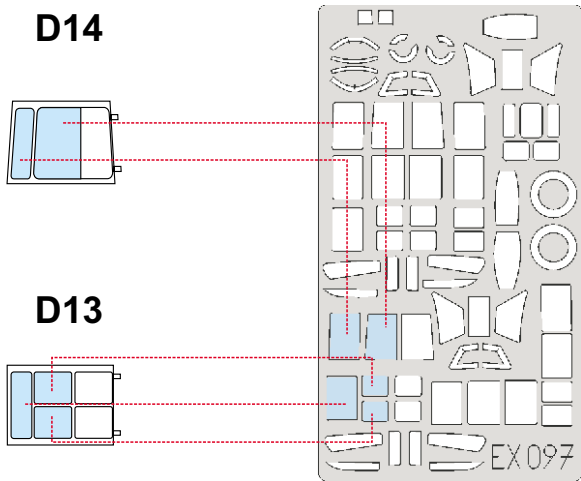

2.)

