

1/35 MILITARY MINIATURE VEHICLE UPGRADE SERIES PE35445









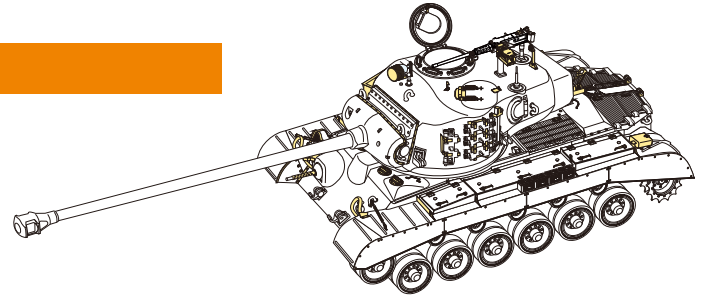
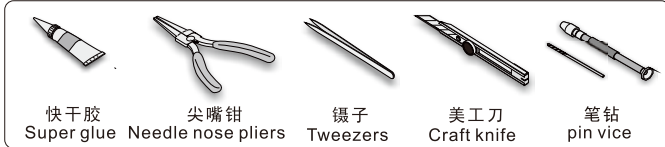

# WWII US Army T26E4 Super Pershing Tank Basic

## 二战美军 T26E4 超级潘兴 中型坦克改造件

[For TAMIYA 35274]

### 推荐使用工具 RECOMMENDED TOOLS



-   
**安装**  
install
-   
**折叠**  
bend
- A1**  
改造件零件编号  
PE/resin part number
- B12**  
原零件编号  
kit part number
- C22**  
被替换的原零件编号  
replaced kit part number
-   
 另一侧相同制作  
repeat on opposite side
-   
**切除**  
remove
-   
**打磨**  
grind off
-   
**弧度卷曲**  
radial bending
-   
**制作若干组**  
multiple assembly
-   
**选择安装**  
alternative
-   
**钻孔**  
drill
-   
**注意**  
caution

  
 用尖端在凹槽处冲压  
use penpoint to press on the dent

蚀刻片零件内侧面向上  
Put the part upside down  
 用笔尖在凹槽处刺  
Use penpoint to press on the dent

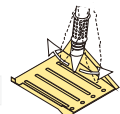

**a** A105, A20, A40, A41, A42, Ø0.3

**b** A10, Resin part

**c** A10, Resin part

**d** B10, A57, A75 (内侧 Inside / 外侧 Outside), A74, Resin part, Kit part, A69, x3

**e** A15, A43, A44, Ø0.5, Ø0.3

**f** A67, A38, A6, B8, A97, B27, B28, Ø0.5

**g** B9, B12, B17, Metal part

1/35 MILITARY MINIATURE VEHICLE UPGRADE SERIES PE35445

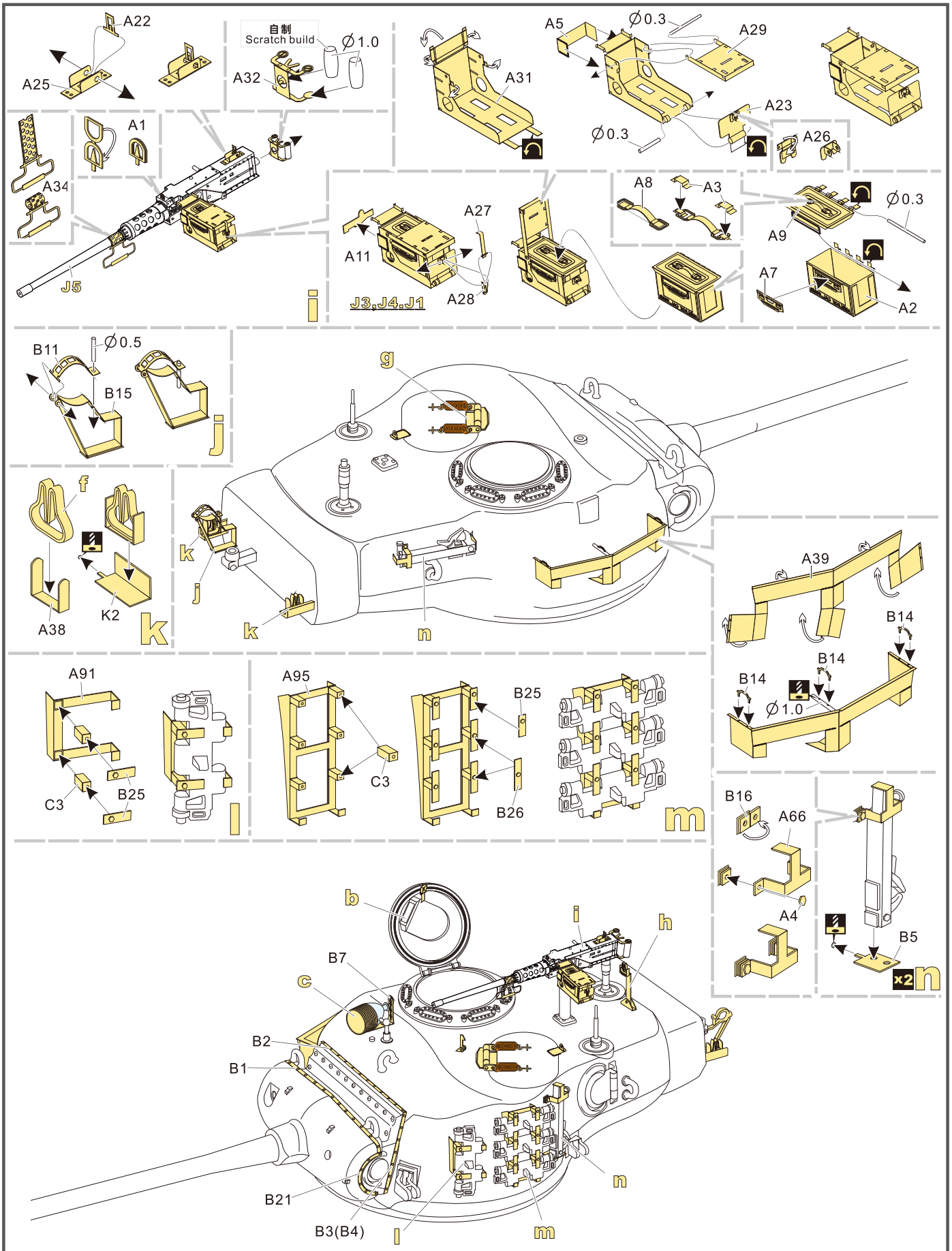

1/35 MILITARY MINIATURE VEHICLE UPGRADE SERIES PE35445

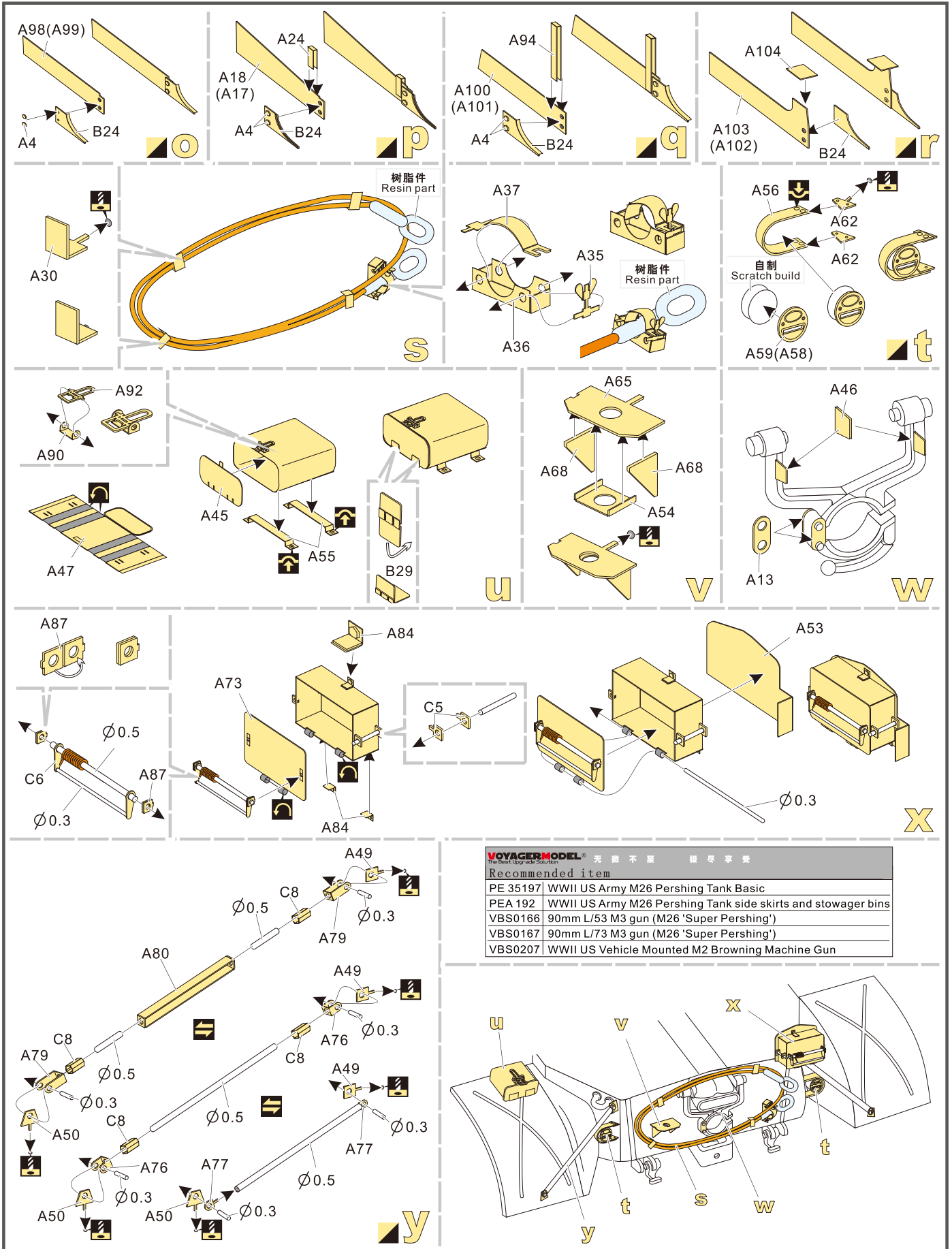

**VOYAGERMODEL®** 无微不至 悦享享受  
The Best Upgrade Solution

Recommended item

PE 35197	WWII US Army M26 Pershing Tank Basic
PEA 192	WWII US Army M26 Pershing Tank side skirts and stowager bins
VBS0166	90mm L/53 M3 gun (M26 'Super Pershing')
VBS0167	90mm L/73 M3 gun (M26 'Super Pershing')
VBS0207	WWII US Vehicle Mounted M2 Browning Machine Gun

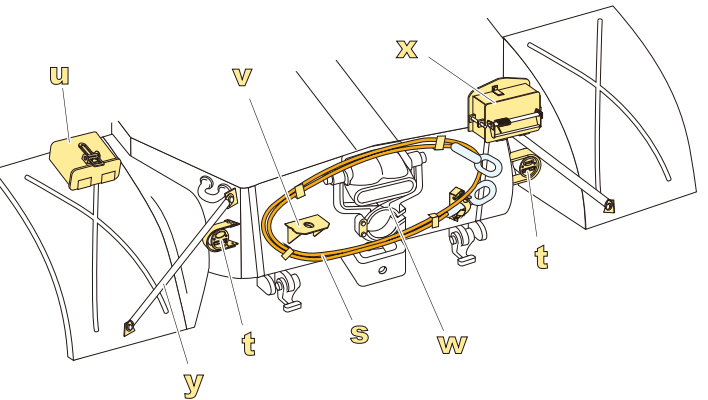

1/35 MILITARY MINIATURE VEHICLE UPGRADE SERIES PE35445

