

QUANG-TRUNG

729

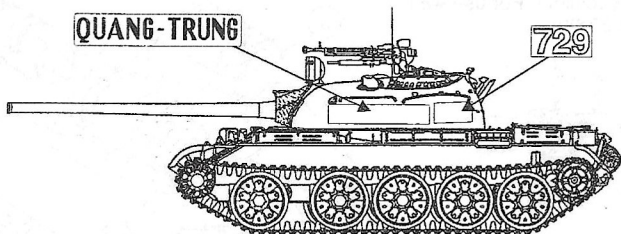

T-54 North Vietnamese Army , 1972. Spring invasion near Dong Ha. Soviet Green
T-54 ВС Северного Вьетнама, 1972, Хаки..

2322

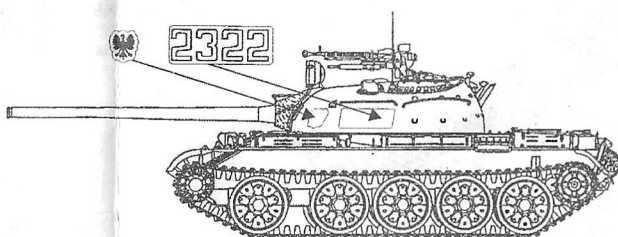

T-54 Polish LWP , early 60th. Soviet Green
T-54 Войска Польского, начало 60-ых, Хаки.

93

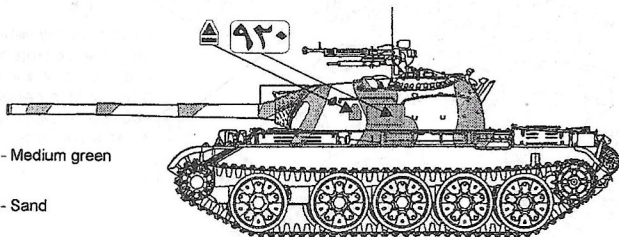

T-54 Egyptian Army , 1973. Vehicle fitted with an AEG-Telefunken infrared searchlight.
T-54 Египетской армии, война с Израилем 1973,оснащён АЕG-Telefunken ИК подсветкой.

Soviet

E. German

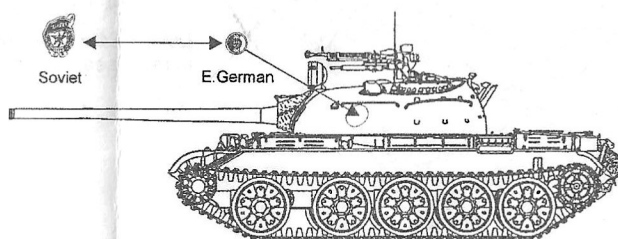

T-54 Soviet Army Guard regiment (East German Army), mid 60-th. Soviet green
T-54 Гвардейских частей СА (Армии ГДР), середина 60-ых. Хаки.

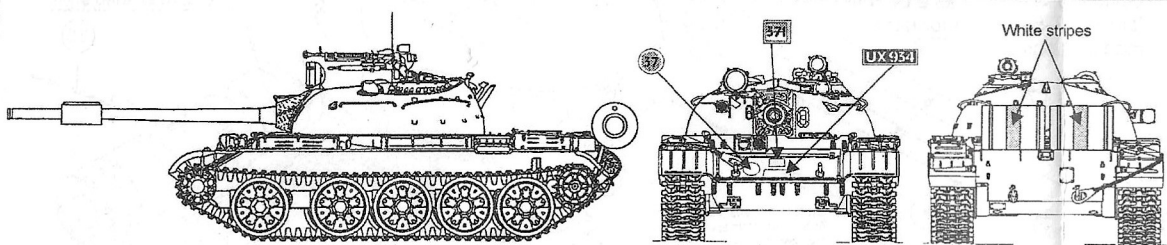
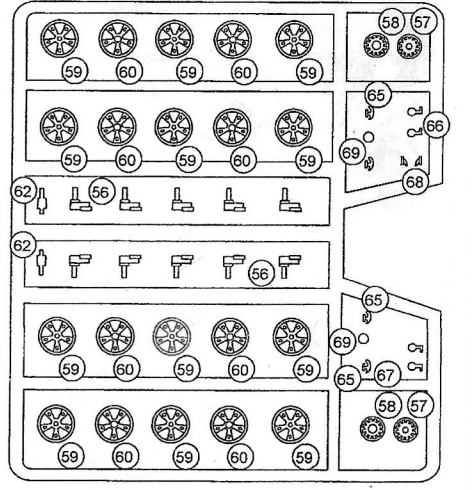
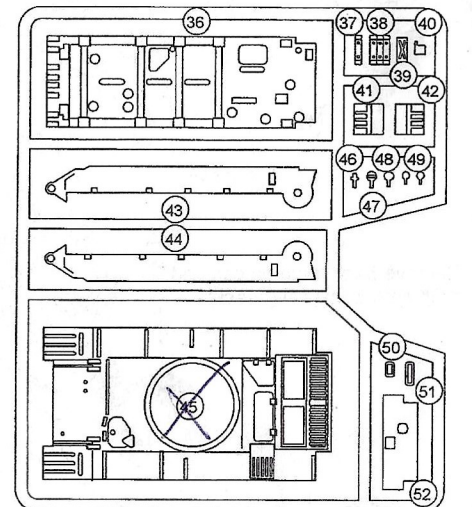
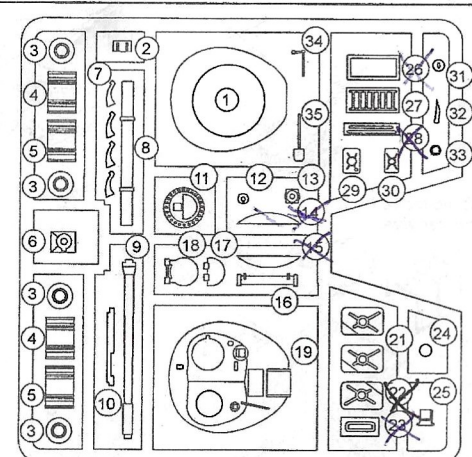

T-54 Indian Army, 9th Deccan Horse or 72nd Armored Regiment used in fighting with Pakistani forces near Chaamb in the 1971 war.
The Indians added a simple metal can over the barrel to mimic the L7 105mm gun. Soviet green.

T-54 ВС Индии, 1971 г. Металлическая ёмкость на стволе для визуального сходства орудия с более мощной 105мм пушкой L7 .

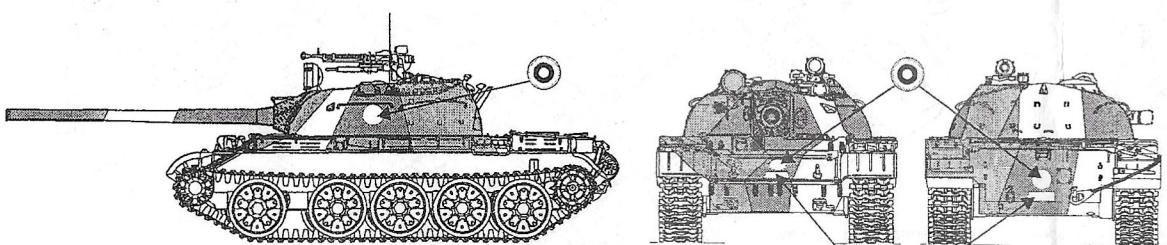

T-54 Finnish Army, mid 80-th.
T-54 ВС Финляндии, середина 80-ых.

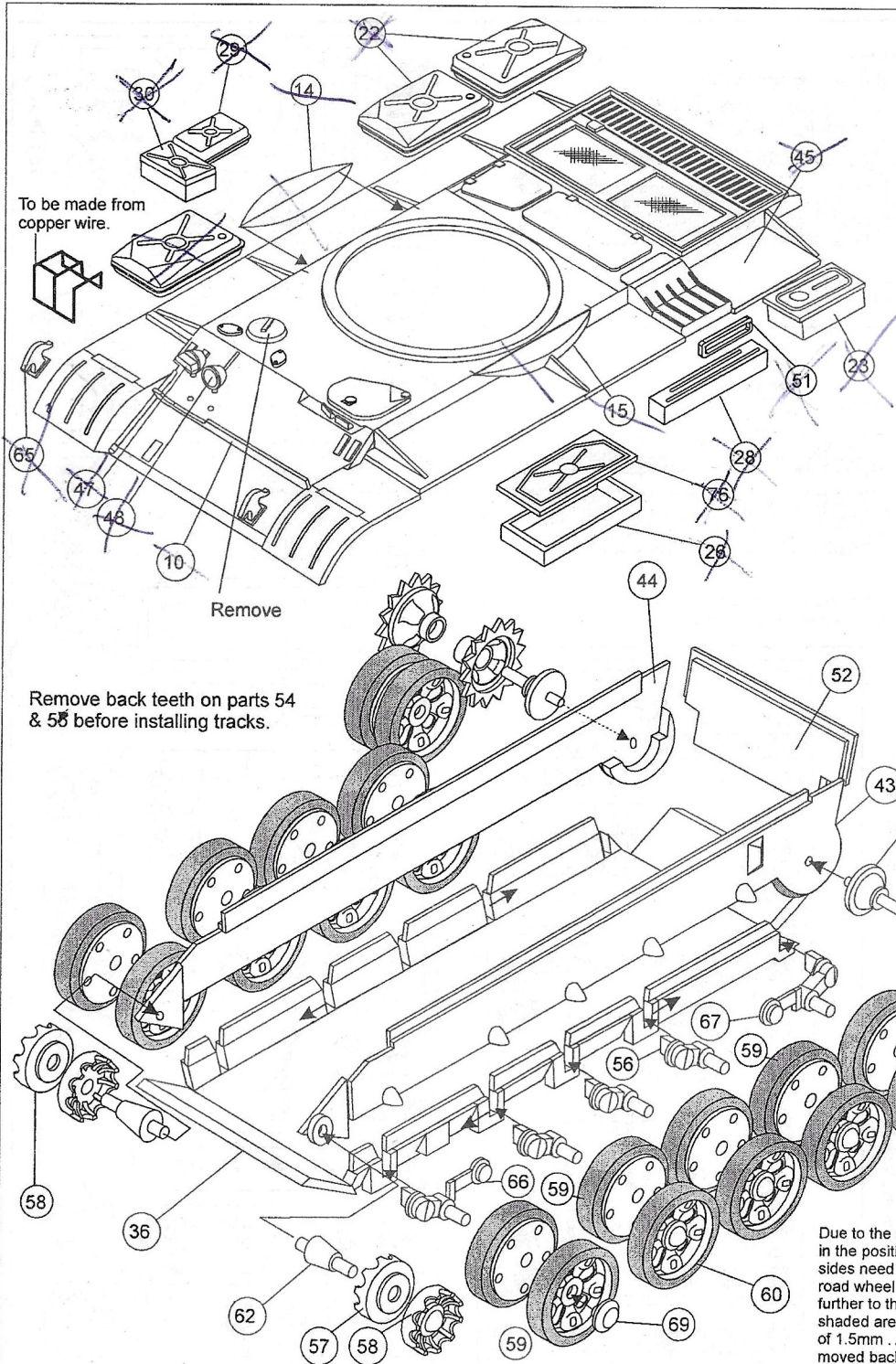

**T-54 MBT
kit #72140**

AEG-Telefunken infrared searchlight. For use with Egyptian vehicle only (parts 88-90).

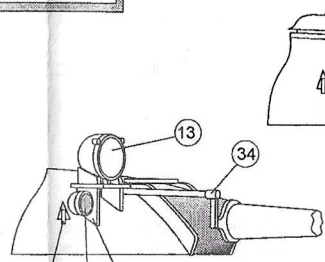

Later T-54 modifications with infrared searchlight.

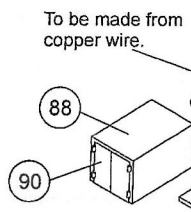

To be made from copper wire.

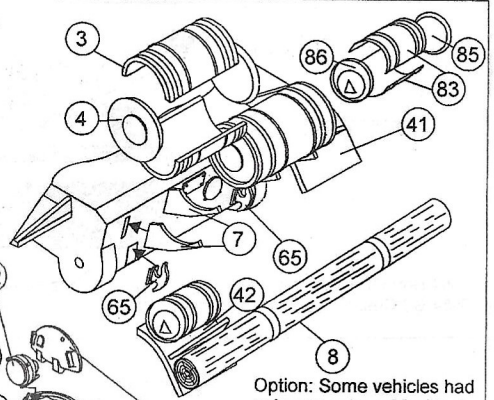

Option: Some vehicles had only one external fuel tank in a middle of a vehicle with a two smoke generators (83+85+86) at sides. Use parts 81 as a supports.

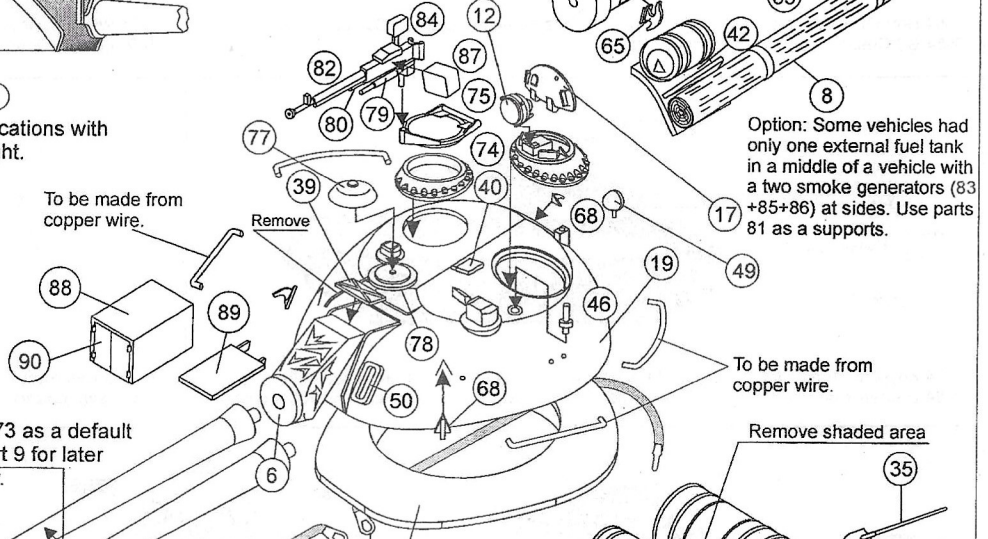

Remove

To be made from copper wire.

Remove shaded area

Option: Use part 73 as a default for most T-54. Part 9 for later modifications only.

Cable is not included.
To be made from spined thread.
Трос изготовить из скрученной нити.
В набор не входит.

Due to the moulding procedure, certain errors have occurred in the positioning of the wheels. The second road wheel on both sides need to be attached 1mm further forward, the fourth road wheel on both sides needs to be attached 1mm further to the rear. Also a portion of the left hand side, the shaded area in the diagram, needs to be cut away to the depth of 1.5mm. As a result of this both drive sprockets need to be moved back 1mm.

Made in Ukraine by ACE. Copyright 2002.

Check for historical photos of this and other vehicles, detailed description of other ACE kits, new products and more at:
<http://www.acemodel.com.ua>