

1/35 MILITARY MINIATURE VEHICLE UPGRADE SERIES PE35756









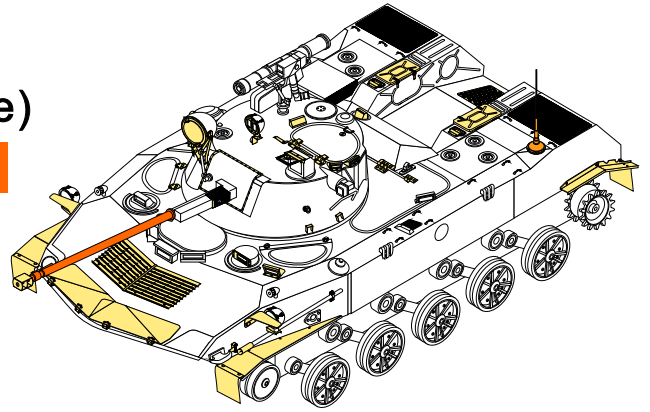
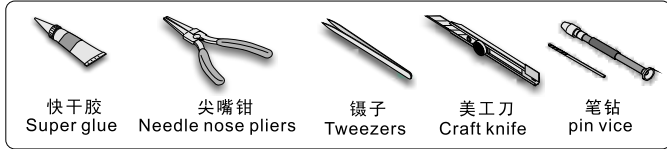

Modern Russian BMD-2 Airborne Fighting Vehicle (Gun barrel Include)

现代俄罗斯BMD-2伞兵战车改造件（含炮管）

[For panda hobby ph 35009]

■ 推荐使用工具 RECOMMENDED TOOLS



- 
 安装
install
- 
 折叠
bend
- A1**
 改造件零件编号
PE/resin part number
- B12**
 原零件编号
kit part number
- C22**
 被替换的原零件编号
replaced kit part number
- 
 另一侧相同制作
repeat on opposite side
- 
 用尖端在凹槽处冲压
use penpoint to press on the dent
- 
 切除
remove
- 
 打磨
grind off
- 
 弧度卷曲
radial bending
- 
 制作若干组
multiple assembly
- 
 选择安装
alternative
- 
 钻孔
drill
- 
 用胶棒制作
make from plastic rod

用尖端在凹槽处冲压
use penpoint to press on the dent

蚀刻片零件内侧面向上
Put the part upside down

用笔尖在凹槽处刺
Use penpoint to press on the dent

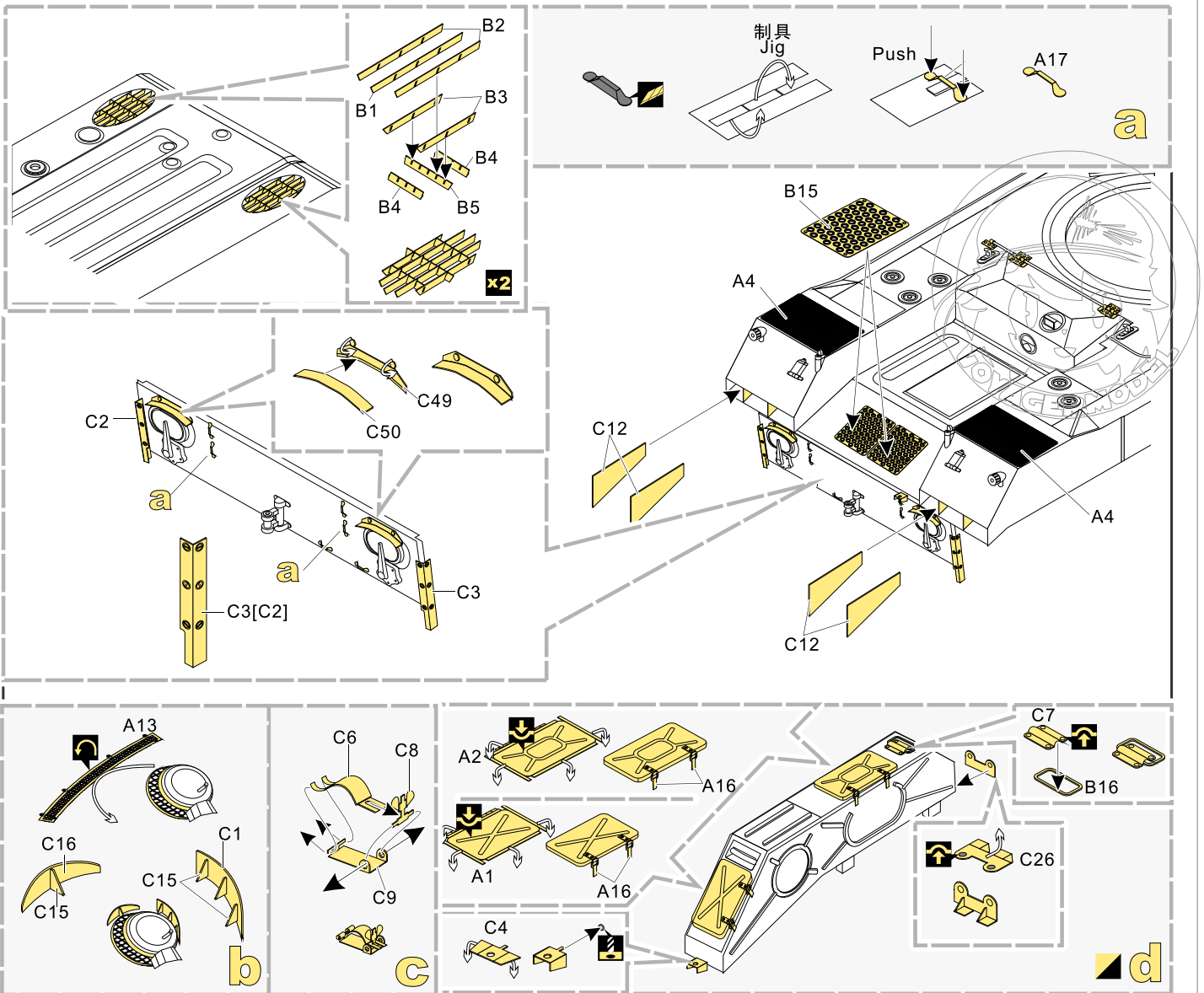
1/35 MILITARY MINIATURE VEHICLE UPGRADE SERIES PE35756

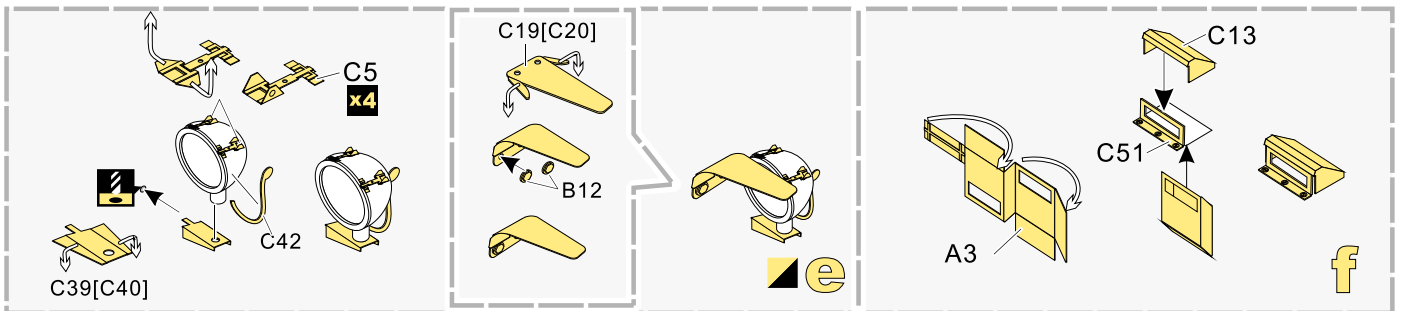
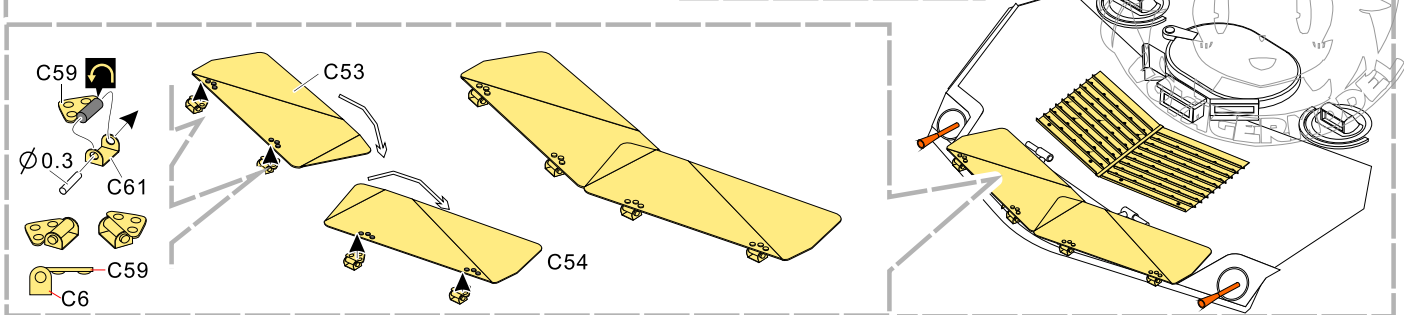
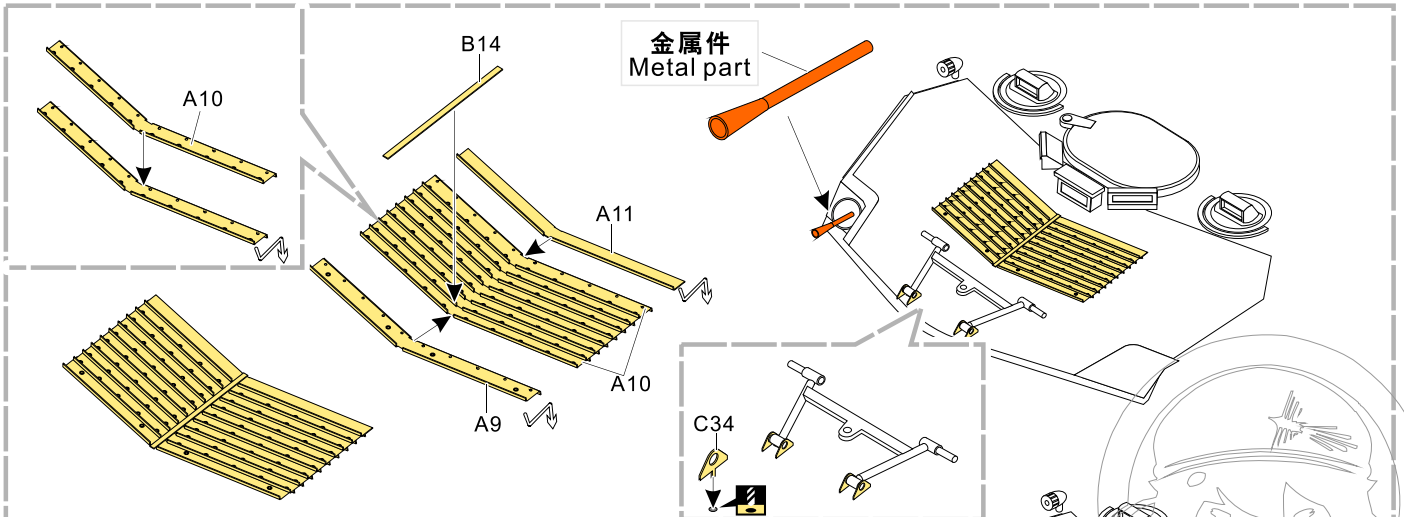
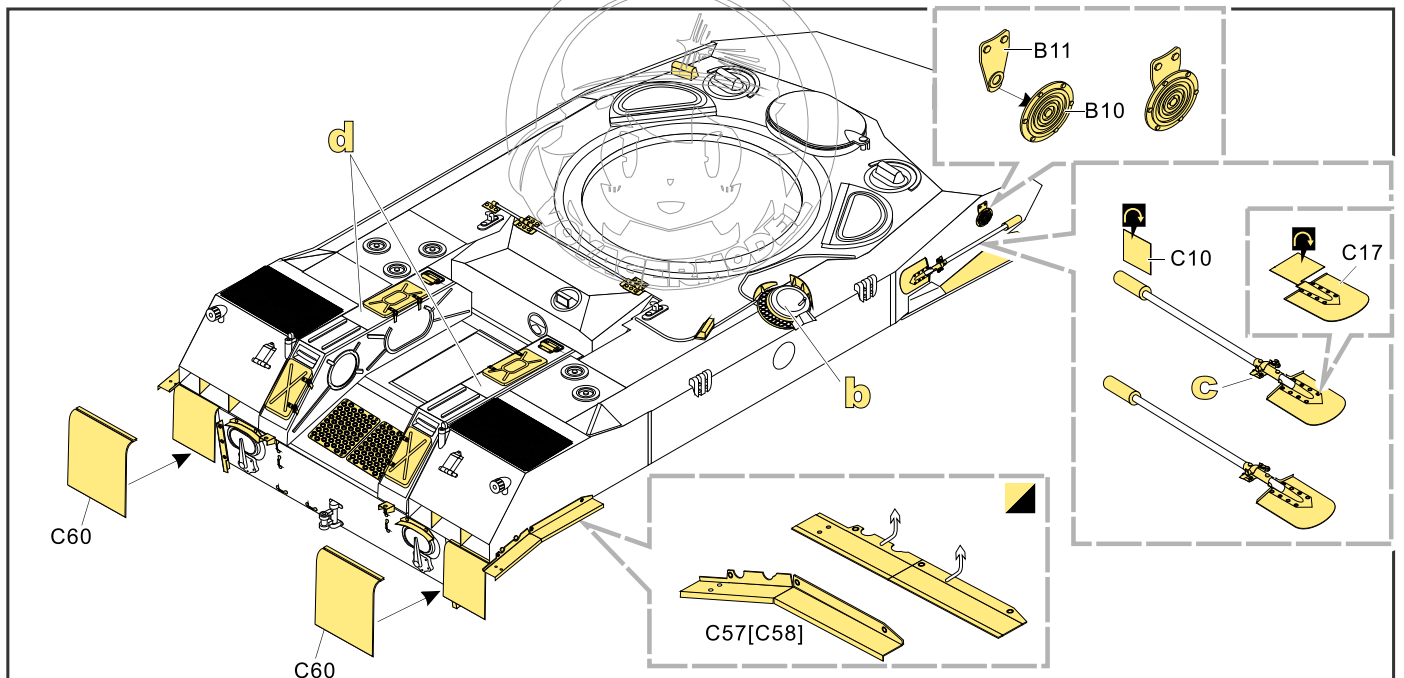

1/35 MILITARY MINIATURE VEHICLE UPGRADE SERIES PE35756

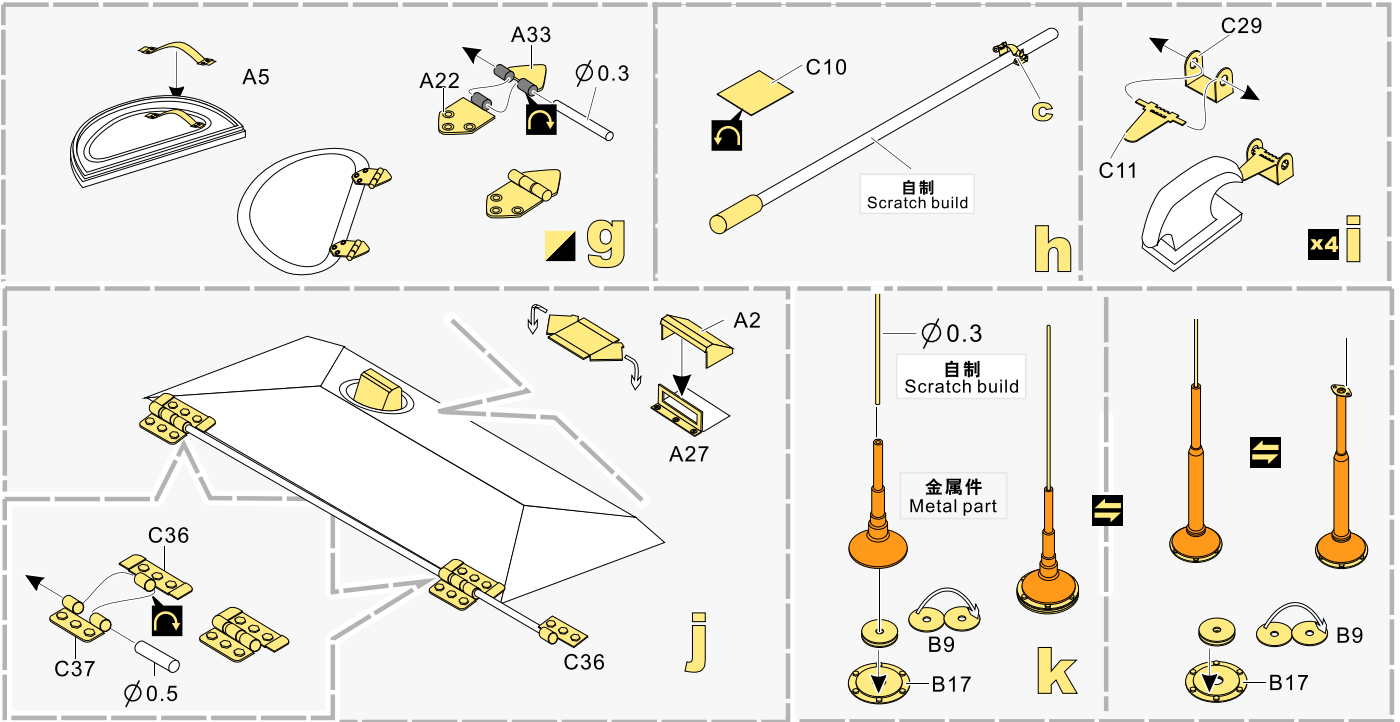

[Http://www.voyagermodel.com/productdetails.asp?itemid=PE35756](http://www.voyagermodel.com/productdetails.asp?itemid=PE35756)



**VOYAGER
MODEL**



更多PE35756样品照片参考请扫一扫
MORE PICTUER OF PE 35756
REFERENCE SCAN HERE

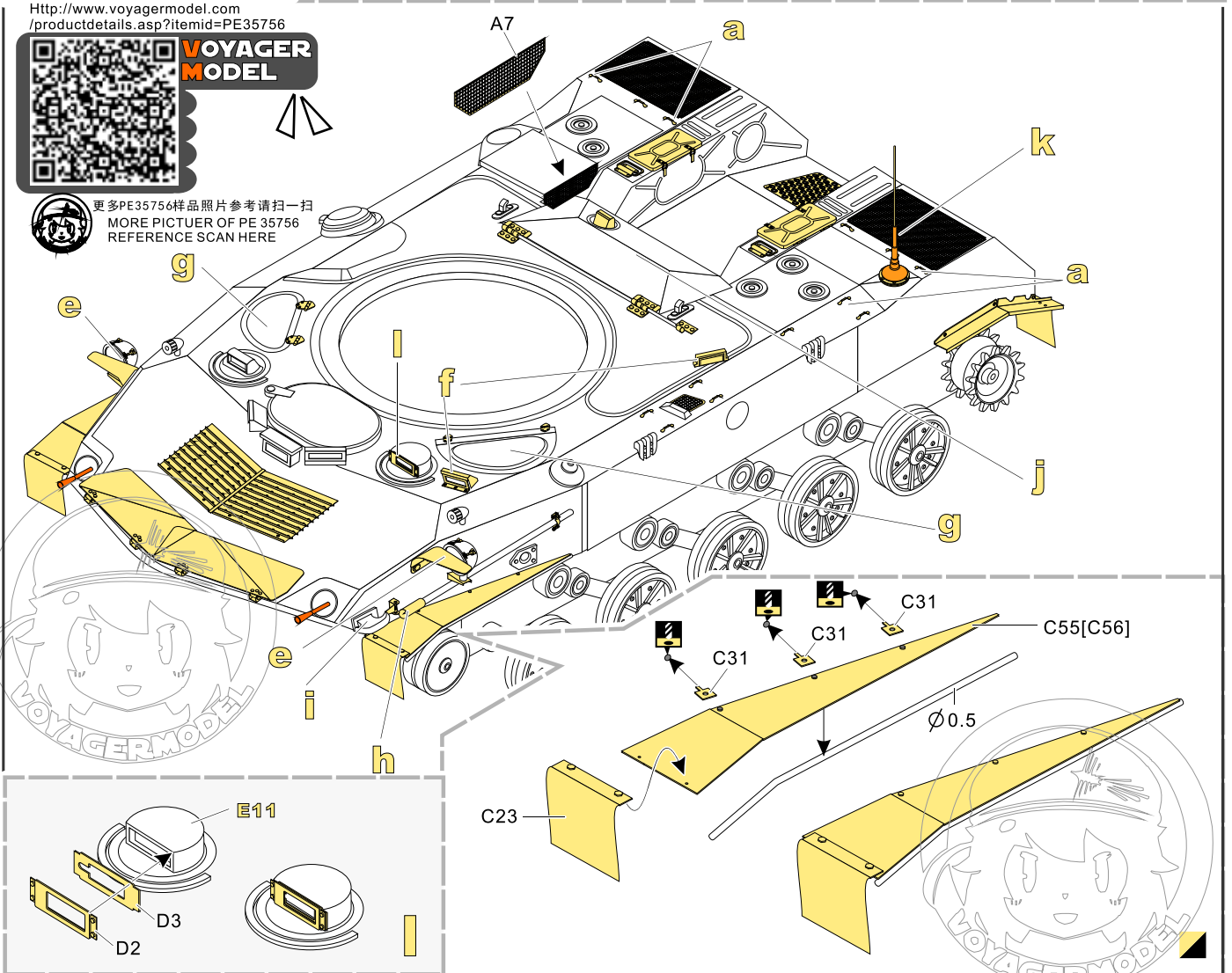

1/35 MILITARY MINIATURE VEHICLE UPGRADE SERIES PE35756

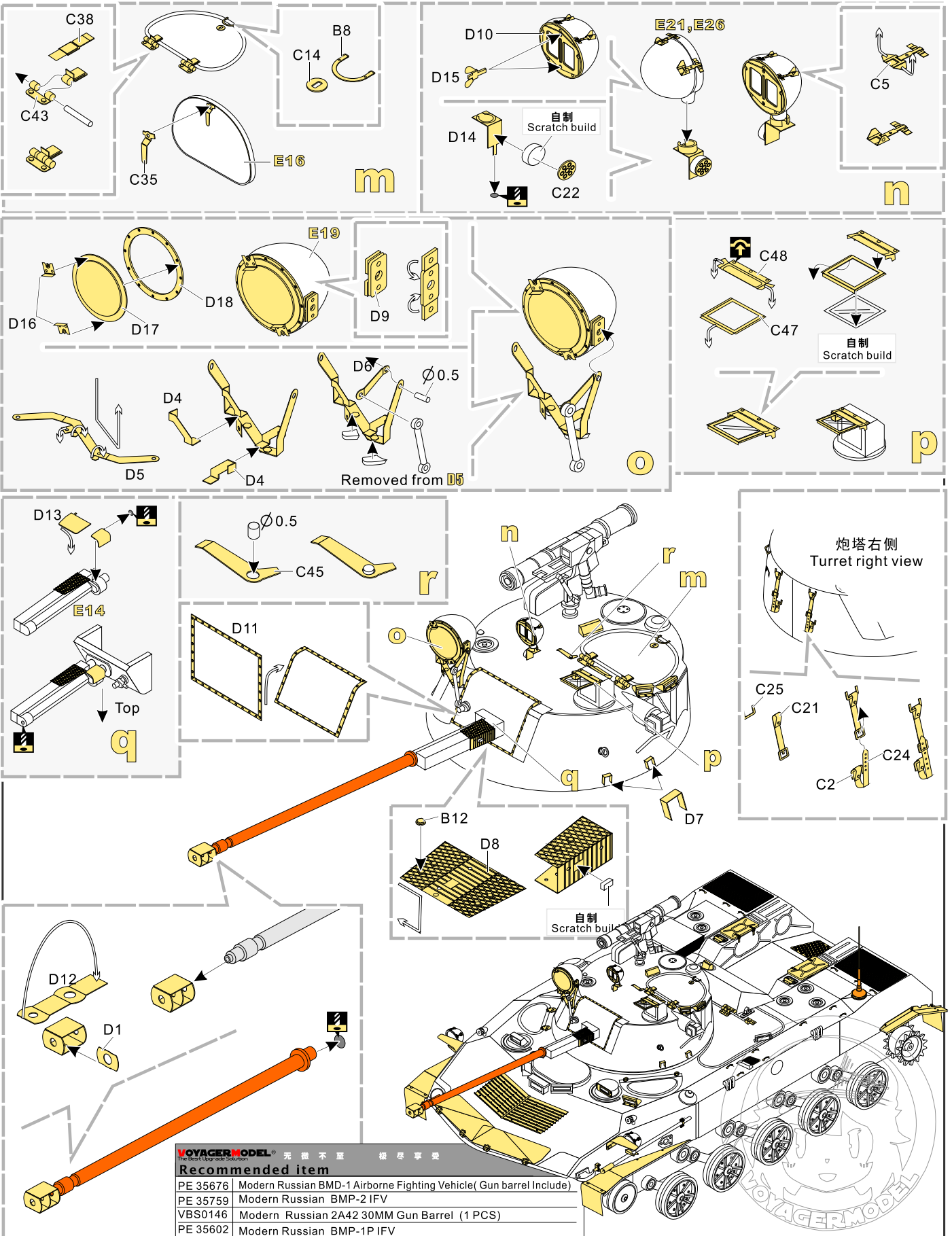

VOYAGERMODEL[®] 无微不至 极尽享受
The Best Upgrade Solution

Recommended item	
PE 35676	Modern Russian BMD-1 Airborne Fighting Vehicle(Gun barrel Include)
PE 35759	Modern Russian BMP-2 IFV
VBS0146	Modern Russian 2A42 30MM Gun Barrel (1 PCS)
PE 35602	Modern Russian BMP-1P IFV