



# Pkw.K1 KÜBELWAGEN (Type 82)

1/48 Scale German Panzertruppe Series No.3

1. This is an accurate 1/48 scale model of the Pkw.K1 Type 82 KÜBELWAGEN.
  2. This is the first mini model series that has detailed interior with engine cockpit.
  3. Complete instructions are enclosed for assembling the model kit. Also included in the historical summary on this vehicle.
- It is well known in the world that this Kubelwagen was used for scouting and communication by the German Army, and acted great part for military action. kübel means a tub or a bucket in German.



PIN POINT SERIES

**BANDAI CO., LTD.**

5-4 Komagata 2 chome  
Daitoku · TOKYO · JAPAN

## 《Instructions for Assembly》

- ★ Study carefully the assembly guide thoroughly before assembling the kit.
- ★ You can enjoy the big scale power with this handy mini-scale kit.
- ★ Paint each part.

## 《Parts List》

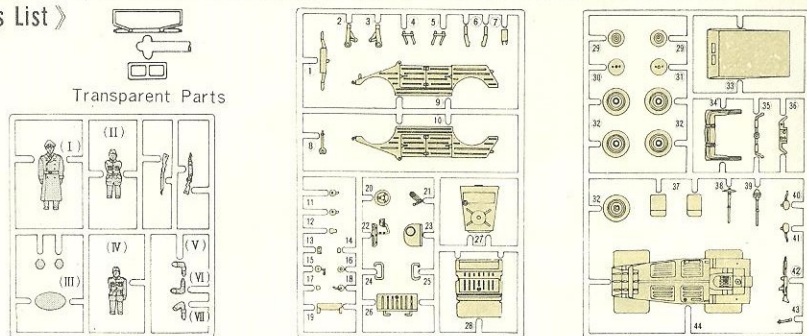

## 《Illustration 1: Wheel Fixing》

- ★ Assemble the rear wheels and the exhaust pipes and cement them to the chassis.
- ★ Paint each part.

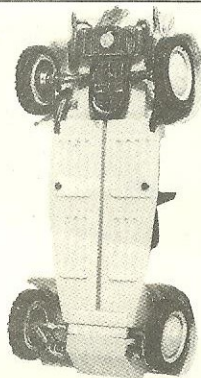
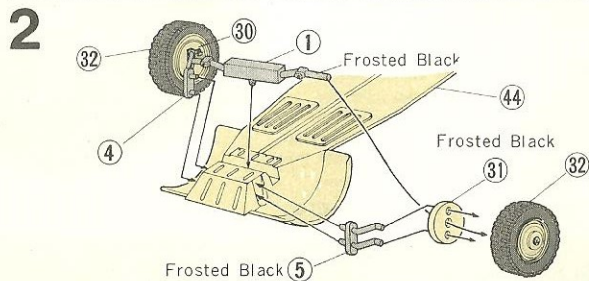
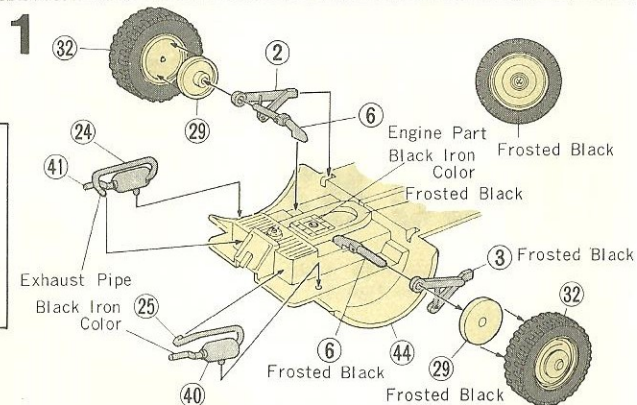
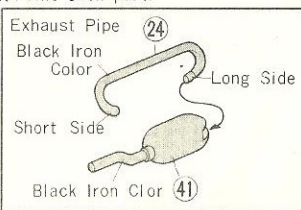

## 《Illustration 3: Engine Fixing》

- ★ Paint the parts.

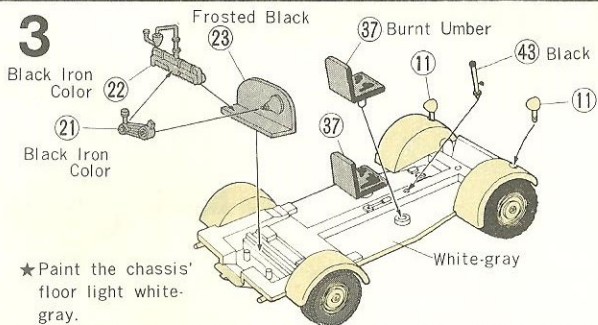
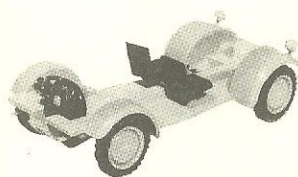

- ★ Paint the chassis' floor light white-gray.

## 《Illustration 4: Body Assembly (A)》

- ★ Paint the inside of the body light white-gray.
- ★ Assemble the engine-hood to be able to be open and close.
- ★ The inside of the body is light white-gray.

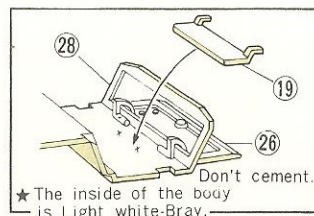

## 《Illustration 5: Body Assembly (B)》

- ★ Fix each part to the body. Paint them.

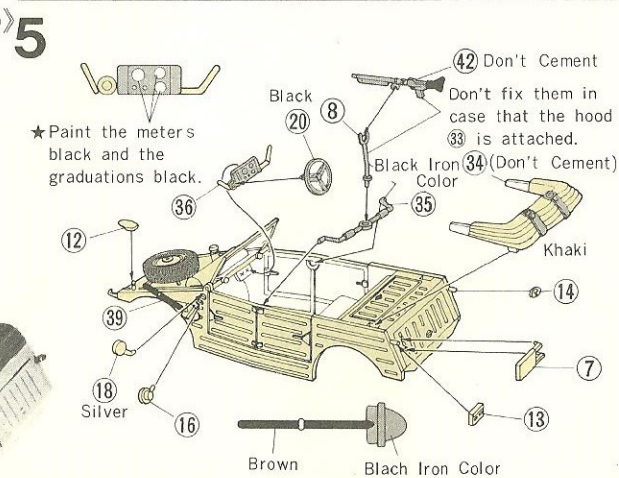
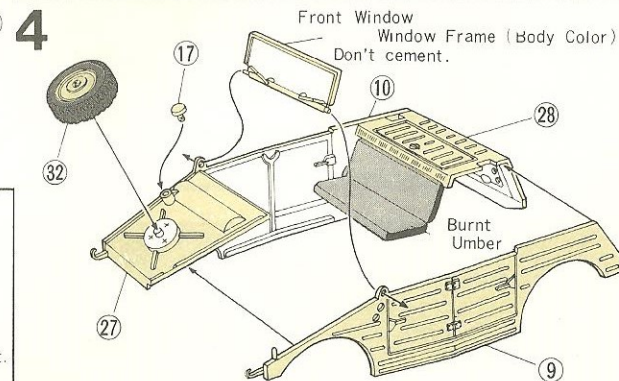
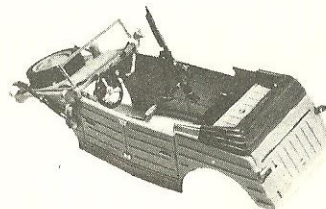
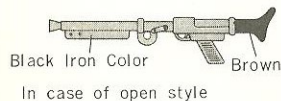

## «Illustration 6: Perfection»

★Cement the body to the chassis.

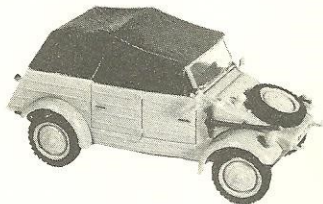

In case of the hood attached

# 6

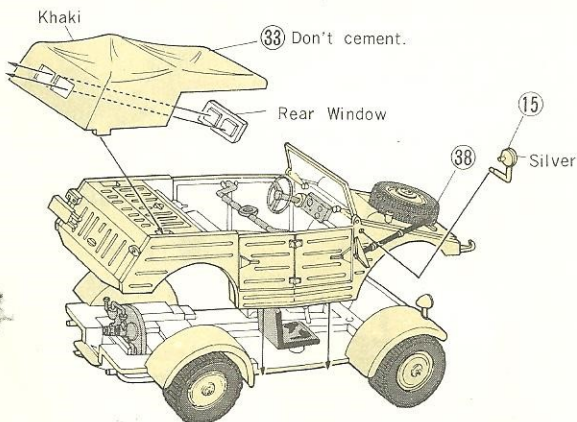



## «Explanation of the Decals.»

# 7





- G** A car belonged to the tank group commanded by General Güderian.
- K** A car belonged to the tank group commanded by General Krist.
-  A car belonged to the tank group commanded by General Rommell.

## «Divisions' Decals.»

-  No.1 Tank Division
-  No.1SS Tank Division
-  No.12 Tank Division
-  No.15 Tank Division

 Gros Deutschland Tank Howitzer Division

## «Car Discrimination Decal.»

-  A car of the mechanized infantry corps
-  A car of the antitank gun traction corps
-  A car of the autobicycle infantry corps
-  A car of the mobilization infantry company

## «Body Number»

1. 2. 3. 4. 5. 6. 7. 8. 9. 0

## «Car registration Decal.»

WH 157398	National Defence Army	WH-157398
--------------	-----------------------------	-----------

§§ 321654	Body- Guards	§§-321654
--------------	-----------------	-----------

★Stick the decals. at your option.

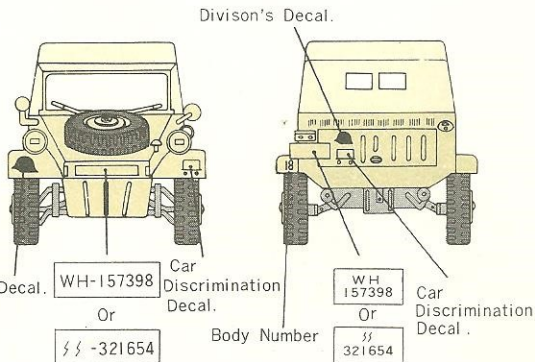

## 《Illustration 8: Doll Assembly》

- ★ Assemble the dolls and paint each doll.
- ★ Put the dolls on the car.

《In case of wearing the helmet.》

Scrape off this part.

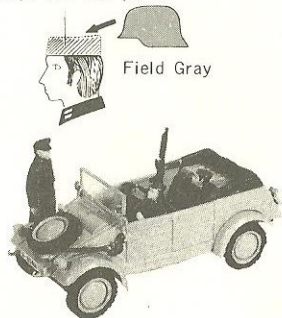

# 8

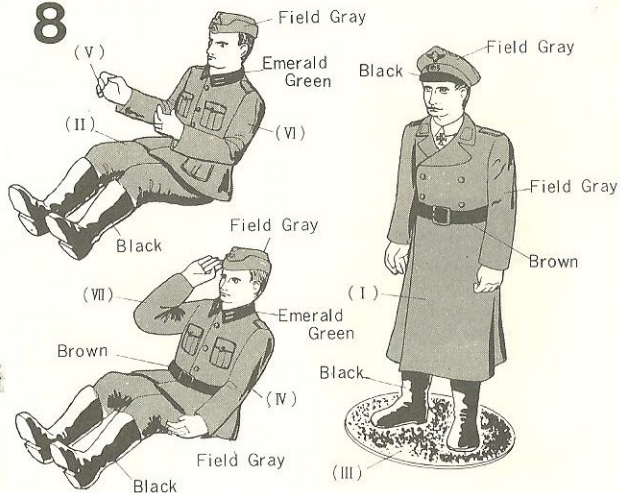

## 《The story of the Kubelwagen》

The national car (Volkswagen) that was developed for the purpose of "a car for every home" that was pledged by Hitler himself, was the prototype of this car. Hitler's promise, however, didn't come true, but the durability and the economy of this car drew the attention of the military authorities from its early stage, and at the same time of the beginning of the war till the defeat through the period, it was used as the foot of the German Army at Norway in the north, at the Eastern Battle Line raging snow-storm in the east and burning desert of Africa in the south. As same as the jeep of the Allied Force, in the battle scenes of movies or television programs in which the German Army appears, this car is the essential leading actor. This Kubelwagen was not changed its style from the appearance till the final, at least. But there were some varieties which were adjusted for various climate and natural features of every battle line as the one attached balloon tires for the desert, and the one attached caterpillars for experimental purpose to make a half truck, and some armored variations loaded 37mm guns were developed. And it is known that for the operations of rivers and swamps, the Schübeamwagen was developed as the amphibian truck. This was the type PKW-1/20.

Length...3.74m    Engine...aircooled, flat 4 cylinders, 4 cycle  
 Width...1.60m    1131 c.c.,    25 HP/3000 r.p.m.  
 Height...1.65m    Transmission...forward 4 speeds, rear 1 speed  
 Kubelwagen... Schübeamwagen

Maxim. Speed...80km/h  
 Seating Capacity...3-4 men



《 KÜBEL WAGEN 》



《 SCHÜBEAM WAGEN 》

## 《How to make 1/48 diorama model》

### 《No. 3: The expressions of leaves》

The diorama becomes vivid by attaching leaves to dead trees. By using these materials as shown right, cast about for the expressions of leaves. The below illustrations are the way of making leaves by utilizing a dishcloth gourd. And if a sponge is utilized, cut it as small as possible.

- ① Soak a dishcloth gourd in water till it is softened.
- ② As the loofah has been softened, unfix and cut it in small pieces.
- ③ Apply the Bond for woodworks on branches.
- ④ Dye these pieces green and stick them to the branches.



Dishcloth Gourd



Sponge



Sawdust

★ These materials are used for leaves generally.

