

IAF CH-53 Yasur 2000 & 2025

1/48

IC 48056

The set is a conversion and upgrade set for the Revell CH-53G kits. It will give you all you need to build a "Yasur 2000" or "Yasur 2025" or an earlier version of the Israeli heavy assault helicopter.

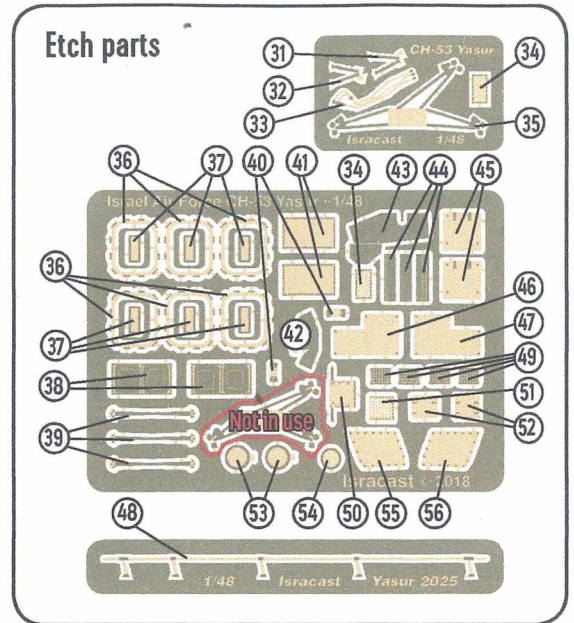
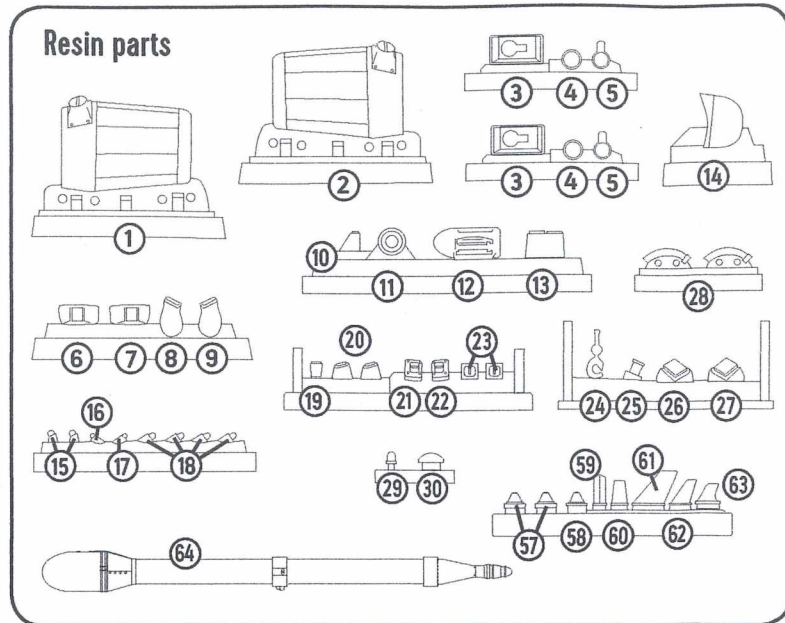

Add wires on the refueling probe.

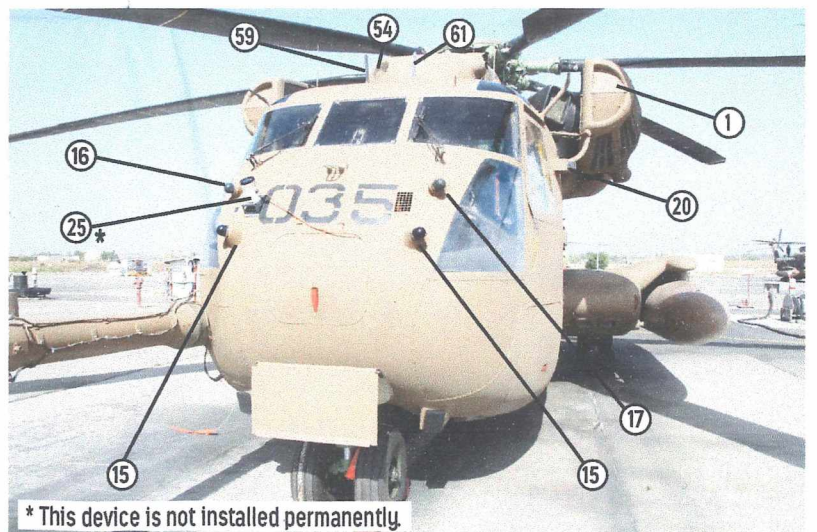
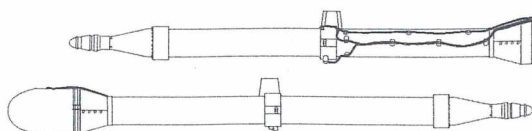
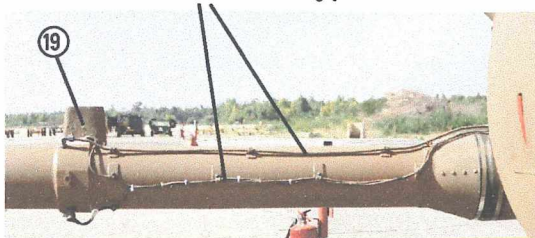

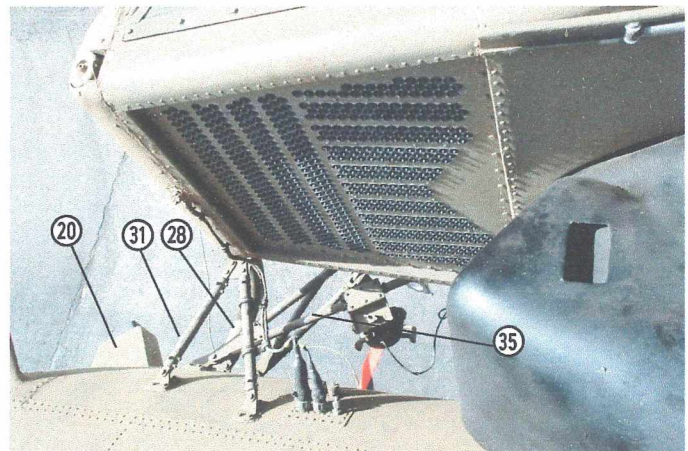
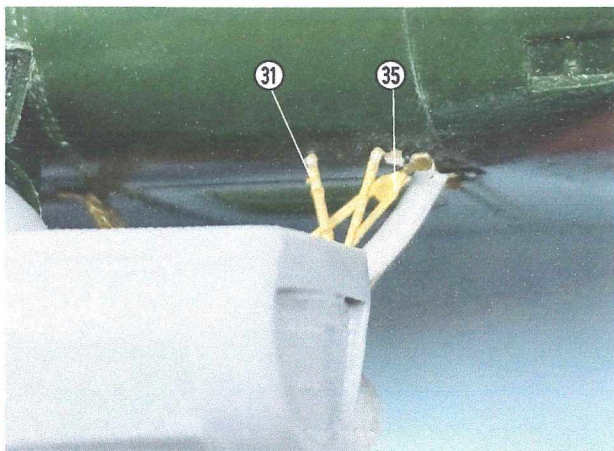
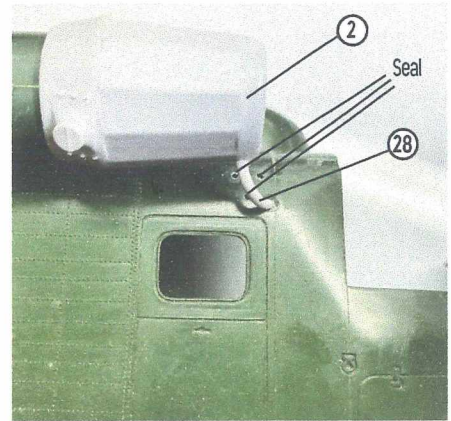
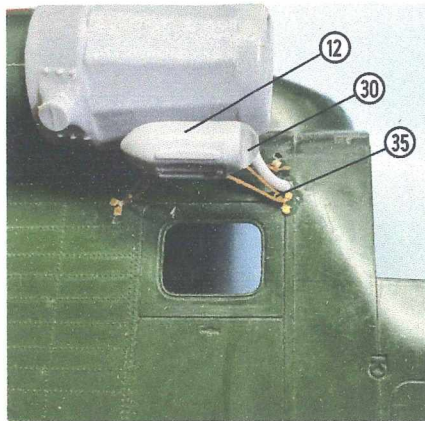
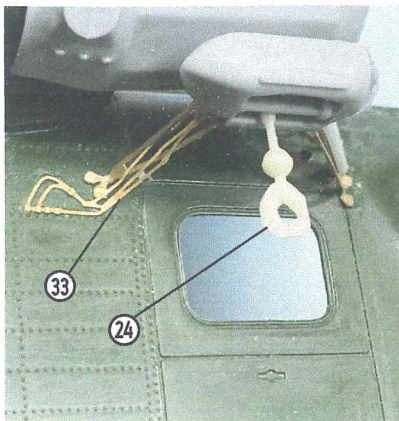
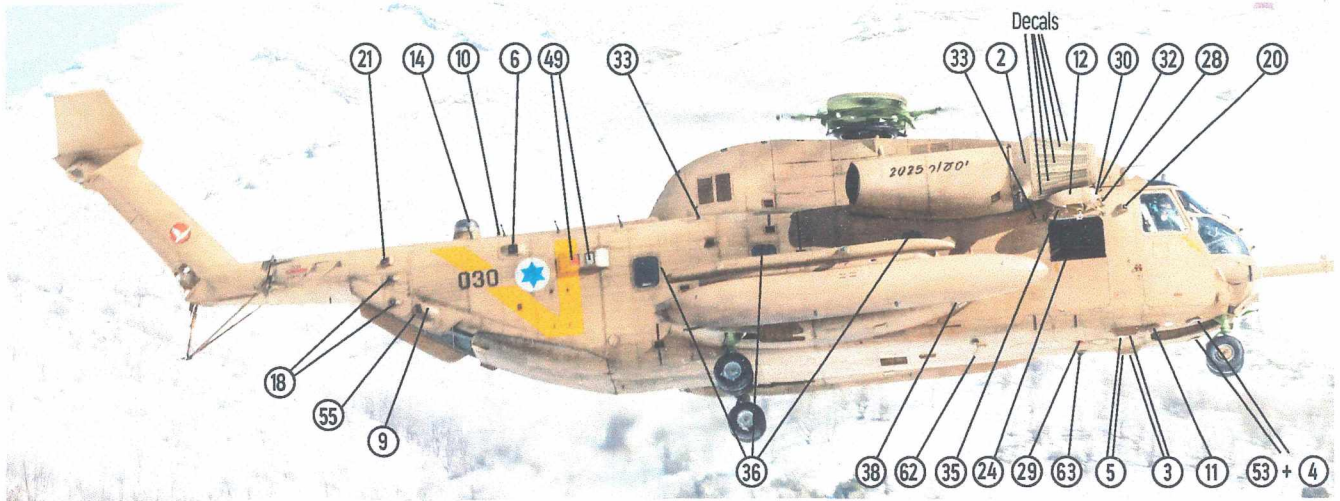

After installing the new filters, attach parts number 28 between the fuselage and the filters. Now attached each parts number 31 (32 on the other side). For the crane structure, fold part number 35 and attach it to the fuselage. Glue clear resin part number 30 to the crane part number 12. Attach part number 24 to the crane.

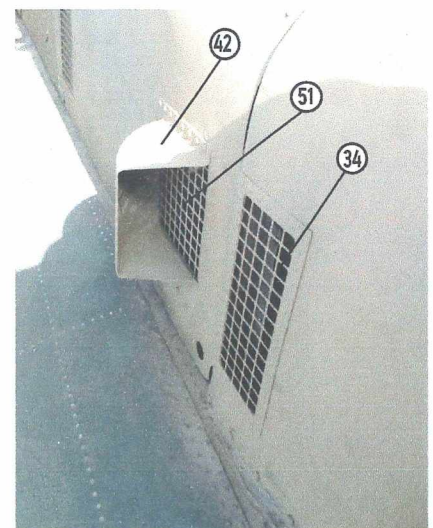

Yasur 2000 had an armour plates installed on several panels covering the main rotor systems. These external plates were removed when the helicopters were upgraded to Yasur 2025. The plates were installed on both sides.

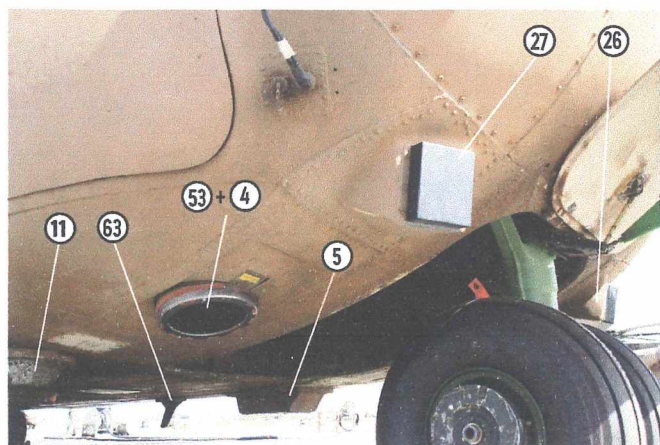
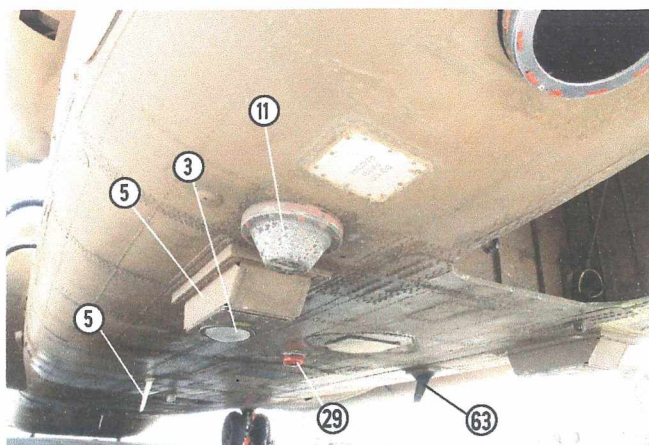
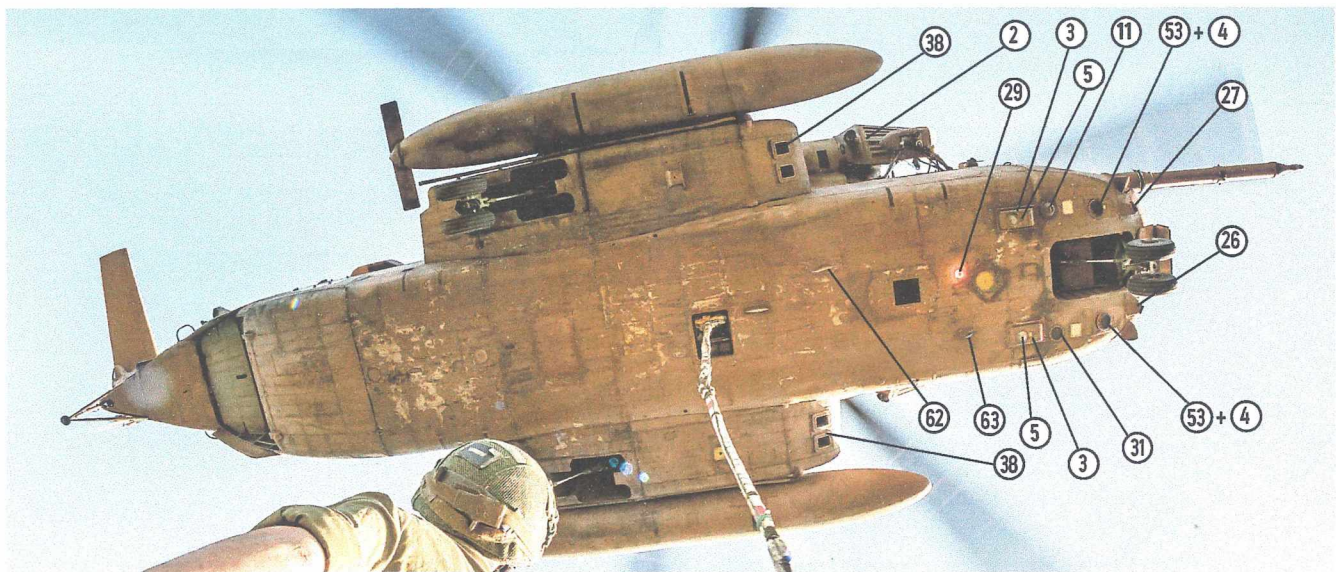
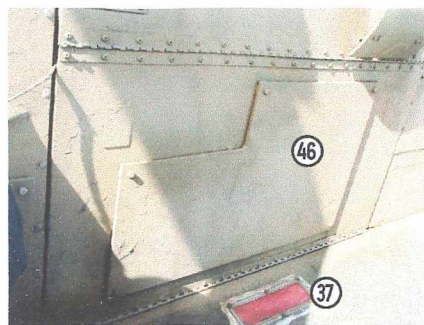
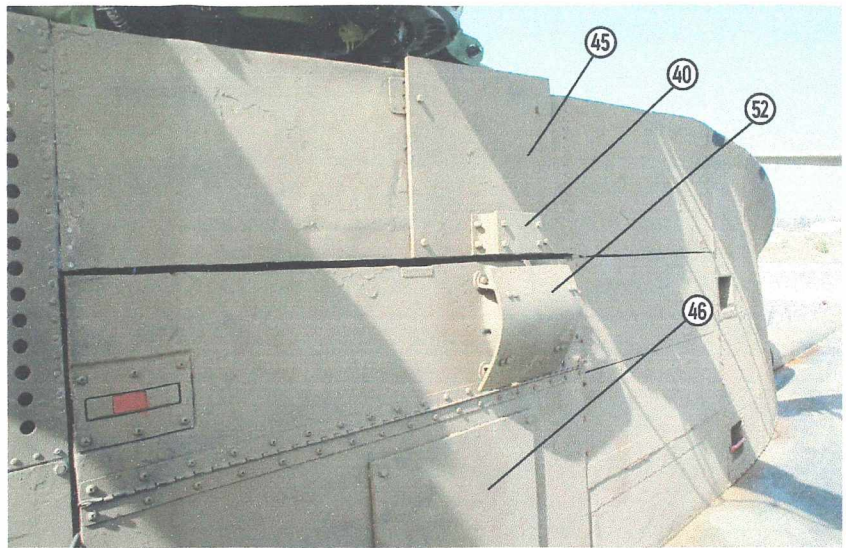

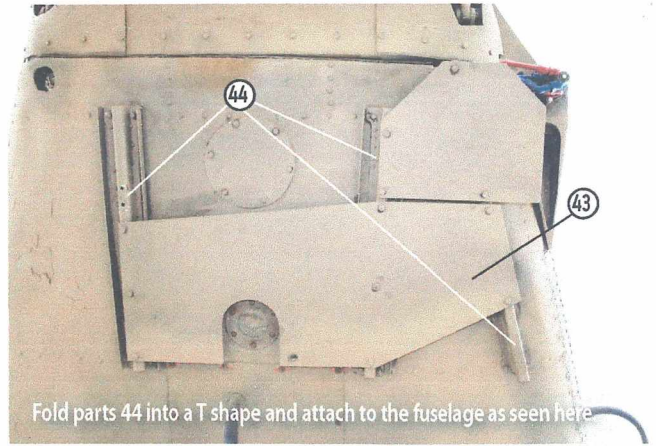

Fold parts 44 into a T shape and attach to the fuselage as seen here

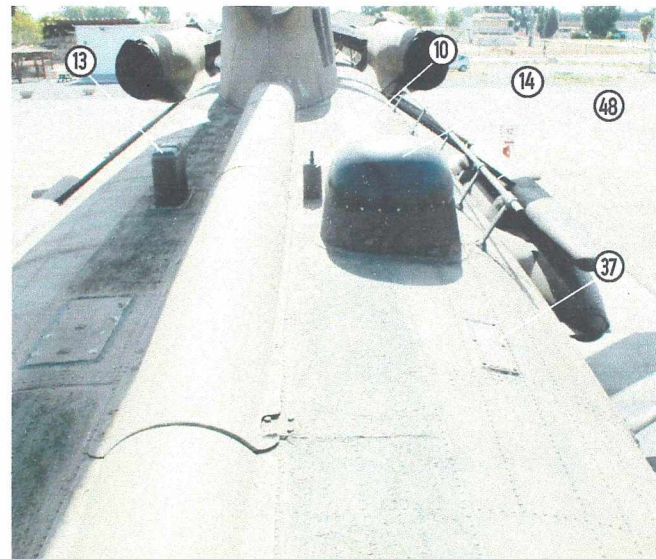
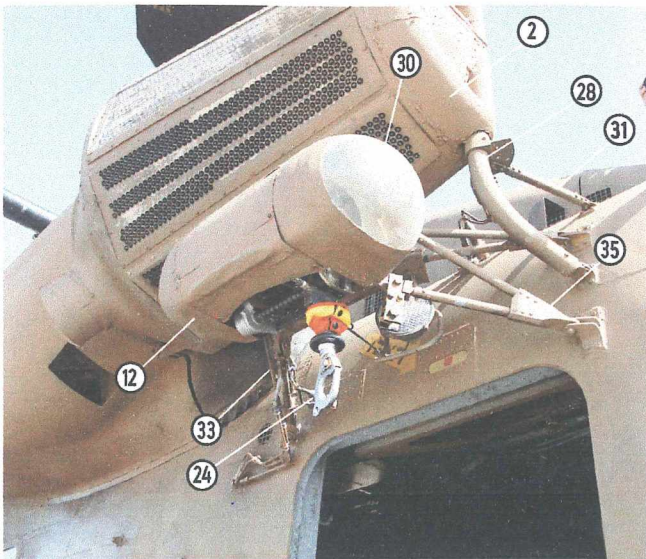
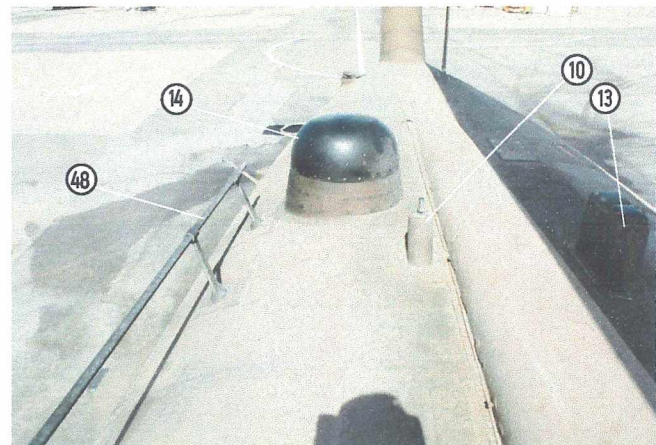
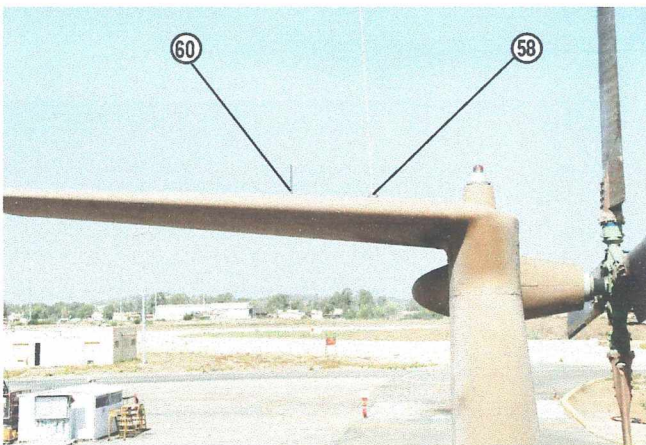
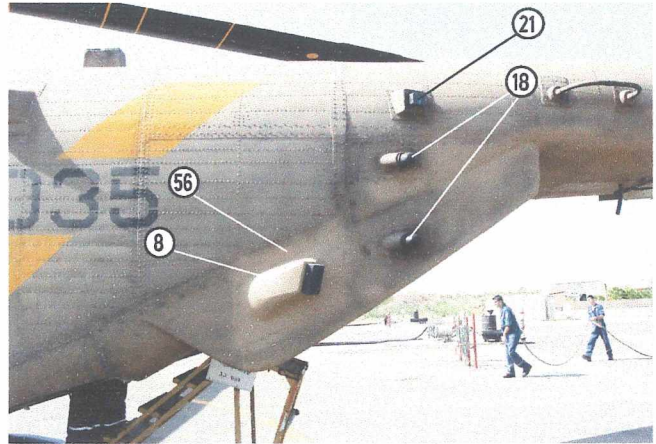
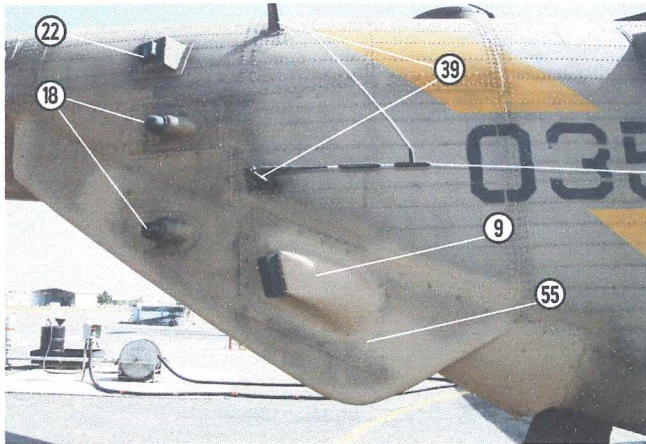

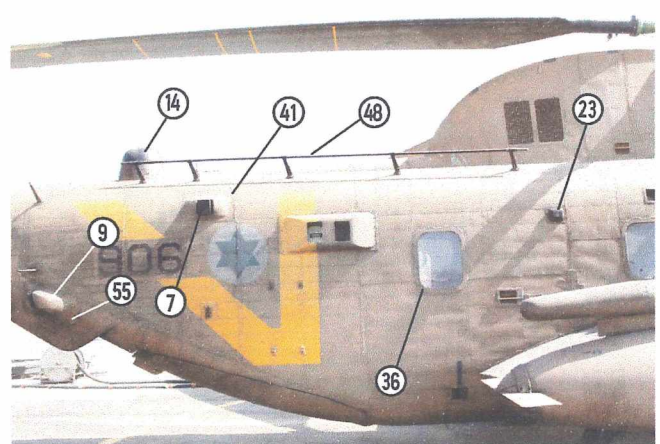
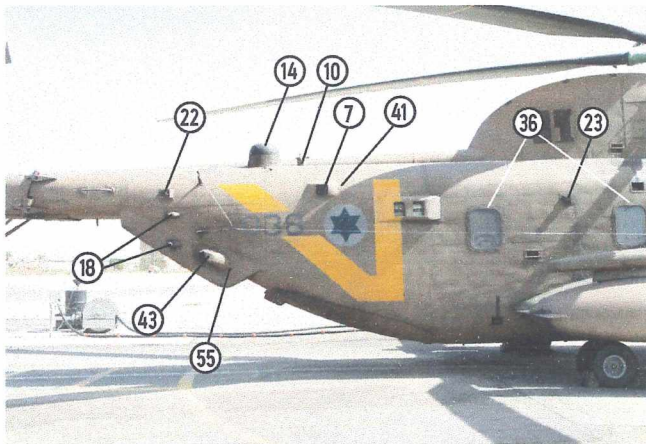
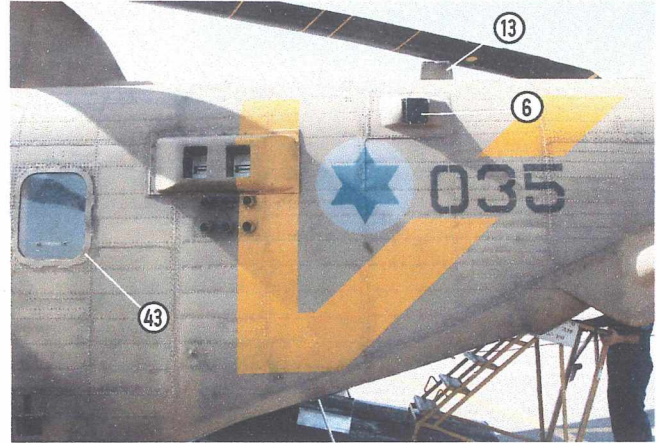
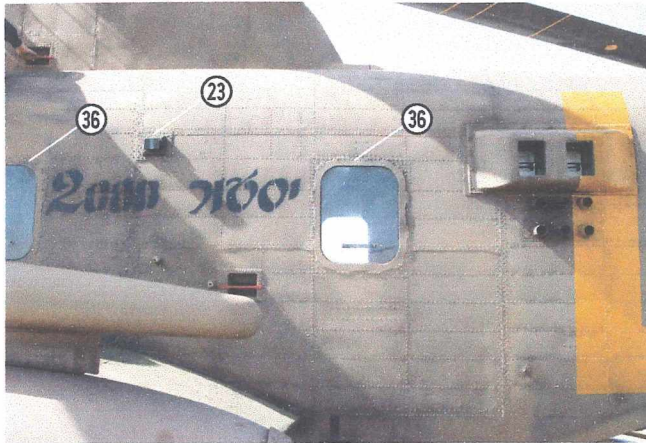
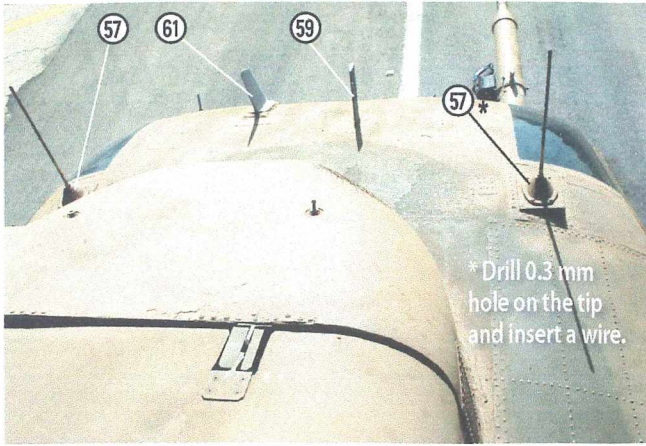

The CH-53 Yasur is in service with the IAF since 1969 and went through many installations and upgrades.

We provide decals in the set to allow you complete your Yasur 2000 or Yasur 2025.

The set provides also decals to model earlier Yasur configurations with different markings and scheme.

Check your references for the Yasur you wish to model or check and download the Yasur gallery PDF file from our website:

www.isradecal.com/instructions

