

BTL A-4 Y-Wing Starfighter

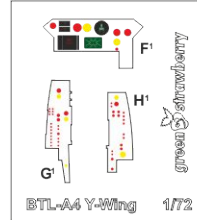
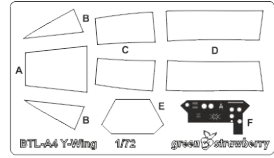
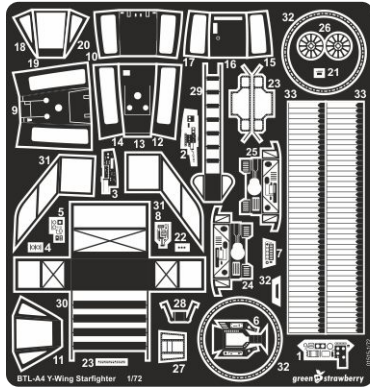

Tento výrobek obsahuje kovové detaily pro úpravu a vylepšení plastového modelu. Pro přesnou aplikaci kovových dílů může být zapotřebí přizpůsobit díly upravovaného modelu.

VAROVÁNÍ!

Tento set obsahuje malé a ostré díly. Pracujete ve větrané a dobře osvětlené místnosti. Doporučujeme použít ochranné brýle. Tento výrobek není vhodný pro děti mladší 14let.

This product contains metal detail parts for upgrading scale plastic models. When upgrading the model some cutting or corrections may be necessary for parts to fit accurately.

WARNING!

This set contains small and sharp parts. Work carefully in ventilated and well-lit room. Safety glasses are recommended. This product is not suitable for children 14 years or younger.

- remove odstranit**
- option volba**
- opposite side protější strana**
- bend ohnout**
- drill vrtat**
- grind brousit**
- fill vytmelit**
- PE part kovový díl**
- resin part resinový díl**
- decals part obtiskový díl**
- mask part maska díl**



greenstrawberry

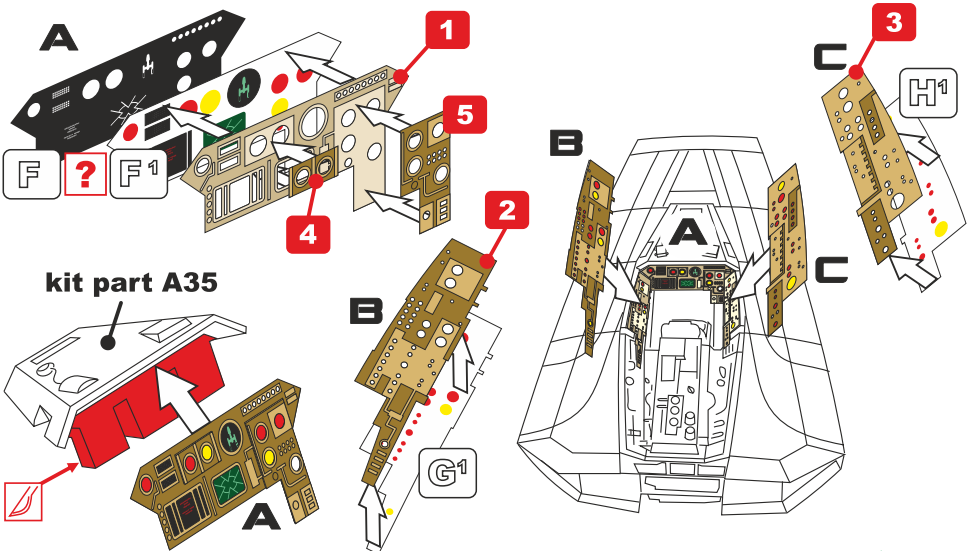

2

greenstrawberry

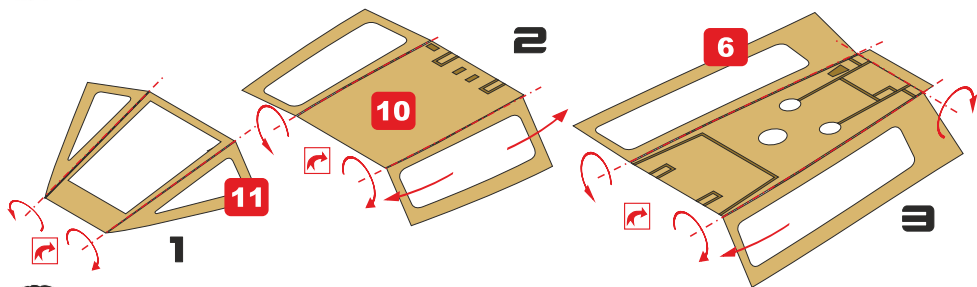

3

greenstrawberry

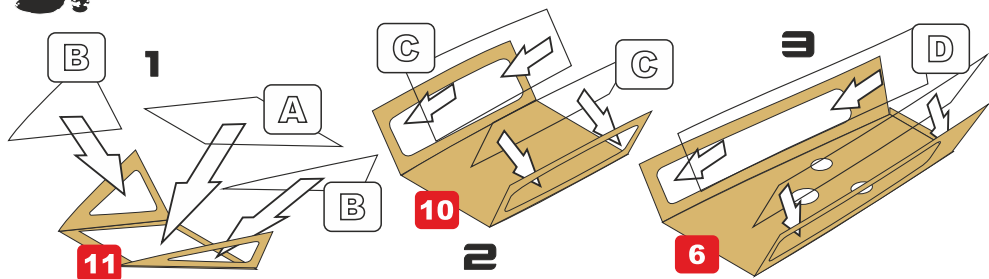

4

greenstrawberry

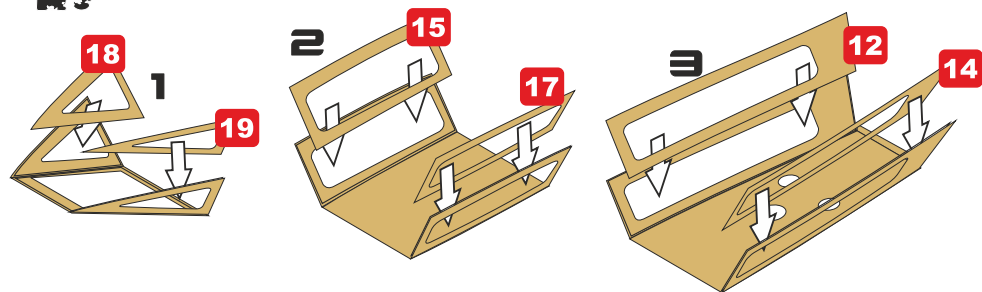

5

greenstrawberry

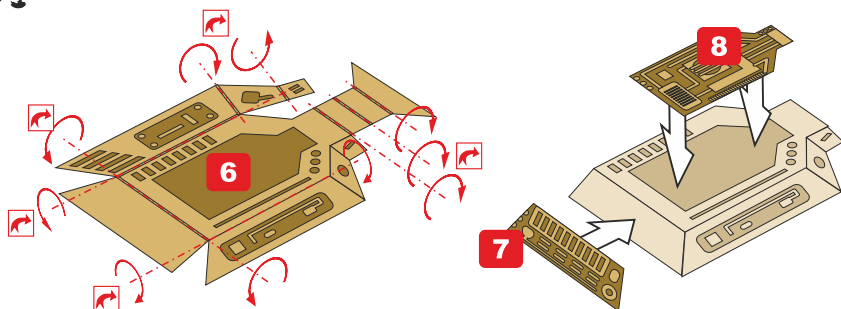



1

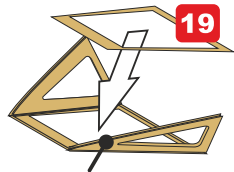

step 4.1
krok 4.1

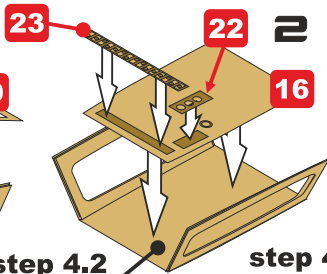

step 4.2
krok 4.2

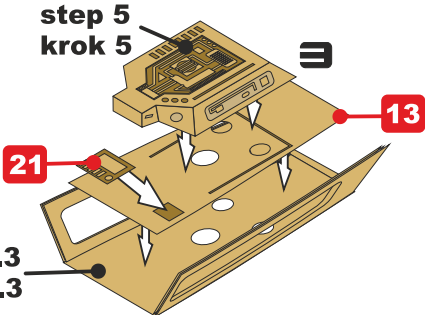

step 4.3
krok 4.3

step 5
krok 5



27

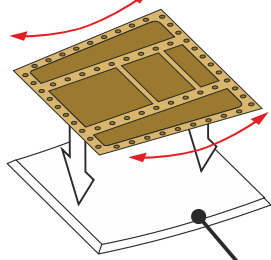

kit part B2 23

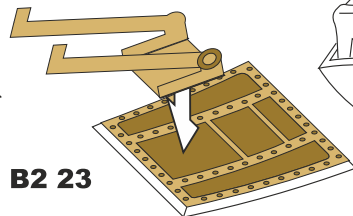
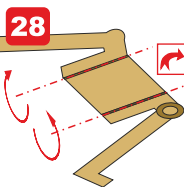

kit part B2 28&29

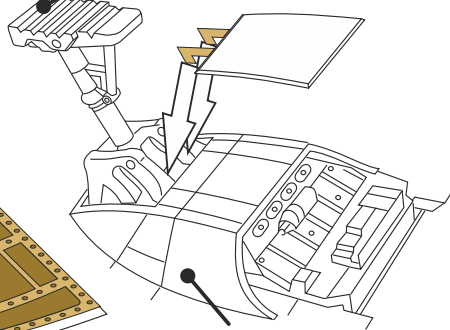

kit part B1 13



2x

24

25

1

25

24

24

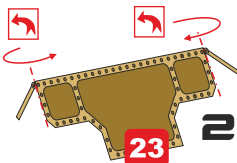

23

2

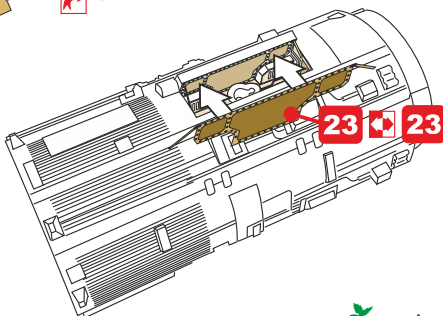
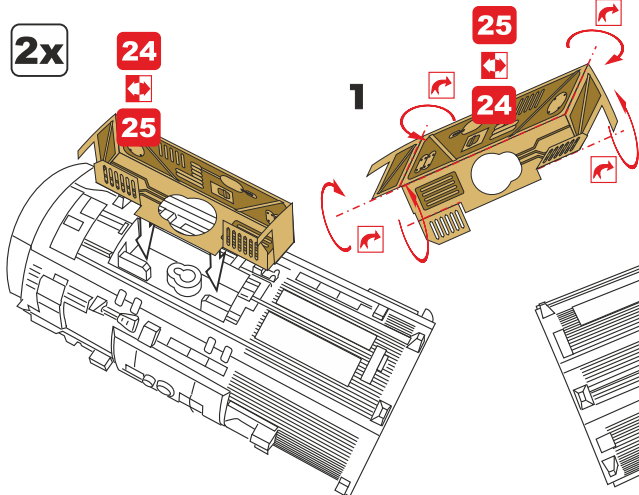

23

2x

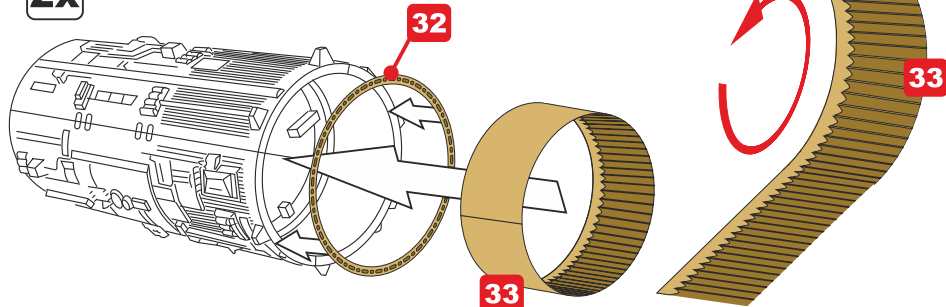

step 6.1
krok 6.1

step 6.2
krok 6.2

step 6.3
krok 6.3

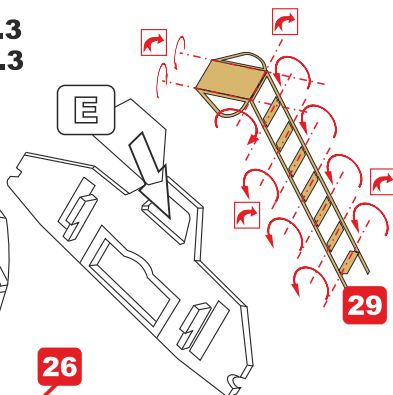
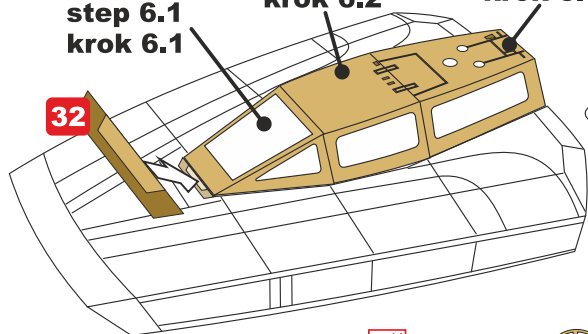

kit part A29.

kit part A28.

