

EagleCals
EC#78

□ 1/32

Fw 190 A-88

36 5, 36 54 & 36 301

eagle
EDITIONS LTD.

Hptm. Bazi Wei

"Small Black 10" Stab III./JG 54

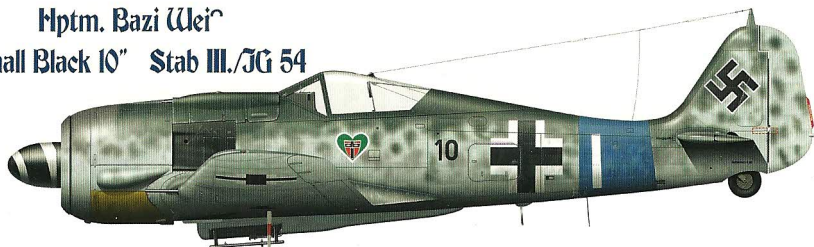

"Yellow 2" 9./JG 54



"Black 9" 1./JG 301

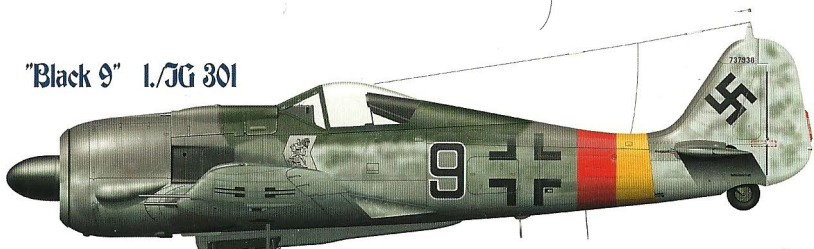

"Blue 8" 12./JG 5

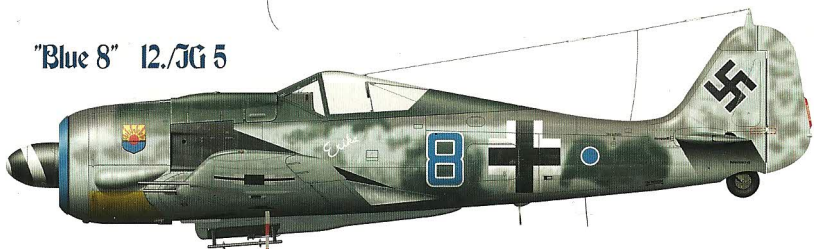

O1+O2+O3+O4 or P1+P2

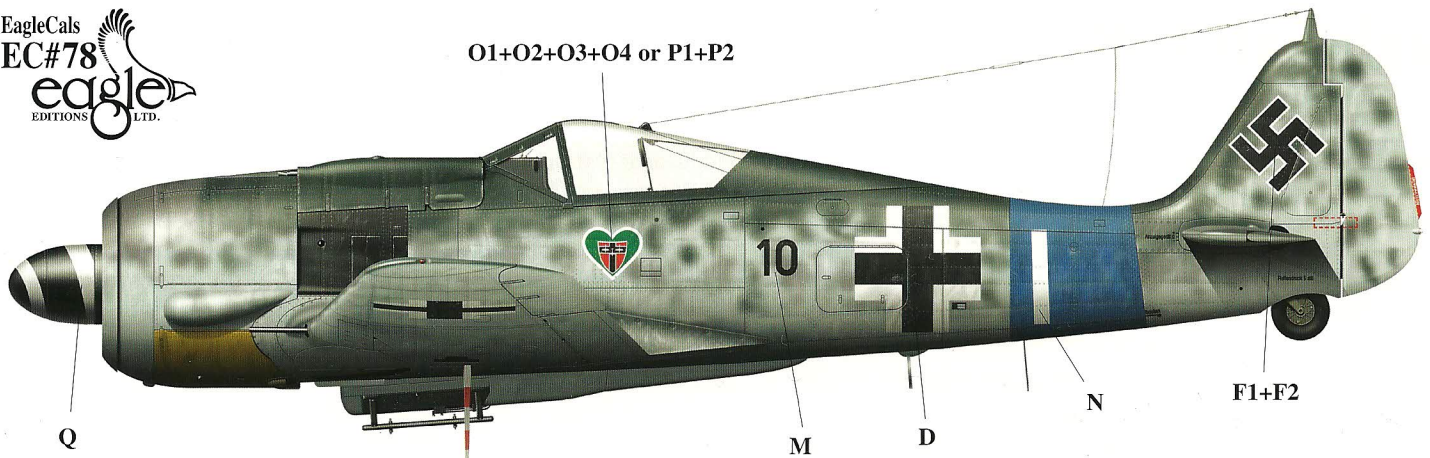

H1+H2+H3+H4 or I1+I2

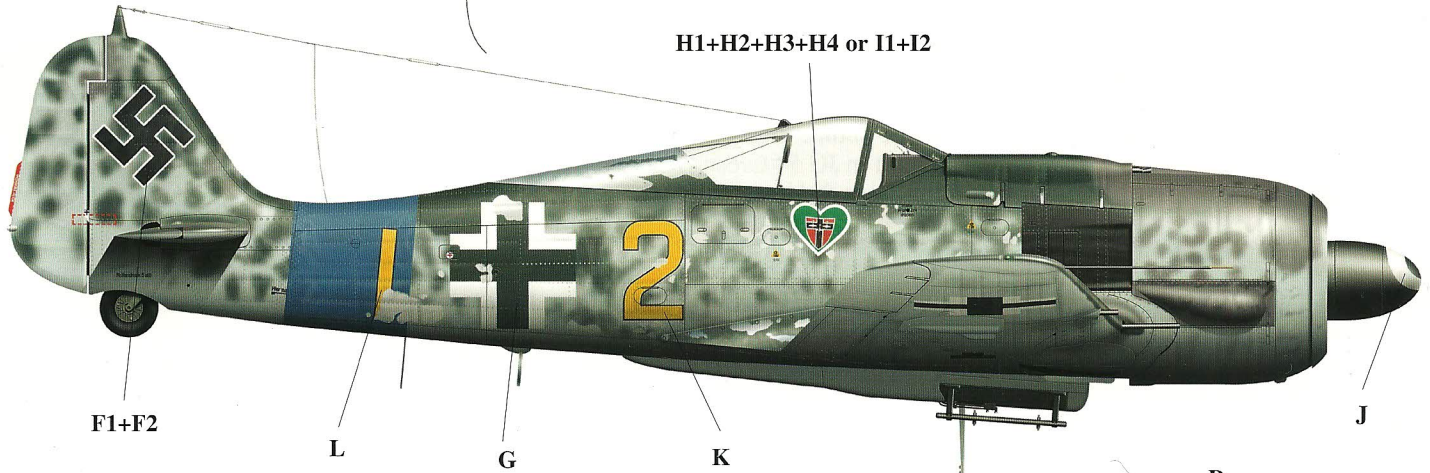

Note that alternate 'chipped' markings are provided.

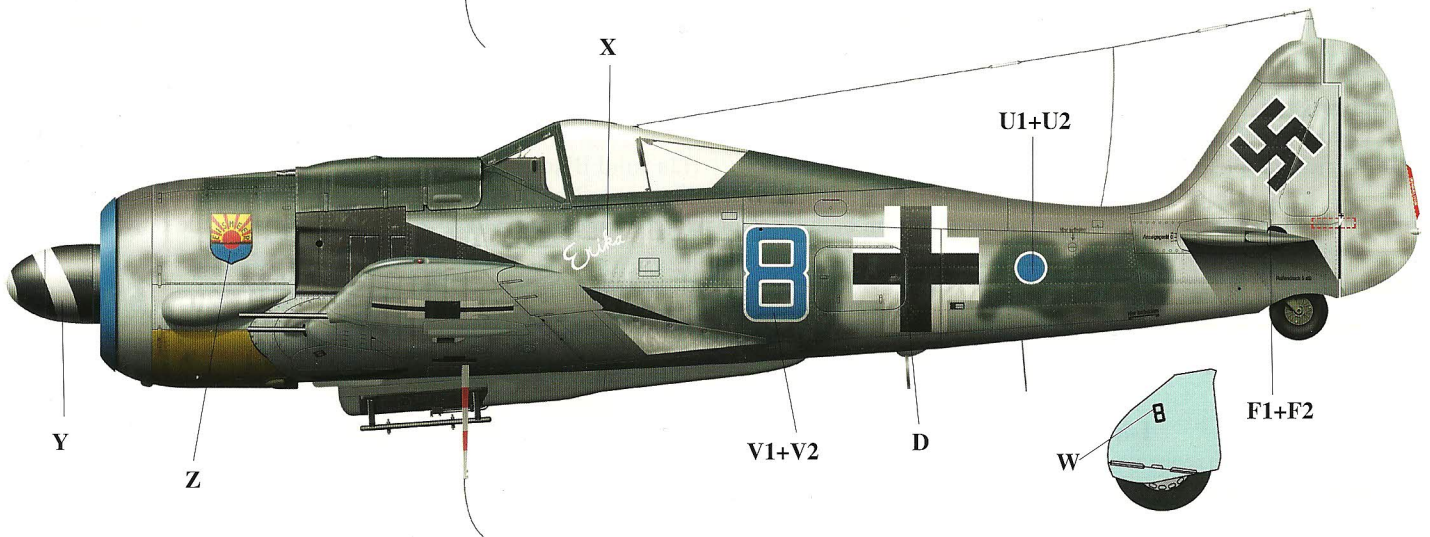
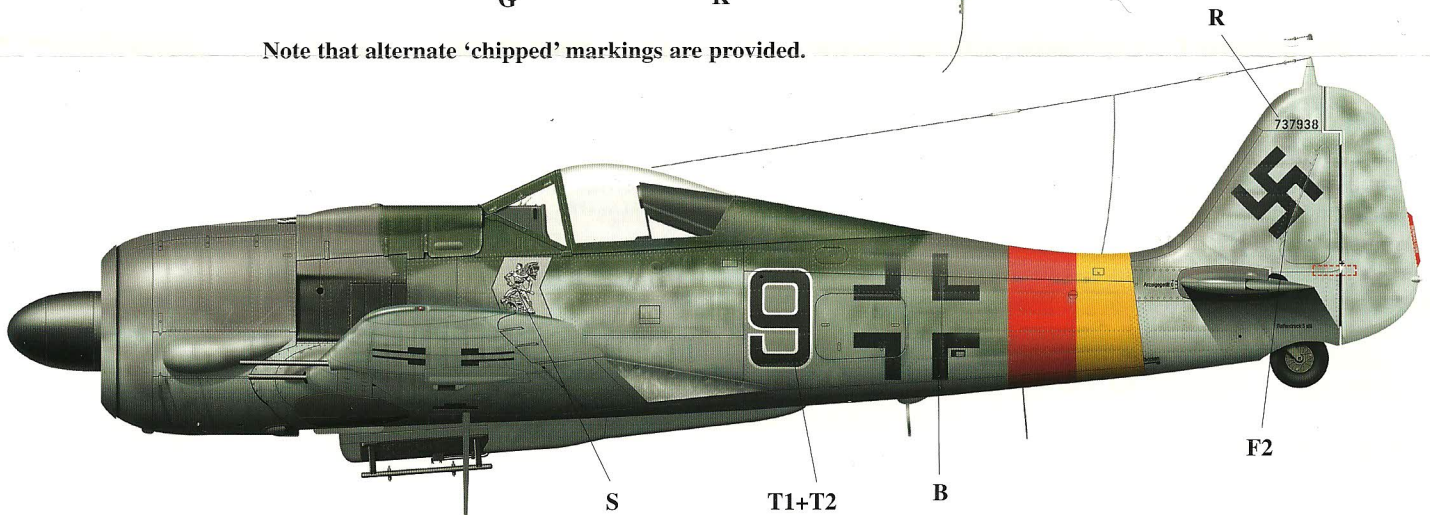

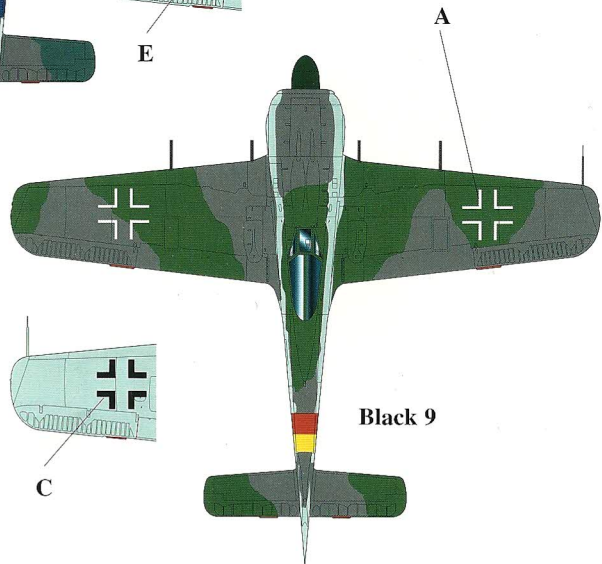
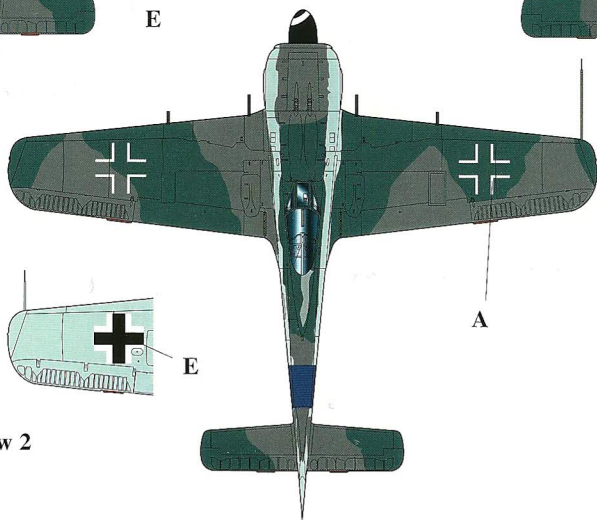
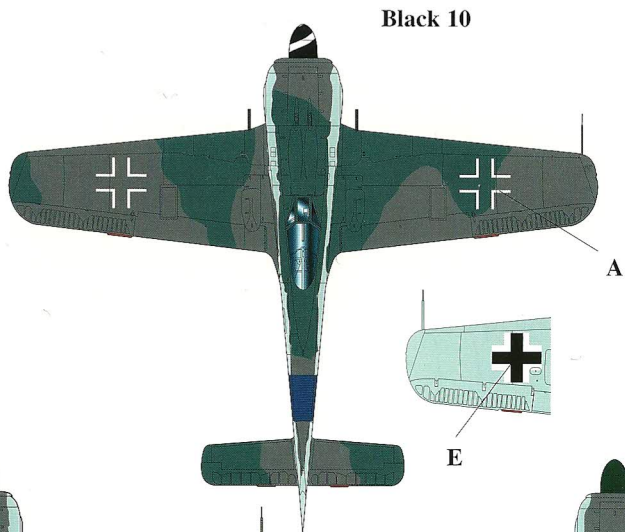
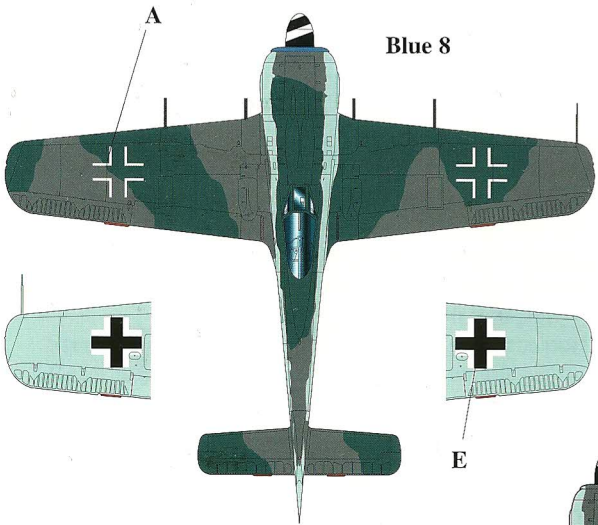

NOTE: Stencil diagram drawings are representational only. Check your references for the specific details and differences between variants.

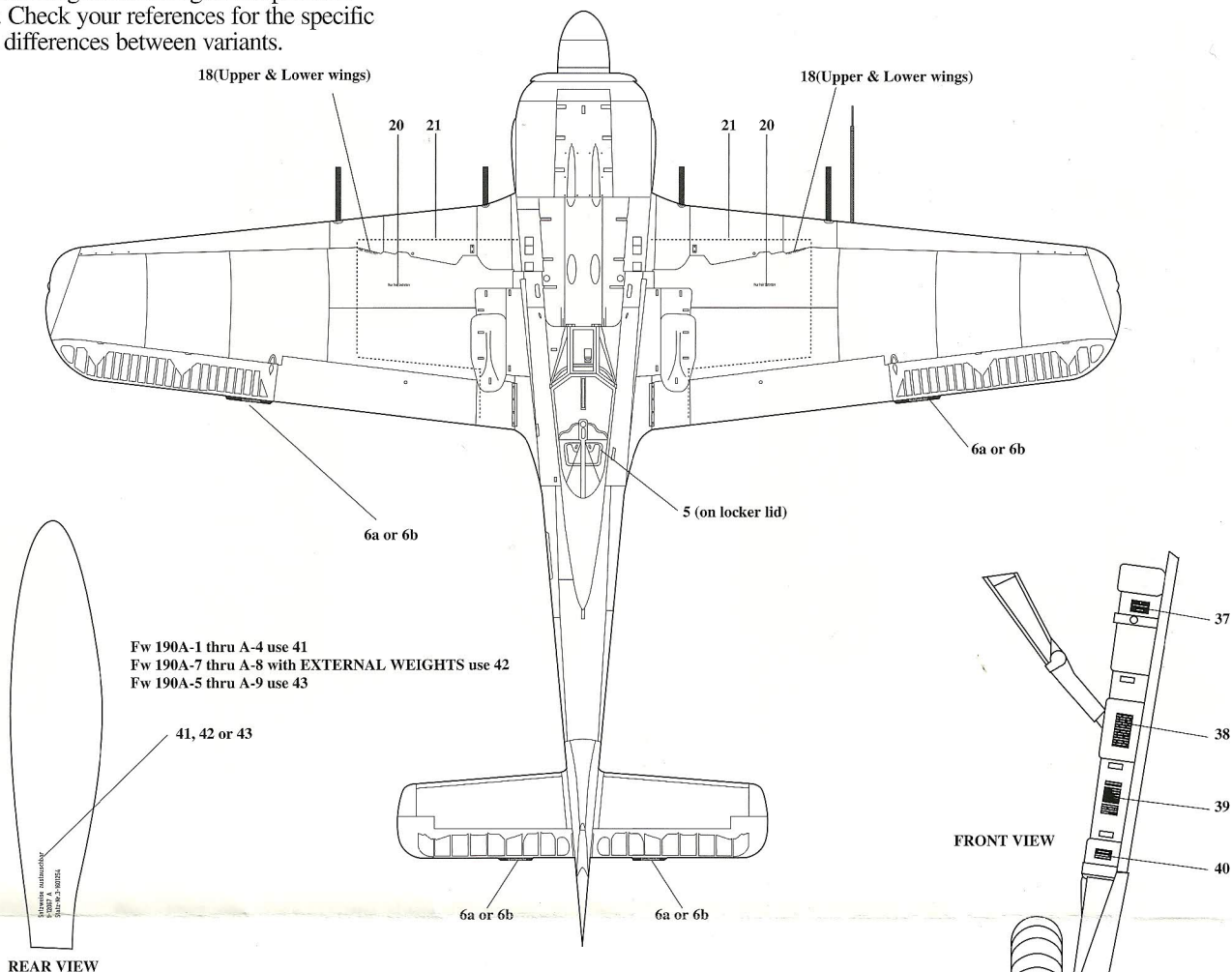

Fw 190A-1 thru A-4 use 41
 Fw 190A-7 thru A-8 with EXTERNAL WEIGHTS use 42
 Fw 190A-5 thru A-9 use 43

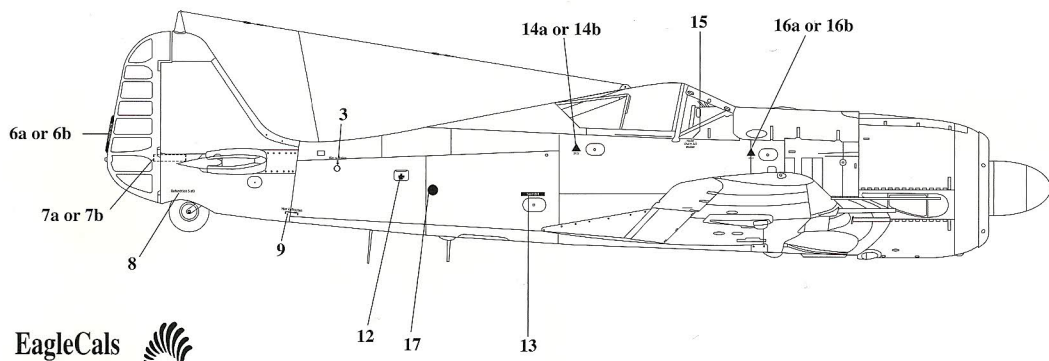
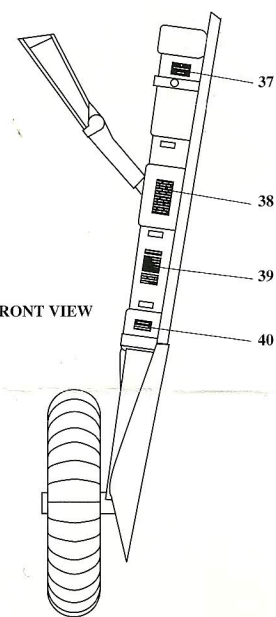

Propeller drawings are provisional-not to scale
 Common 9-12067A Metal



9-12153A Metal with external weights



Wooden 9-12176A

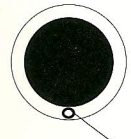
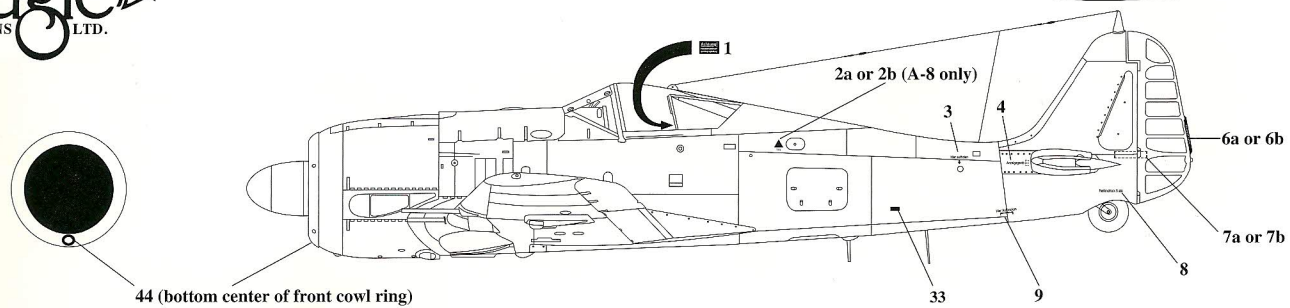

Stencils no. 22 thru 32 not used on Fw 190A aircraft.

EagleCals EC32-78 © 2004 Eagle Editions Ltd.

Custom decal and instruction art by Thomas A. Tullis

EagleCals #78

Fw 190 A-8s JG 5, JG 54 and JG 301

Decals designed for the Hasegawa 1/32nd Fw 190 A-8 kit ST-21. For additional National Markings decals, **EC#49-32** is recommended. In order to enhance the Hasegawa 1/32 Fw 190 A-8, we suggest adding the series of **EagleParts** resins designed specifically for this kit. Aftermarket items available include, main wheels and tires with the correct tread (**EP#48-32**), corrected gun cowl (**EP#49-32**) and corrected propeller blades with accurately shaped spinner. Choose from three propeller styles, **EP# 45-32**, the common 9-12067A metal propeller that is included with the kit but not quite accurate; **EP#46-32**, 9-12153A with external weights; or **EP#47-32**, 9-12176A larger wooden paddle blade propeller. Each set of propeller blades comes with a spinner. Listed below are the proper propellers for each aircraft.

“Small Black 10” Hptm. Robert “Bazi” Weiß Stab III./JG 54 June 1944 Villacoublay, France

This was the aircraft of the III. *Gruppenkommandeur*, Hptm. “Bazi” Weiß noted Knight’s Cross holder. Outboard MG 151 20 mm cannons deleted, but the upper wing fairings remain. All antennas intact. Common 9-12067A prop. This small Black 10 was also applied to his later Dora 9 and other aircraft in his *Stab*.

Colors: Undersurfaces; RLM 76 Light Blue; Uppersurfaces RLM 75 Gray-Violet, RLM 74 Gray-Green; Spinner Black with White spiral. Prop blades RLM 70 Black-Green. Appears to have Yellow undercowling. JG 54 Blue home defense band. Possible Red/White striped FuG 16 zy antenna mast. Black exhaust panel.

National Markings: Fuselage; B3, 800 mm Black and White crosses, H2a Black and White *Hakenkreuz*.

Wings: Upper - B6 910 mm White outline crosses, Lower - B3 900 mm Black and White crosses.

Stencilling: Factory Standard. III./*Gruppe* emblem inset in JG 54 Green Heart, both sides.

Reference: **Green Hearts First in Combat with the Dora 9**, Urbanke. Eagle Editions Ltd. 1997

“Yellow 2” 9./JG 54 May 1944 Illesheim, Germany

R2 outboard MK 108 30 mm cannon with underwing fairing and shell ejection port, and upper wing fairing. Common 9-12067A prop. A-7 long pitot tube in A-8 wingtip position. Paint is heavily chipped and worn. All antennas intact.

Colors: Undersurfaces; RLM 76 Light Blue. Uppersurfaces; RLM 75 Gray-Violet, RLM 74 Gray-Green. Possible Yellow under cowling. JG 54 Blue home defense band. Black exhaust panel. Spinner Black with White spiral, prop blades RLM 70 Black-Green.

National Markings: Fuselage: B3 800 mm Black and White crosses, H2a Black and White *Hakenkreuz*

Wings: Upper - B6 910 mm White outline crosses, Lower - B3 900 mm Black and White crosses.

Stencilling: Factory Standard. III./*Gruppe* emblem inset in JG 54 Green Heart, both sides.

Reference: **Green Hearts First in Combat with the Dora 9**, Urbanke. Eagle Editions Ltd. 1997

“Black 9” W. Nr. 737938 I./JG 301 Summer 1945 Germany

This aircraft is one of the machines turned over to JG 301 by JG 11 in the Spring of 1945. JG 11’s existing Yellow home defense band was left in place and the Red was added in front of it by JG 301 resulting in the Red/Yellow JG 301 bands being reversed from the normal application. There are other known photos of aircraft having similar markings. The existing JG 11 “Strong man” emblem was left intact. Armament configuration not known. Upper wing fairings intact. Blown canopy. The canopy from Hasegawa’s 1/32 D-9 kit can be used. All antennas intact. Common 9-12067A prop.

Colors: Undersurfaces; RLM 76 Light Blue. Uppersurfaces RLM 75 Gray-Violet; probably RLM 83 Dark Green. Mid-Gray seems to be lighter than normal. Spinner and prop blades RLM 70 Black-Green. Lower portion of exhaust panel Black. One photo shows a dark area on gun troughs which is not illustrated as it is inconclusive.

National Markings: Fuselage: B4 800 mm Black outline crosses, H3 All Black *Hakenkreuz*

Wings: Upper B6 910 mm White outline crosses, Lower - B4 900 mm Black outline crosses.

Stencilling: Factory Standard, JG 11 emblem port side only.

Reference: Photos, James Crow Collection

“Blue 8” 12./JG 5 February 1945 Herdla, Norway

All antennas intact. No pulley on canopy. Upper wing cannon fairings not visible. Common 9-12067A prop, provisional.

Colors: Undersurfaces; RLM 76 Light Blue. Uppersurfaces; RLM 75 Gray-Violet, RLM 74 Gray-Green; JG 5 Blue cowl ring. Spinner appears to be Black with White spiral however it could be Blue with White spiral. Yellow under cowling. Black design on exhaust panel and fuselage. Small “8” on landing gear doors.

National Markings: Fuselage; B3 800 mm Black and white crosses, H2a solid Black and White *Hakenkreuz*

Wings: Upper - B6 910 mm White outline crosses, Lower - B3 900 mm Black/White crosses.

Stencilling: Factory Standard. Blue IV *Gruppe* circle on both sides of rear fuselage. Name “Erika” on fuselage port side only. JG 5 emblem port side cowling.

Reference: **Focke Wulf Jagdflugzeug Fw 190 A Fw 190 Dora Ta 152 H**, Rodeike. Struve-Druck, Germany, 1998.

© 2004 Eagle Editions Ltd. All images/photos copyrighted by
Eagle Editions Ltd. P.O. Box 580 Hamilton MT 59840
1-800-255-1830 orders (406) 375-9270 Fax or (406) 363-5415 office

No copies may be reproduced without written consent from publisher Eagle Editions Ltd., and Artist Jerry Crandall

The color schemes depicted are the artist’s interpretations of the available photographic references only. The final decision resides with the modeller.