



# Royal Australian Air Force 2 OCU Last Classic Hornet 1985 - 2019



- A** Bright Orange  
FS-22473  
Match to colour  
chip provided
- B** Matt Linen  
Hum 74
- C** Light Ghost Grey  
FS-36375
- D** Medium Grey  
FS-35237
- F** Steel with a  
Clear Smoke  
over the top
- G** Polished  
Steel
- Gloss Black

**NOTE 5**  
When placing decal CPS and CSS  
on and down. Once the decal is dry  
Use a Sharp scalpaile to cut the decal  
along the canopy rail.  
**THE DECAL MUST BE DRY AND  
SET BEFORE HAND**

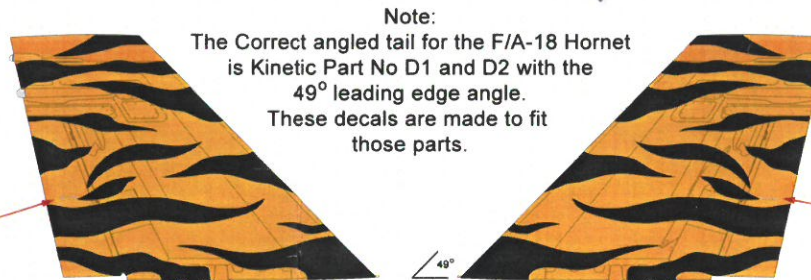

**NOTE 1**  
Corrected 1/48 RAAF F/A-18 Hornet Tails  
available for Hasegawa and Kinetic kits  
RCS-018

**NOTE 2**  
For all other data and panel number placements  
see larger Data and panel number Ins sheets

**NOTE 3**  
You will have to paint the Tail support  
angles Gloss Black

**NOTE 4**  
Before painting the Orange,  
You should paint the area white first.

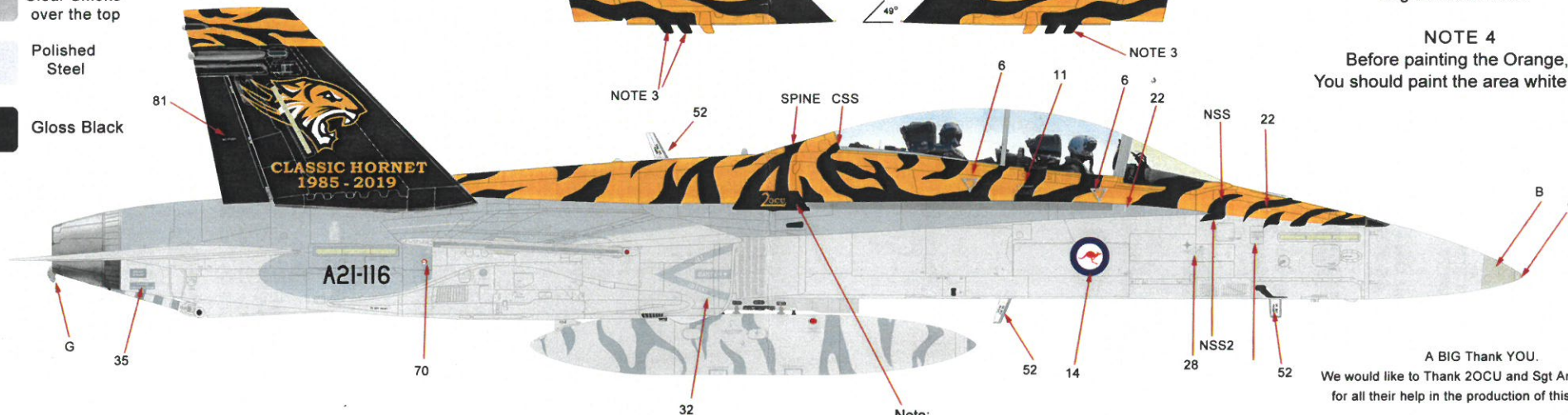

**Note:**  
Inside of LEX fences are painted  
gloss black.







**A BIG Thank YOU.**  
We would like to Thank 20CU and Sgt Andrew Green  
for all their help in the production of this decal set.





# TOP VIEW PAINT PLAN

# Royal Australian Air Force 2 OCU Last Classic Hornet 1985 - 2019

- A**  Bright Orange  
FS-22473  
Match to colour  
chip provided
- B**  Matt Linen  
Hum 74
- C**  Light Ghost Grey  
FS-36375
- D**  Medium Grey  
FS-35237
- F**  Steel with a  
Clear Smoke  
over the top
- G**  Polished  
Steel
-  Gloss Black

There is a thin medium grey line that goes in front of the gun port

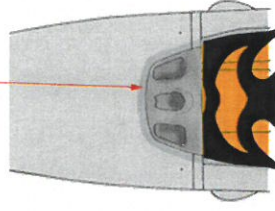

## NOTE 2

For all other data and panel number placements see larger Data and panel number ins sheets



## NOTE:

1. Start from the front and work towards the back.
2. When placing the spine Tiger stripes on, USE PLENTY OF SOAPY WATER to help you centre it on the spine.
3. Use the model panel lines to help guide you to the correct position
4. Then squeezing out the excess water.
5. Put Antennas on last.

1/48 & 1/32 Only  
On main Data Sheet

1/48 & 1/32 Only  
On main Data Sheet



**Note:**  
The Portside Horizontal Stab is painted in Medium grey but had faded to being very light. It also had fresh paint patches on it as shown below.

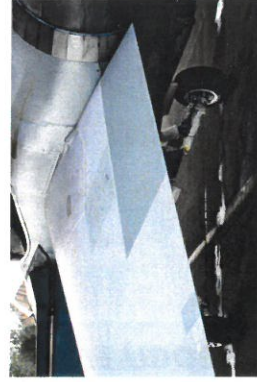









**NOTE 4**  
Before painting the Orange, You should paint the area white first.





# Canopy Paint Guide

Royal Australian Air Force  
2 OCU Last Classic Hornet  
1985 - 2019

- A**  Bright Orange  
FS-22473
- B**  Match to colour  
chip provided
- C**  Matt Linen  
Hum 74
- C**  Light Ghost Grey  
FS-36375
- D**  Medium Grey  
FS-35237
- F**  Steel with a  
Clear Smoke  
over the top
- G**  Polished  
Steel
-  Gloss Black

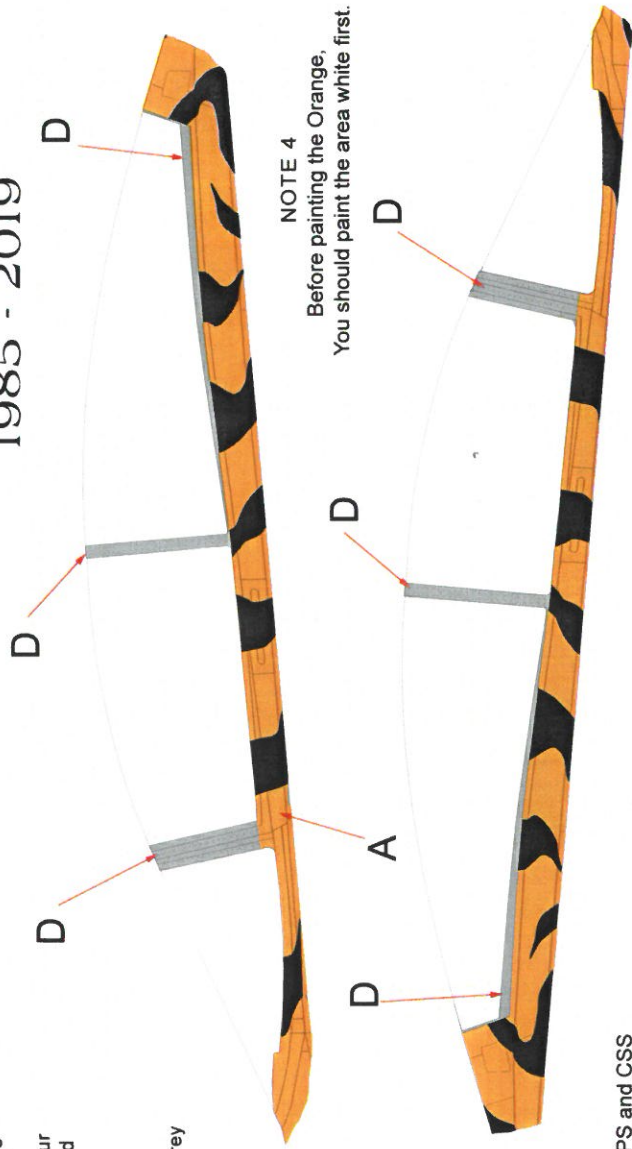

**NOTE 4**

Before painting the Orange,  
You should paint the area white first.

**NOTE 5**





When placing decal CPS and CSS  
you will have to do this with the Canopy  
on and down. Once the decal is dry  
Use a Sharp scalpel to cut the decal  
along the canopy rail.  
**THE DECAL MUST BE DRY AND  
SET BEFORE HAND**





# BOTTOM VIEW PLAN

# Royal Australian Air Force 2 OCU Last Classic Hornet 1985 - 2019

- A**  Bright Orange  
FS-22473  
Match to colour  
chip provided
- B**  Matt Linen  
Hum 74
- C**  Light Ghost Grey  
FS-36375
- D**  Medium Grey  
FS-35237
- F**  Steel with a  
Clear Smoke  
over the top
- G**  Polished  
Steel
-  Gloss Black

## NOTE 2

For all other data and panel number placements  
see larger Data and panel number lns sheets

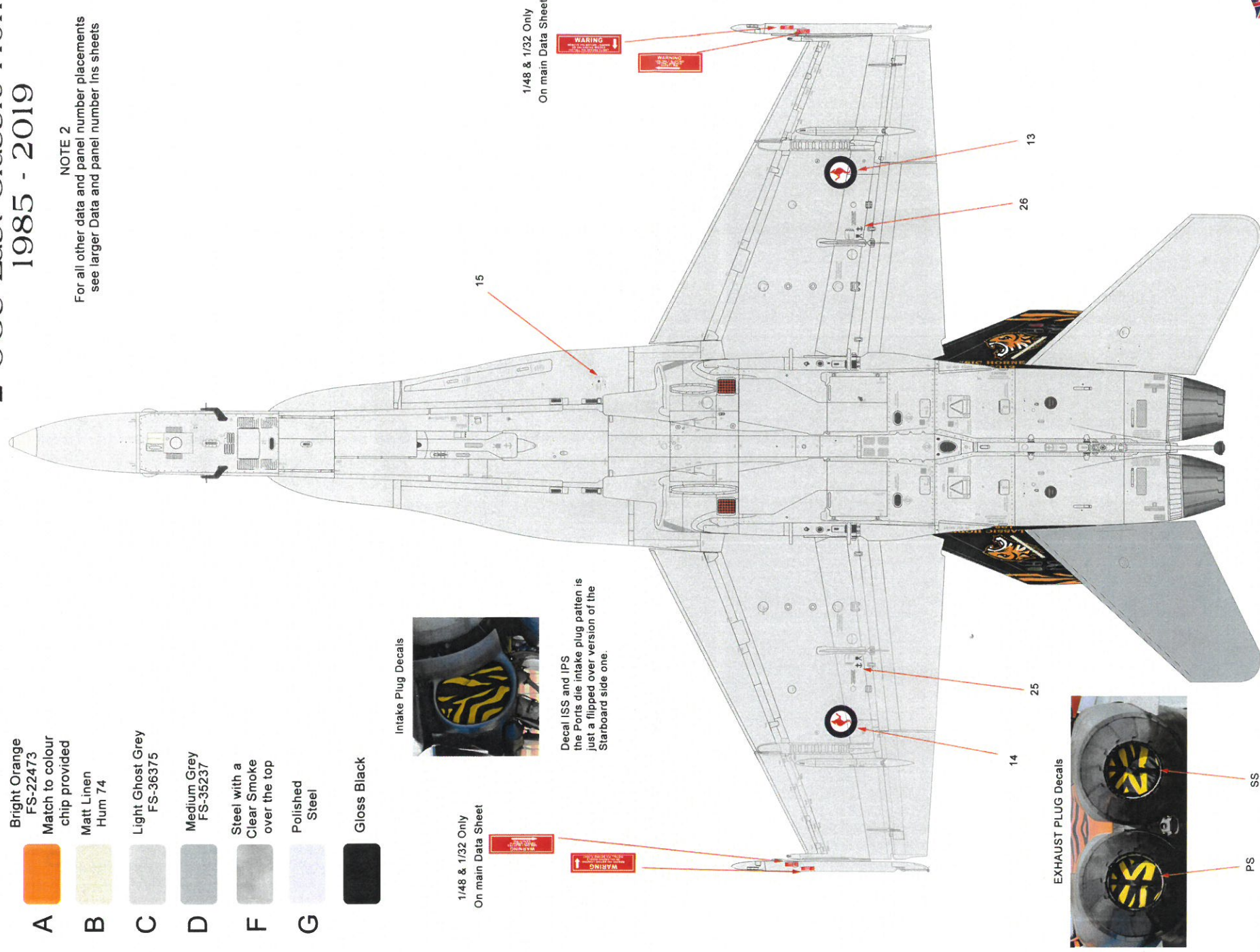

1/48 & 1/32 Only  
On main Data Sheet



Intake Plug Decals

Decal ISS and IPS  
the Ports die intake plug patten is  
just a flipped over version of the  
Starboard side one.

1/48 & 1/32 Only  
On main Data Sheet



EXHAUST PLUG Decals

PS

SS





**Tiger Tank**



Top view



Center Line

Starboard side view



Front

Bottom view



C Line

Front

1. Use the Ruler below to mark up where the stripes have to be positioned on the tank.
2. Mark as shown on the top view drawing.
3. Be sure to make sure it is centred to the middle of the tank.
4. Wet tank down with soapy water to help manoeuvre the decal in to the right place.
5. Place the above decal in the right place and allow it to rap itself around the tank. It should join up at the bottom of the tank in the middle. Some manipulation may be required.



1/72 Tank Ruler



1/48 Tank Ruler

C  Light Ghost Grey  
FS-36375

D  Medium Grey  
FS-35237

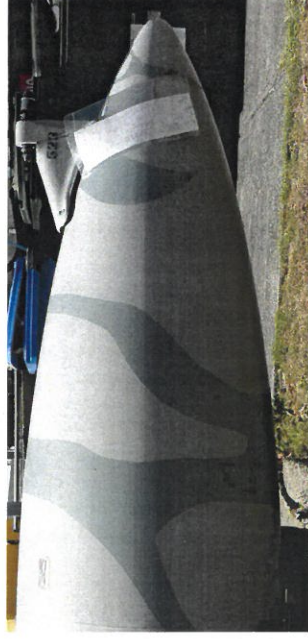
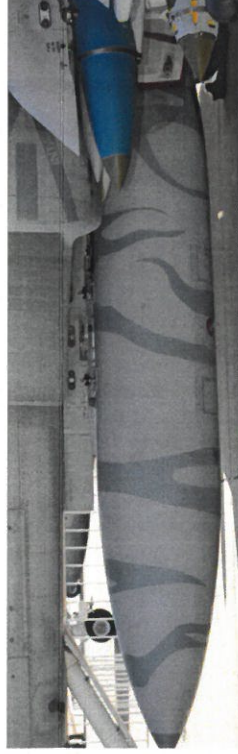

Photo's By RAAF and Ronin Graphics





# RAAF F/A-18 A/B Hornet Weapons pylons & External Fuel Tank Data

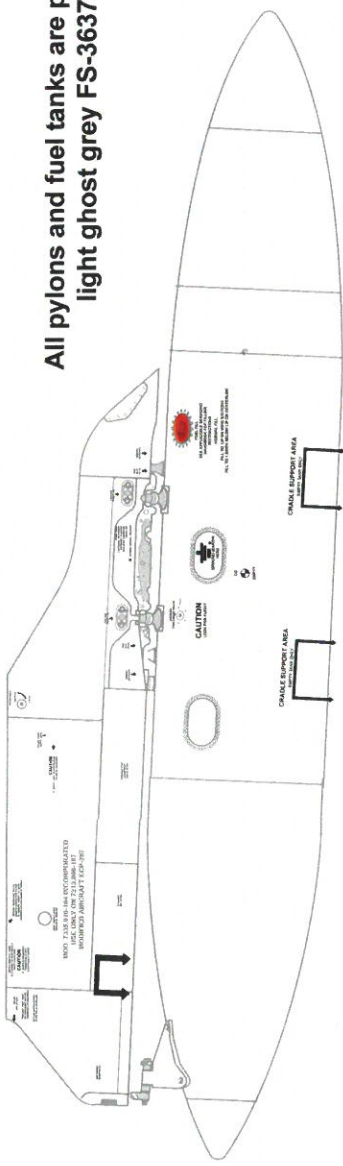
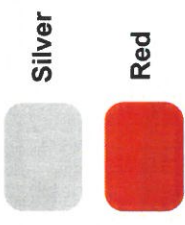
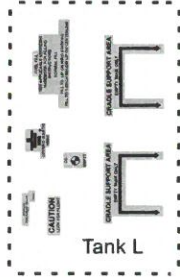

All pylons and fuel tanks are painted light ghost grey FS-36375

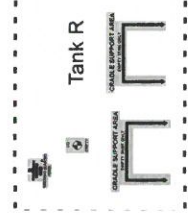

The light grey shading represents the clear decal film. You will note that the data is pre layed out in the in the positions for you.

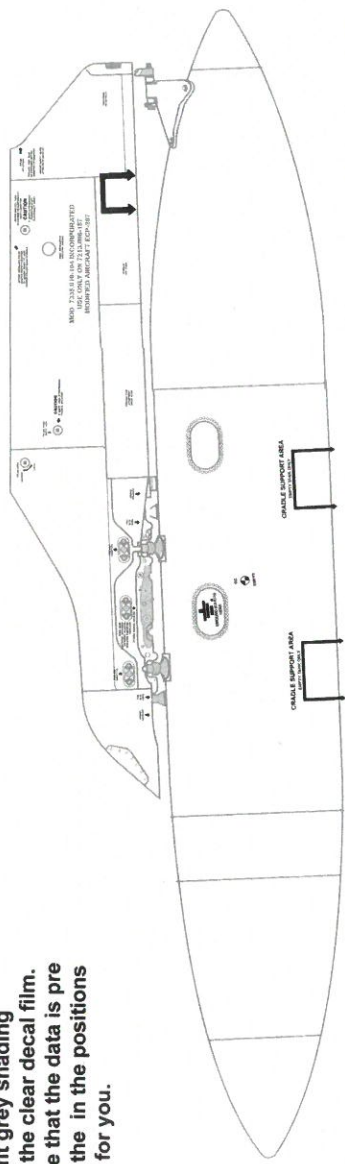

## Ejection seat lables

S4

S1

S5

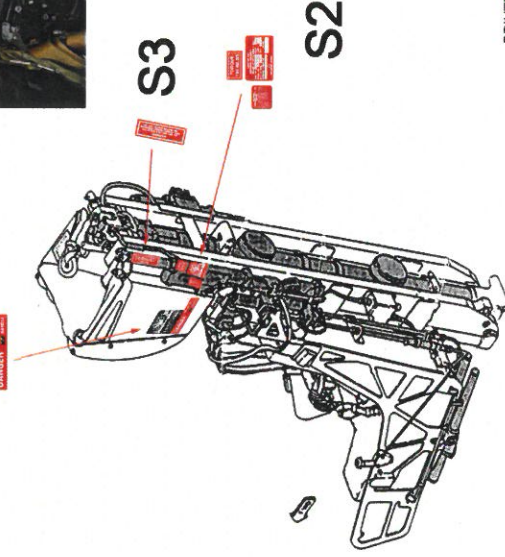
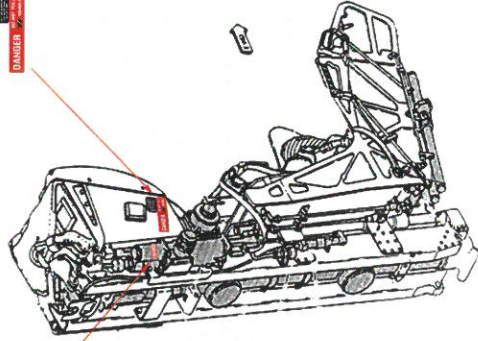







Tiger Tank

THE UNIVERSITY OF  
WESTERN AUSTRALIA  
AUSTRALIAN MADE AND OWNED

Kinetic Tails O Sprue

Kinetic Tails O Sprue

Kinetic Tails O Sprue

RDS-177 20CU F/A-18B Last Classic Tiger Hornet 2019



170



523

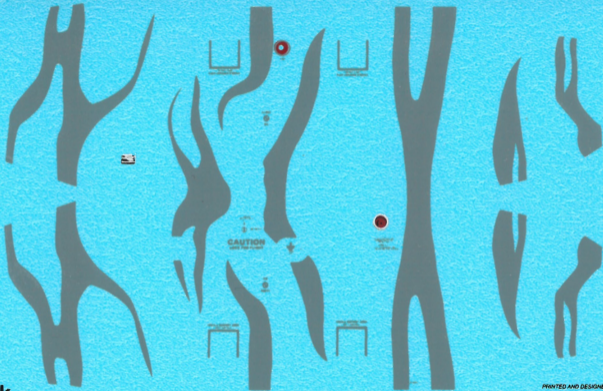

**Tiger Tank**

**RDS-117 20CU F/A-18B Last Classic Tiger Hornet 2019**

PRINTED AND DESIGNED BY  
ROBERT GREGG PAPER AUSTRALIA  
AUSTRALIAN MADE AND OWNED



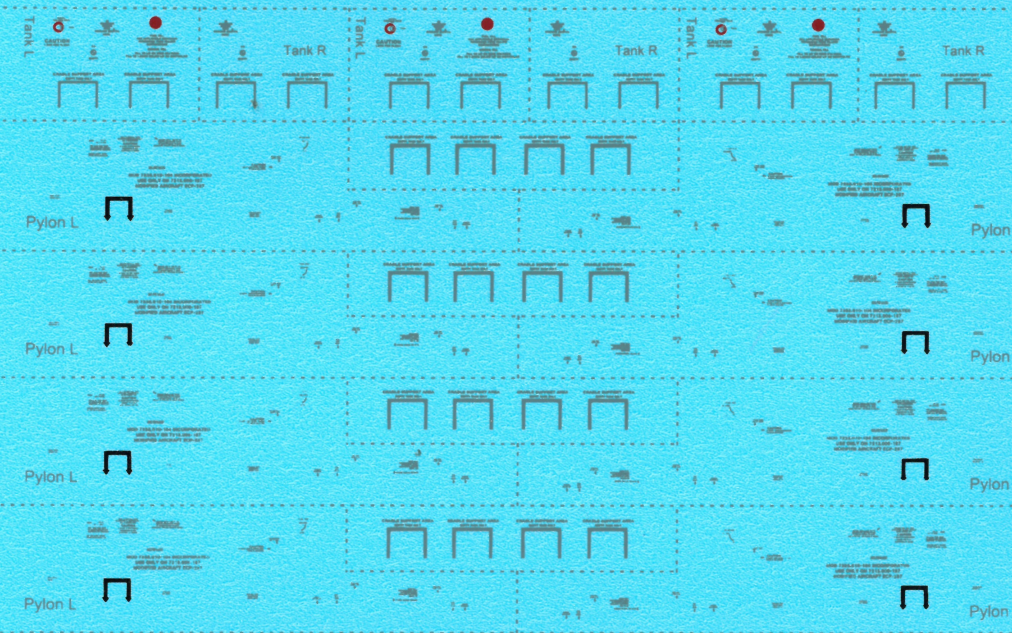
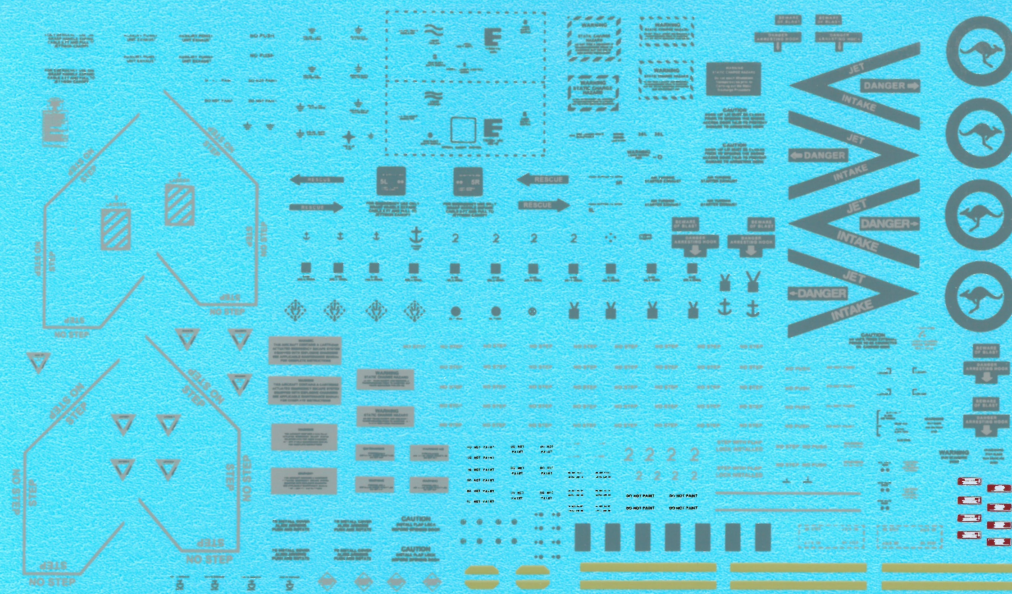

RAAF F/A-18 LEGACY HORNET DATA

PRINTED AND DESIGNED BY:  
 RUPERT GREENIDGE (AUSTRALIAN)  
 AUSTRALIAN MADE AND OWNED





















# RAAF F/A-18 A/B Hornet Panel Number Placement.

## Bottom View

Panel numbers between  
intake lip and fuse barrel

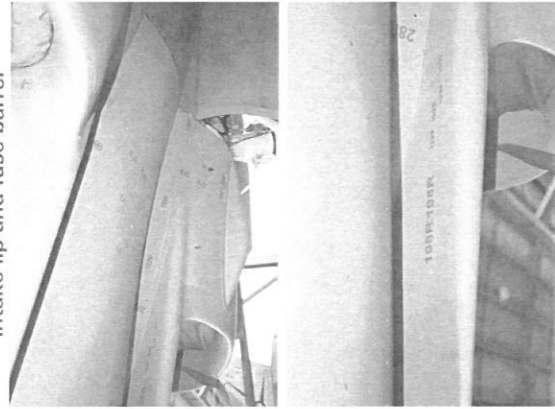

Note:

Some aircraft have panel numbers  
in slightly different positions on the panels.  
As it depends on the aircraft painter.

Panel numbers between  
intake lip and fuse barrel



Note:  
Positioning of panel numbers on decal sheet

34 35

34L 34R 35L 35R  
34L 34R 35R 35R

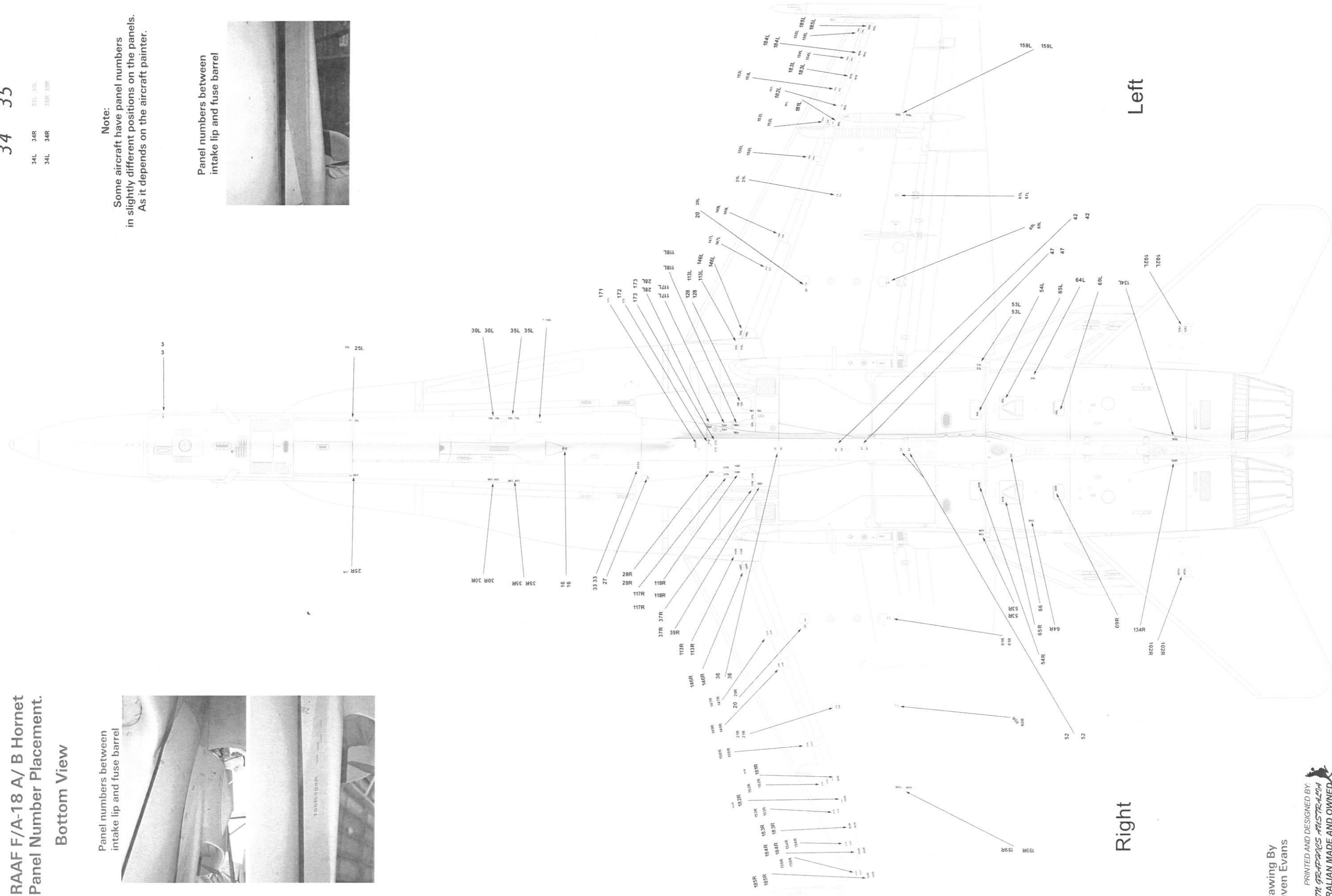

Right

Left

Drawing By  
Steven Evans

PRINTED AND DESIGNED BY  
RONIN GRAPHICS AUSTRALIA  
AUSTRALIAN MADE AND OWNED