

USS ORISKANY CV-34 (1960S)

1/700 SCALE

JFL 001

JIM SHIRLEY PRODUCTIONS RESIN MODELS 1/700 SCALE "FLEET LINE" SERIES

PARTS LIST

- | | |
|---------------------------------|--------------------------|
| 1) LOWER HULL | 23) LARGE RADAR |
| 2) FLIGHT DECK | 24) ISLAND REAR WALK |
| 3) UPPER SUPERSTRUCTURE | 25) ISLAND WALKWAY PORT |
| 4) LOWER SUPERSTRUCTURE | 26) HOSE REELS |
| 5) DECK SUPPORT STRUCTURE, REAR | 27) ROUND RADAR ARM |
| 6) DECK SUPPORT SPANSON, FWD | 29) RESIN MAST |
| 7) STR FWD HULL DECK | 29) HULL BULKHEADS A-1 |
| 8) REAR PORT HULL DECK | 30) ANTIKNA SUPPORTS |
| 9) FWD PORT HULL DECK | 31) TOW CARTS |
| 10) TANTAIL | 32) LIFE RAFT BASKETS |
| 11) SMALL MAST TOP RADAR | 33) FWD ELEVATOR |
| 12) LARGE RADAR BASE | 34) REAR ELEVATOR |
| 13) MAST TOP | 35) ISLAND RADAR SUPPORT |
| 14) ROUND RADAR BASE | 36) RADOME |
| 15) SMALL RADAR | 37) CRANE |
| 16) ECM ANTENNAE (4) | 38) DECK TRUCK |
| 17) SMALL BOAT | 39) FC RADAR DISH |
| 18) RADOME BASE | 40) FC RADAR BASE |
| 19) FIVE INCH GUNS (5) | 41) ROUND RADAR |
| 20) GUN BASES (5) | 42) ECM PITS |
| 21) FLAG BASE (3) | 43) SMALL MAST RADAR |
| 22) ISLAND WALKWAY | |

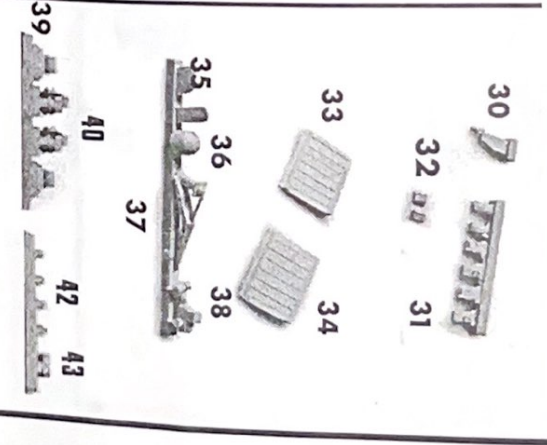
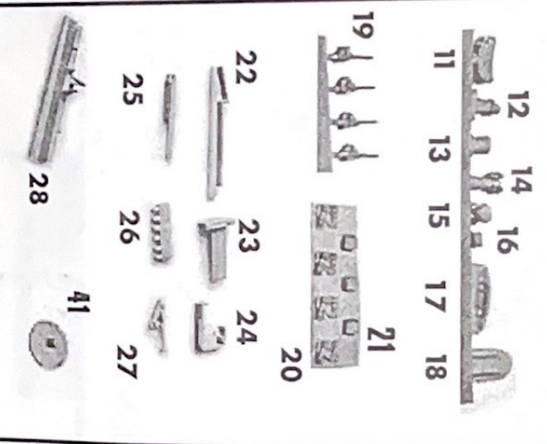
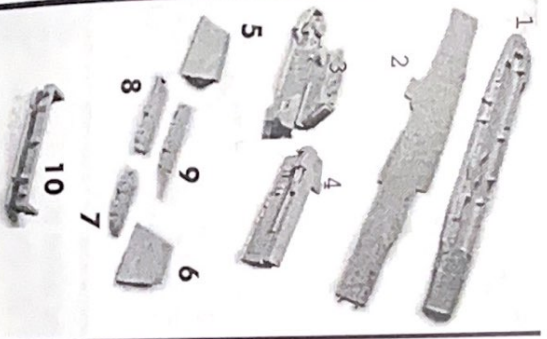

PROTOTYPED PART

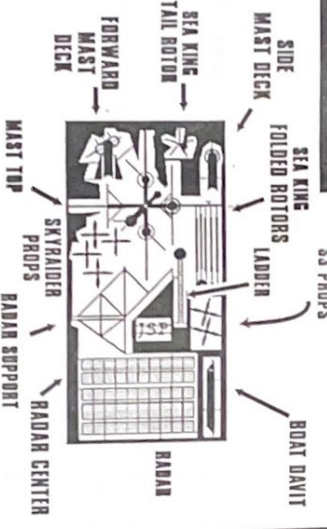

ISLAND SUPERSTRUCTURE ASSEMBLY

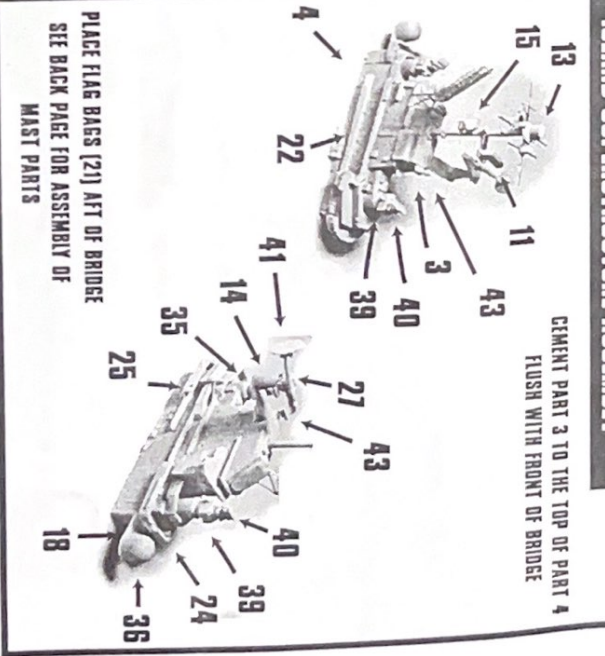

THIS MODEL IS MADE FROM CAST RESIN, PLYWOOD, AND PROTOTYPED BRASS PARTS. SOME MINOR CLEANUP OF PARTS IS TO BE EXPECTED. REMAINING FLASH, LEFT TO PROTECT DELICATE PARTS, IS EASILY CLEANED UP WITH AN X-ACTO KNIFE. CAREFUL DRY-FITTING OF PARTS IS RECOMMENDED. □

BENT PARTS CAN BE RESHAPED BY IMMERSING THEM IN HOT WATER FOR A FEW SECONDS AND BENDING INTO SHAPE. LONGER PARTS CAN BE RESHAPED WITH A HAIR DRYER.

USE CYANOACRYLATE GUE (SUPER GUE) TO CEMENT PARTS. USE GUE SPARINGLY! SOME PARTS MAY NEED FLAT SANDING TO REMOVE RESIN OVERSPURS, AND MOST OF ALL, HAVE FUN!

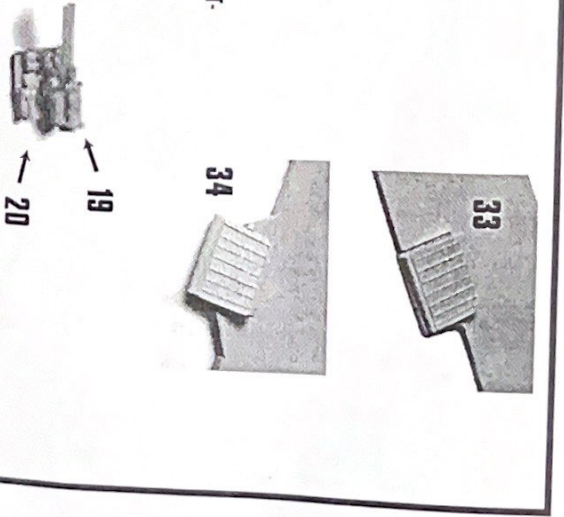
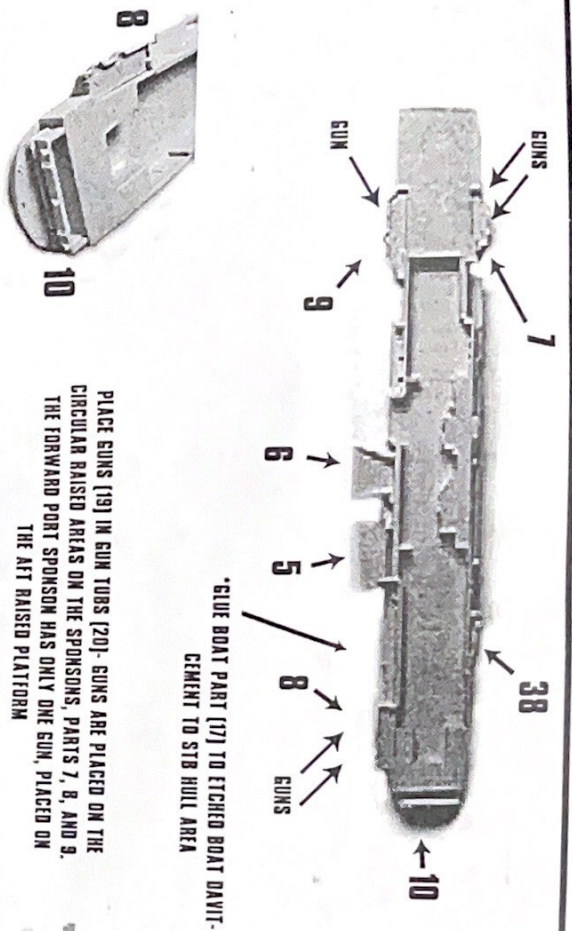
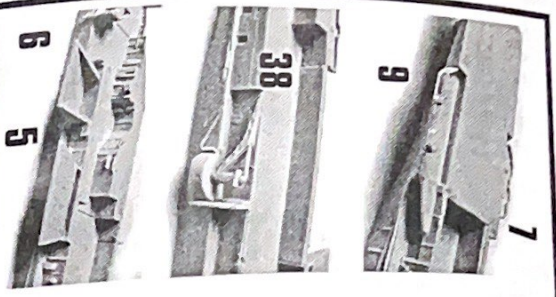

PART #30 ANTENNA MOUNTS

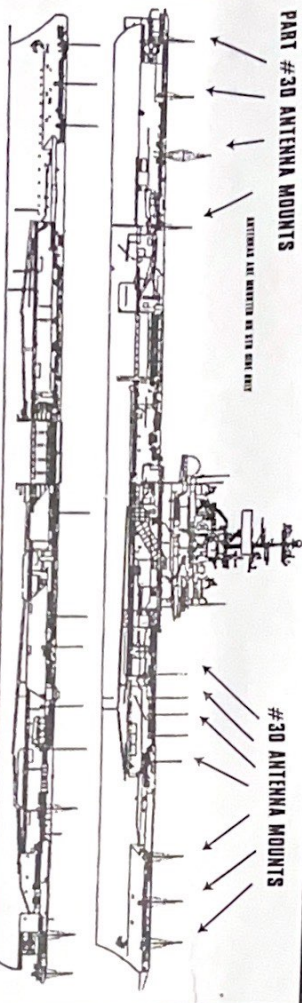

PARTS #32 LIFE RAFT BASKETS

PLACE ON EITHER SIDE OF HULL PER DRAWINGS

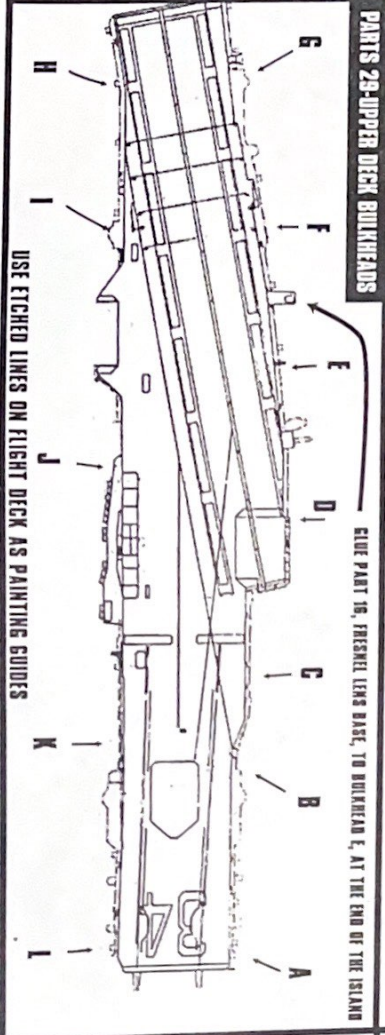

MAST ASSEMBLY

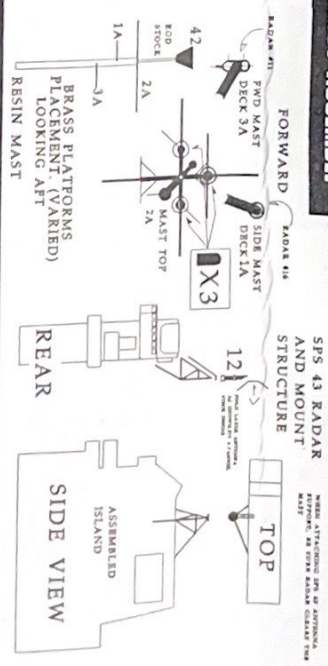

© COPYRIGHT 1997 JIM SHIRLEY PRODUCTIONS
P.O. BOX 951108 LAKE MARY, FLORIDA 32795-1108

USS ORISKANY PAINTING GUIDE

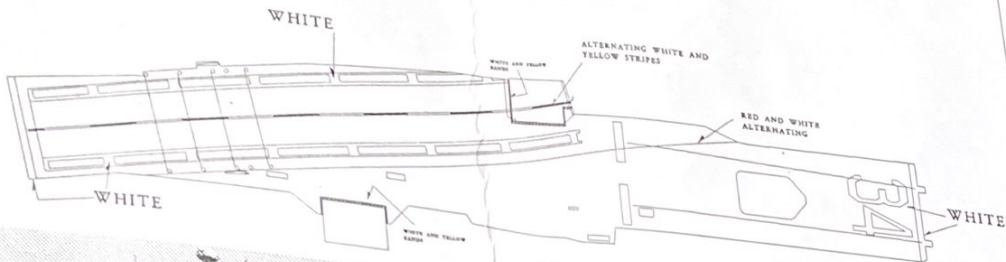

BASE DECK COLOR IS DARK GRAY WITH HEAVY WEATHERING.
 HULL AND ALL VERTICAL STRUCTURES ARE PAINTED HAZE GRAY.
 LIFE RAFT PODS ARE BLACK.
 ALL ANTENNAS AND SUPPORTS ARE BLACK.

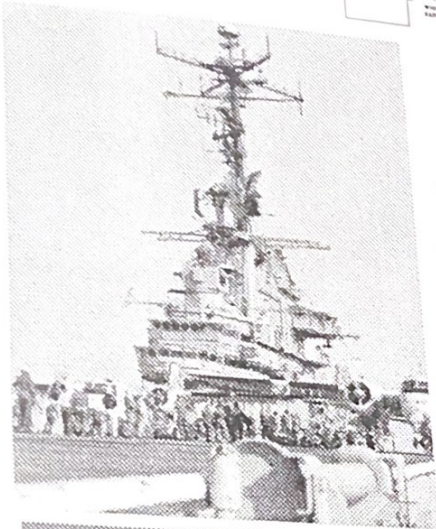

JIM SHIRLEY PRODUCTIONS
 1/700 SCALE "FLEET LINE" SERIES

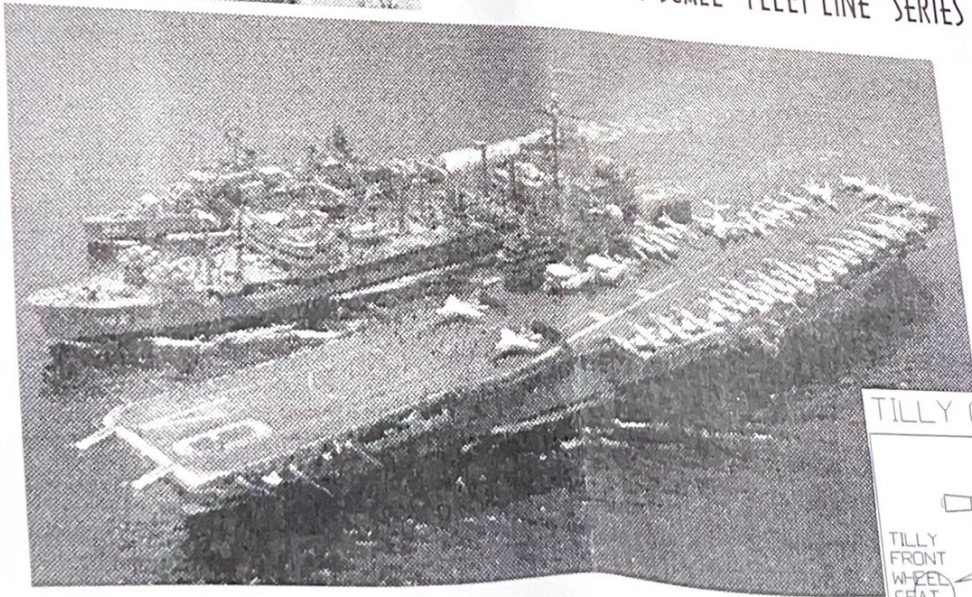

TILLY CRANE ASSEMBLY

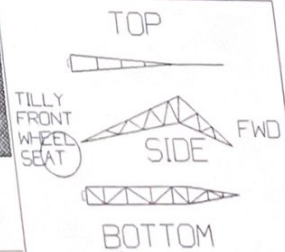

USE SPRUE FOR FABRICATION