

eduard
MASK

F4U-1D Corsair 1/48

The die-cut mask for accurate canopy frame painting of the
Tamiya 1/48 KIT

EX 033

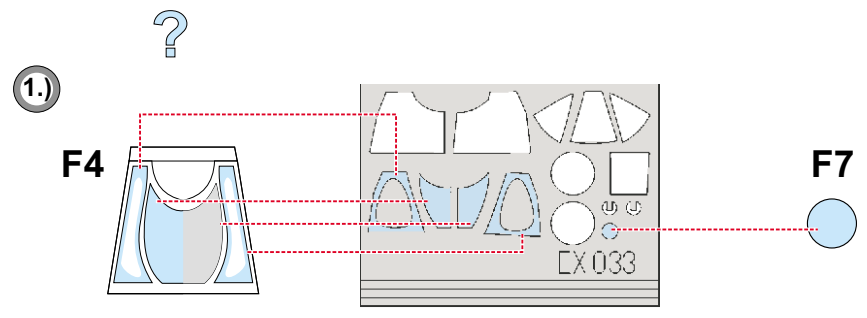
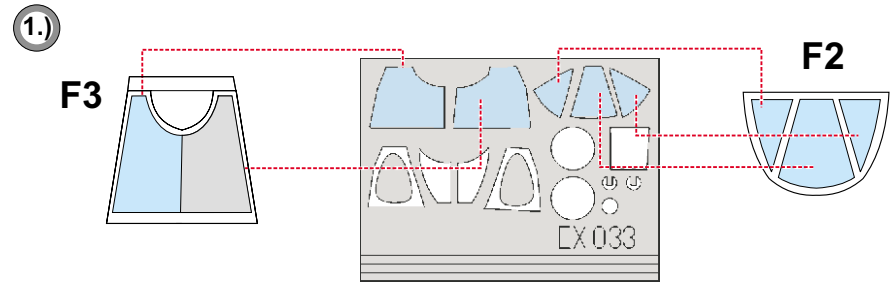
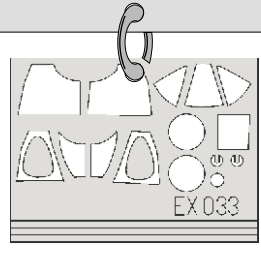

② INTERIOR COLOR

③ CAMOUFLAGE COLOR

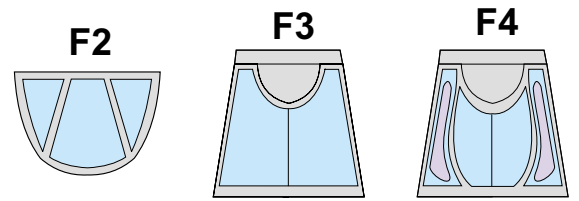
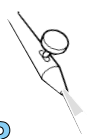

- LIQUID MASK

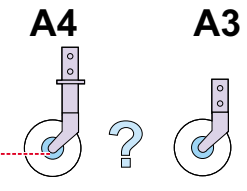
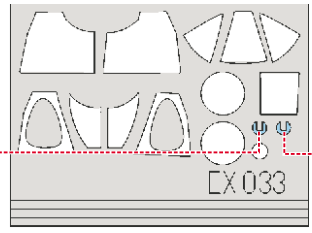
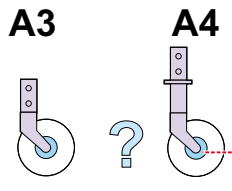
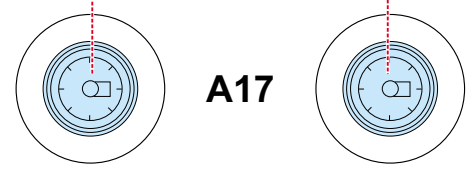
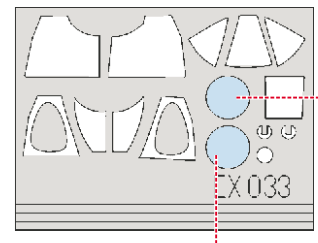
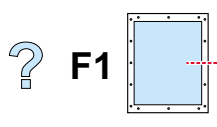
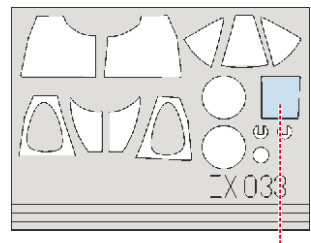

- LIQUID MASK

- LIQUID MASK