

ADV 40MM BOFORS-GMC

(2) TUBE DE RECHANGE
SPARE BARREL

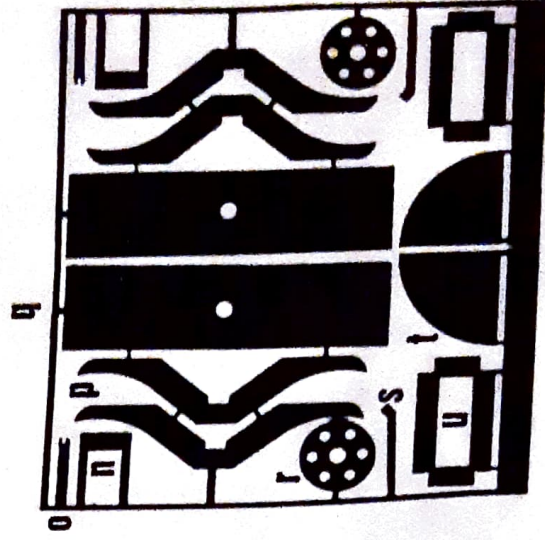

PHOTOCOPIE / BRASS SET

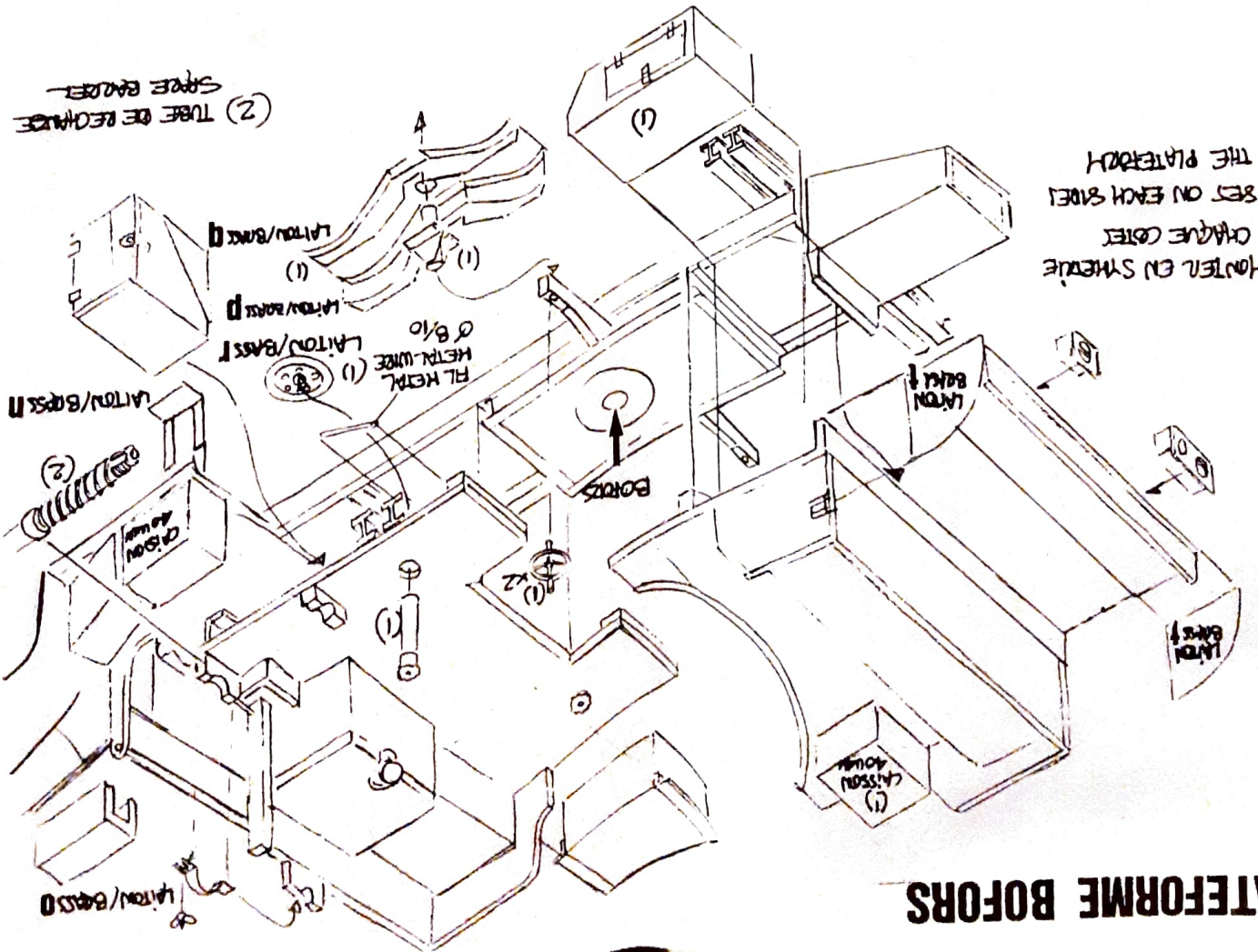
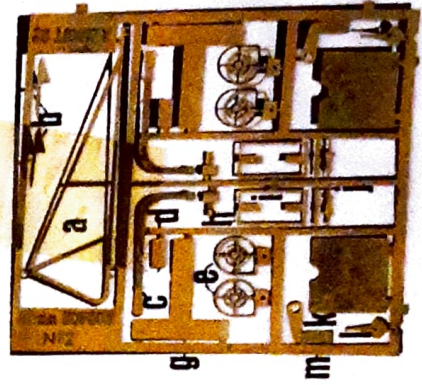

PLATEFORME BOFORS

BERGÉAU

PLATEFORME DE TIR

NB = MONTÉL D'ARMS MACHÉPIÉD + GROVE TUSQUARE DUS FIVE
 HONRGE AVTES PIECES
 SET FIRST FOOTPIECE + TUNAPR FRAME, THEN COMPLETE
 SETUPS OF OTHER PARTS

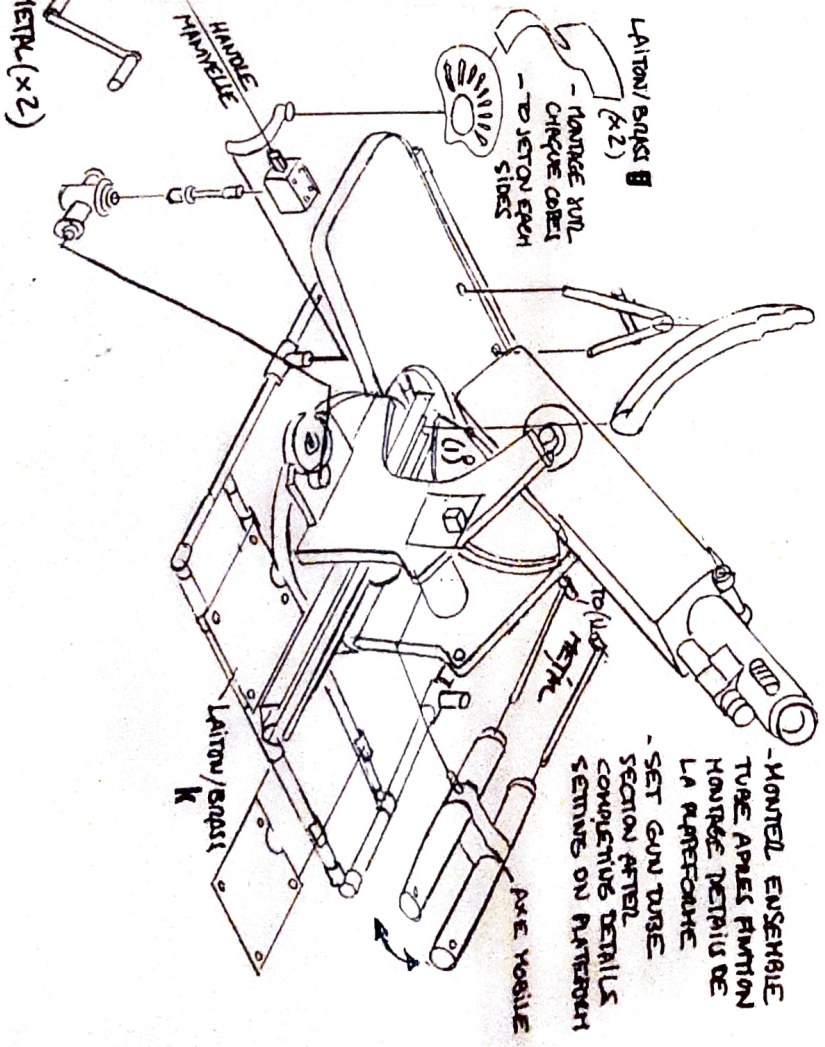
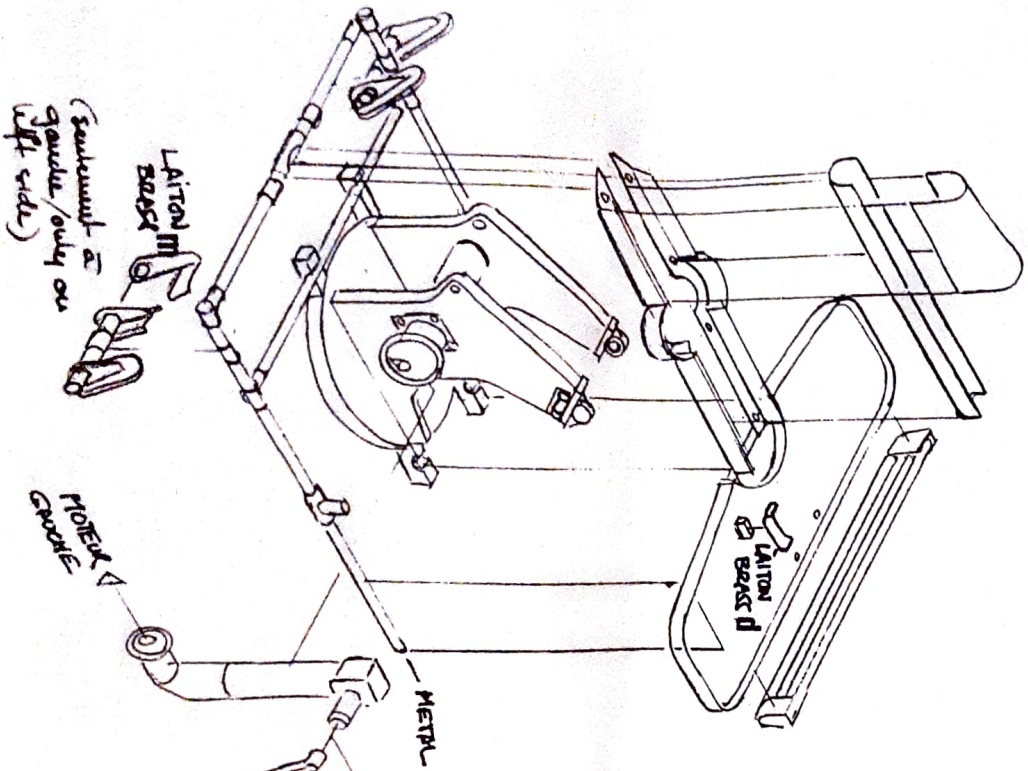

CHASSIS

VUE LATÉRALE GAUCHE

VUE DE DESSUS

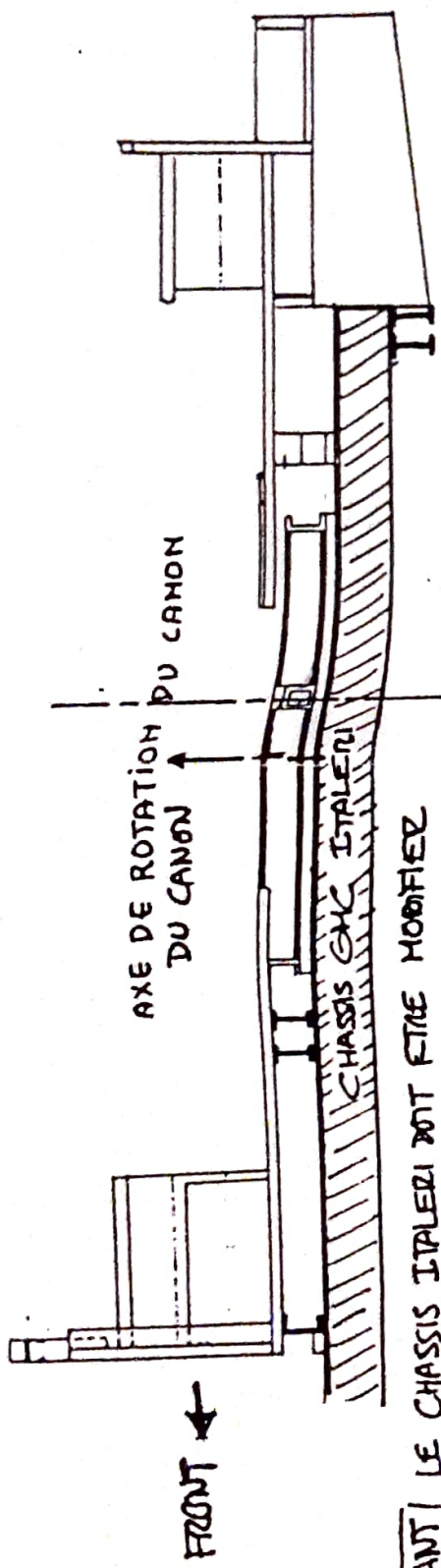

IMPORTANT LE CHASSIS ITALERI DOIT ÊTRE MODIFIÉ EN ENLEVANT LES LONGERONS PLACÉS À L'ARRIÈRE DU CHASSIS. MODIFY ITALERI CHASSIS BY REMOVING BEAMS FROM REAR FRAME SECTION.

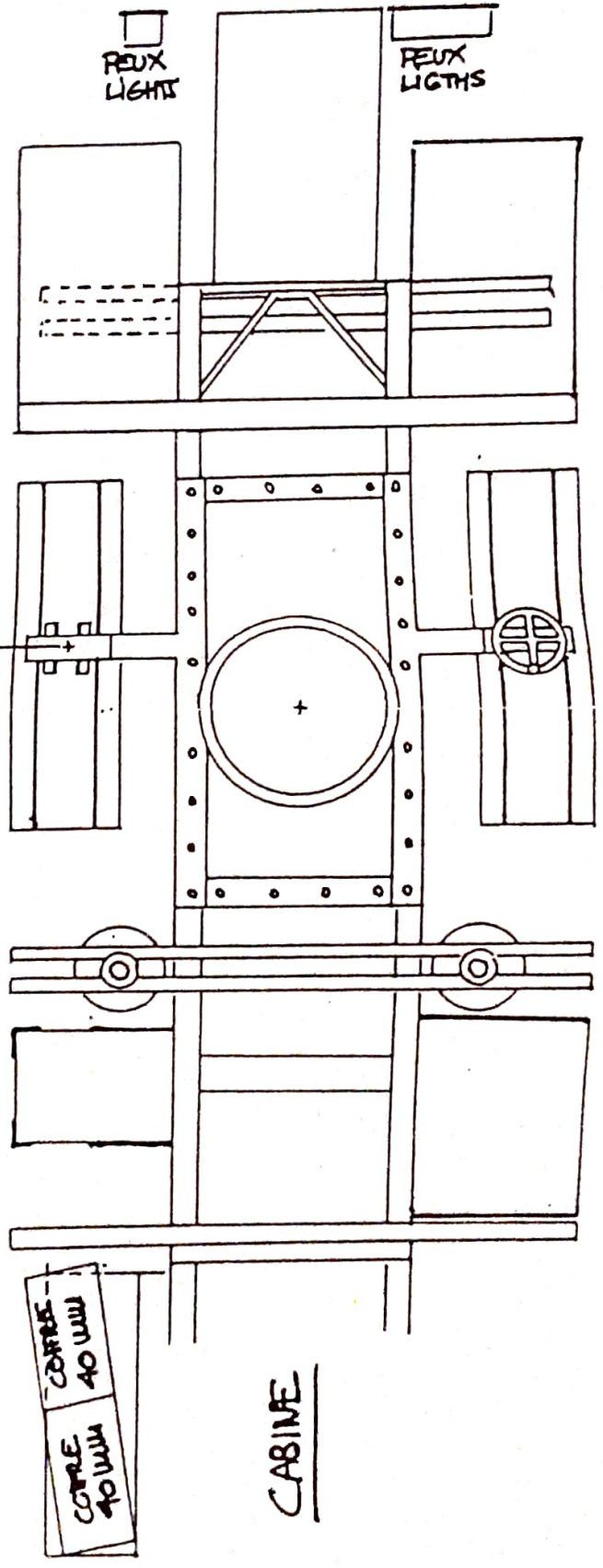

CABINE

TUBE

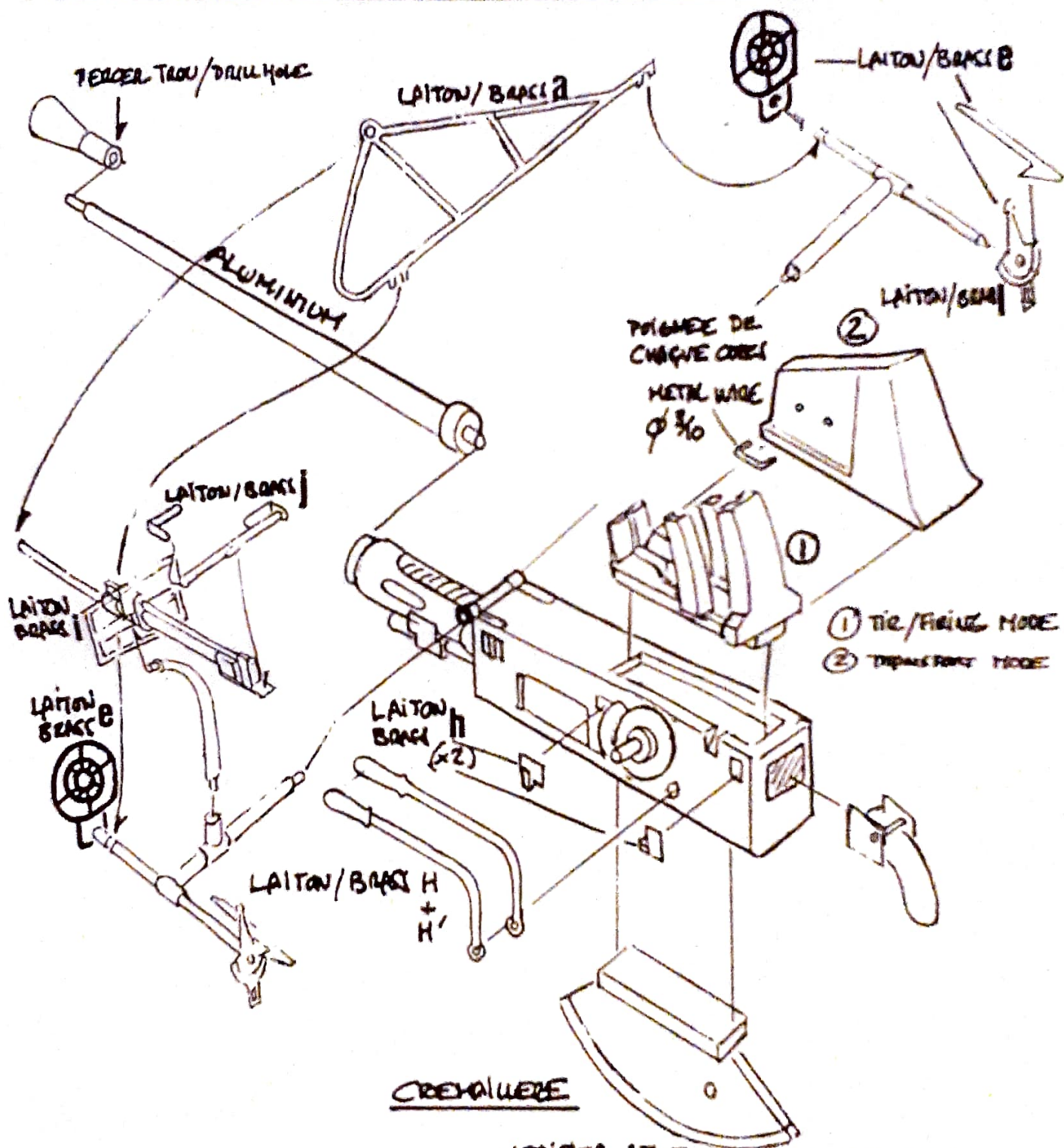

VERIFIER AJUSTEMENT SUR BERCEAU
CHECK SETTING ON CRADLE