

Model Alliance Decals - UK & The Aviation Workshop are trading names of The Aviation Workshop Publications Ltd & Gary Madgwick. The On-Target Publications, AIRframe Journal, Spot-Lights & Conflict /AirWars are all names registered to The Aviation Workshop Publications Ltd and may not be used without the permission in writing of the The Aviation Workshop Publications Ltd. These decals and all artwork are copyright The Aviation Workshop Publications Ltd 2009



Decals Instructions:

These decals are a high quality product produced for Model Alliance Decals - UK by Cartograf Italy. The decals are very thin but very strong and flexible.

- 1. Before painting the model, clean with 'Model Wipes'. This cleans the grease and any dust from the surface.**
- 2. We recommend that you wear 'Model Gloves' to handle the model whilst preparing it for painting.**
- 3. For best results, spray the model with a Light Grey primer, any defects can then be made good.**
- 4. For demarcation and camouflage lines, we recommend that you use Masking Film.**
- 5. If you wish to use a decal fixing and finishing system, we recommend you use the Microscale System, do not use strong decals solvents such as Solvaset.**
- 6. Once you are happy with the painting of the model, coat it in a clear gloss finish, this can either be over the entire model if the model is finished glossy or spot gloss finish in the area's that have a decal. A good surface finish are clear floor shine's such as Johnson wax - Klear. This is sold under different names around the world. Klear can be either brushed on or sprayed.**
- 7. Cut each decal from the sheet as needed. Do not trim the clear varnish finish to close to the decal. Submerge the decal in warm water for about 10 seconds and remove to a flat surface and wait for the decal to release from the backing sheet. A small amount of washing up liquid in the warm water helps the decal release from the sheet.**
- 8. These decals do not require a decal setting solution to lay flat or to conform to the model contours.**
- 9. With a pair of tweezers to hold the backing sheet, slide the decal in position on the model using a small soft brush. Do not use an old painting brush as bits can get under the decal.**
- 10. Carefully remove any excess water with a soft cloth or tissue once you are happy with the position of the decal. Should you make a mistake, dip a brush in the warm water and ease under the edge of the decal. The decal will then easily move to the correct position and again remove the excess water.**
- 11. When the decals are completely dry, gently wipe off all excess decal adhesive.**
- 12. Leave the model to dry completely, spray or paint over the decals with a further coat of Klear or gloss.**
- 13. Should the decal silver for any reason, this is because small air bubbles are under the decal. If found, prick with a pin and apply a small drop of Micro Sol to the decal and allow to dry for up to 12 hours.**
- 14. Finally, coat the model with the required finish, either gloss, semi gloss or matt.**
- 15. Decals are best stored flat and in a cool, dry place and should not be stored in direct sunlight, hot or humid conditions.**
- 16. Should you have any problems with these decals please contact us at the address below.**



The Aviation Workshop

Watermill Studio, Unit 13/14A, Home Farm,
Ardington, Wantage, Oxon, OX12 8EP, UK
www.theaviationworkshop.co.uk

Email: info@theaviationworkshop.co.uk



General Dynamics F-16C (Block 40) 115 (formerly 90-0035) of 1 Squadron, based at Sheikh Isa AB, Bahrain, in 2008.

Recommended F-16C Kits:

- | | | | |
|------------|-----------|-------------|----------|
| 1/72 Scale | Hasegawa | 1/48 Scale: | Academy |
| | Hobbyboss | | Tamiya |
| | Academy | | Hasegawa |
| | Revell | | |
| | Italeri | | |
| | Fujimi | | |

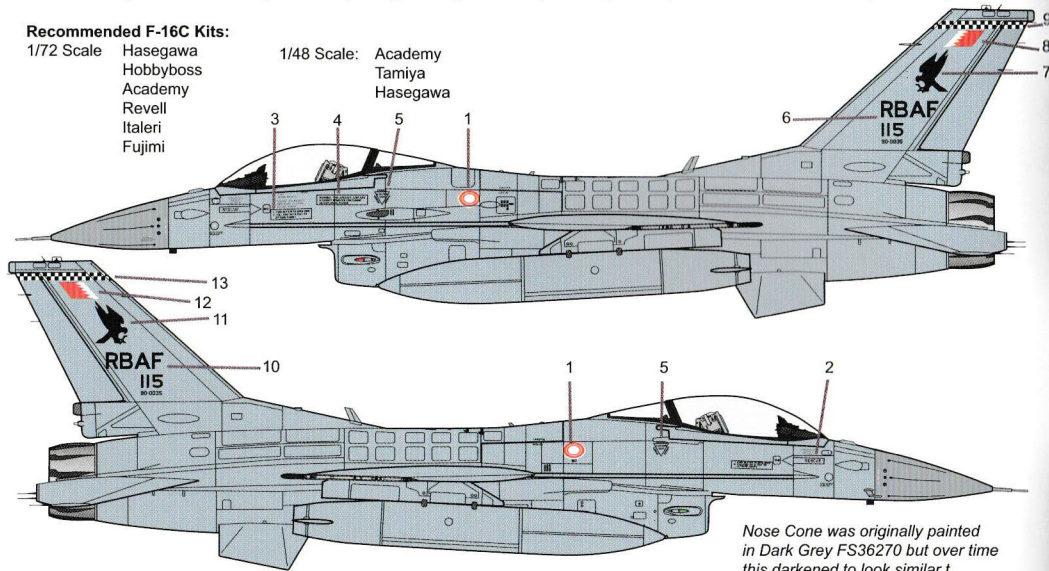

Nose Cone was originally painted in Dark Grey FS36270 but over time this darkened to look similar to FS36132

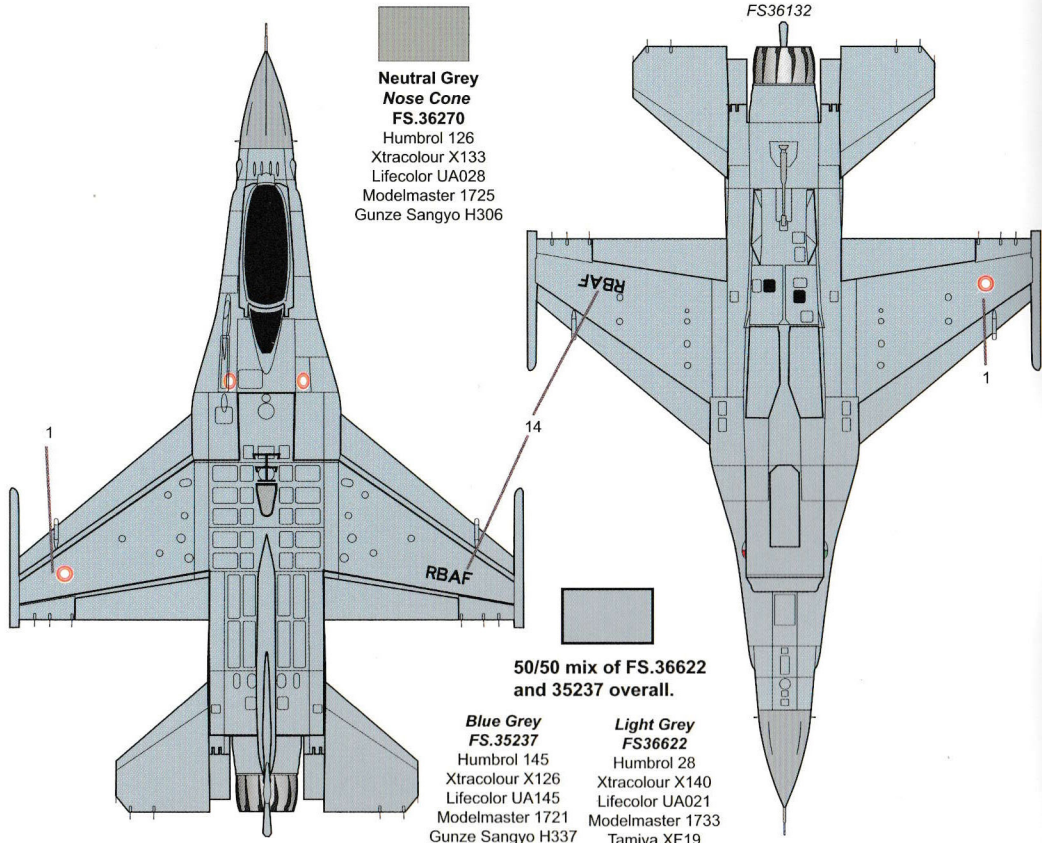

**Neutral Grey
Nose Cone
FS.36270**
Humbrol 126
Xtracolour X133
Lifecolor UA028
Modelmaster 1725
Gunze Sangyo H306

**50/50 mix of FS.36622
and 35237 overall.**

- | | |
|---|---|
| Blue Grey
FS.35237
Humbrol 145
Xtracolour X126
Lifecolor UA145
Modelmaster 1721
Gunze Sangyo H337 | Light Grey
FS36622
Humbrol 28
Xtracolour X140
Lifecolor UA021
Modelmaster 1733
Tamiya XF19
Gunze Sangyo H311 |
|---|---|

Lockheed Martin F-16C (Block 40) 207 of 2 Squadron, based at Sheikh Isa AB, Bahrain, in 2008.

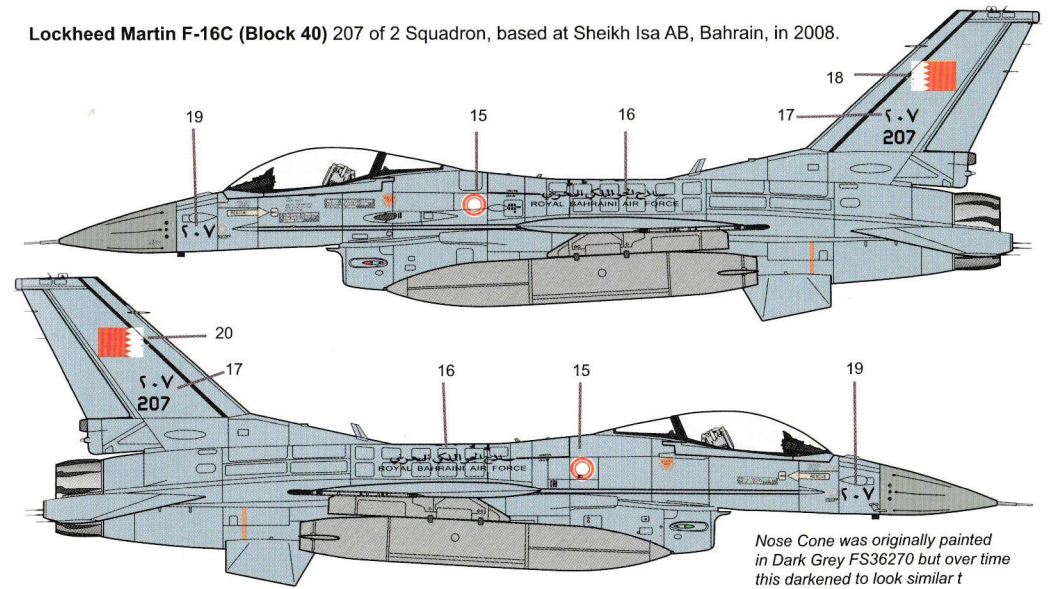

Nose Cone was originally painted in Dark Grey FS36270 but over time this darkened to look similar to FS36132

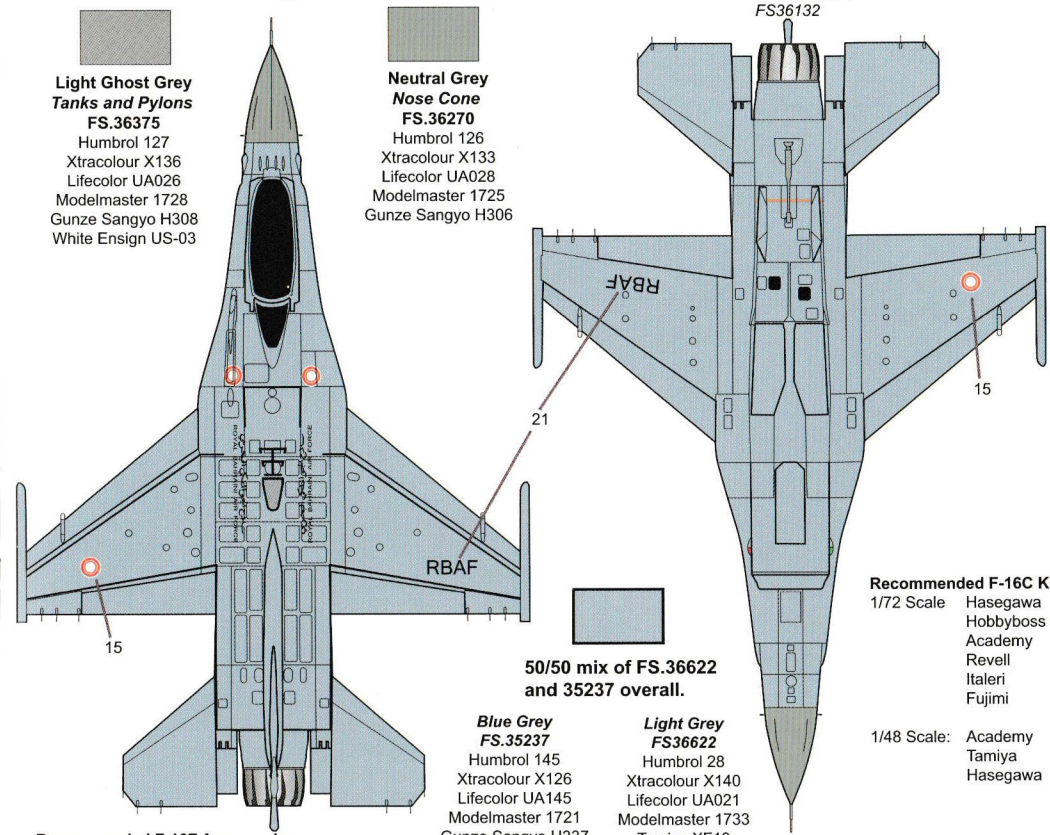

**Light Ghost Grey
Tanks and Pylons
FS.36375**
Humbrol 127
Xtracolour X136
Lifecolor UA026
Modelmaster 1728
Gunze Sangyo H308
White Ensign US-03

**Neutral Grey
Nose Cone
FS.36270**
Humbrol 126
Xtracolour X133
Lifecolor UA028
Modelmaster 1725
Gunze Sangyo H306

**50/50 mix of FS.36622
and 35237 overall.**

- | | |
|---|---|
| Blue Grey
FS.35237
Humbrol 145
Xtracolour X126
Lifecolor UA145
Modelmaster 1721
Gunze Sangyo H337 | Light Grey
FS36622
Humbrol 28
Xtracolour X140
Lifecolor UA021
Modelmaster 1733
Tamiya XF19
Gunze Sangyo H311 |
|---|---|

Recommended F-16F Accessories:
1/72 Scale: AIRFrame CS-125 600n Gallon Fuel Tanks
AIRFrame CS-144 Litening III Pods

Recommended F-16C Kits:

- | | |
|-------------|-----------|
| 1/72 Scale | Hasegawa |
| | Hobbyboss |
| | Academy |
| | Revell |
| | Italeri |
| | Fujimi |
| 1/48 Scale: | Academy |
| | Tamiya |
| | Hasegawa |

Panavia Tornado IDS MLU MM7006 of 6 Stormo, 154 Gruppo, based at Brescia-Ghedi AB, Italy, in 2007. This machine was specially decorated to celebrate 25 years on the Tornado with 154 Gruppo.

Bolt-on in-flight re-fuelling probe fitted over the ejection seat and anniversary markings.

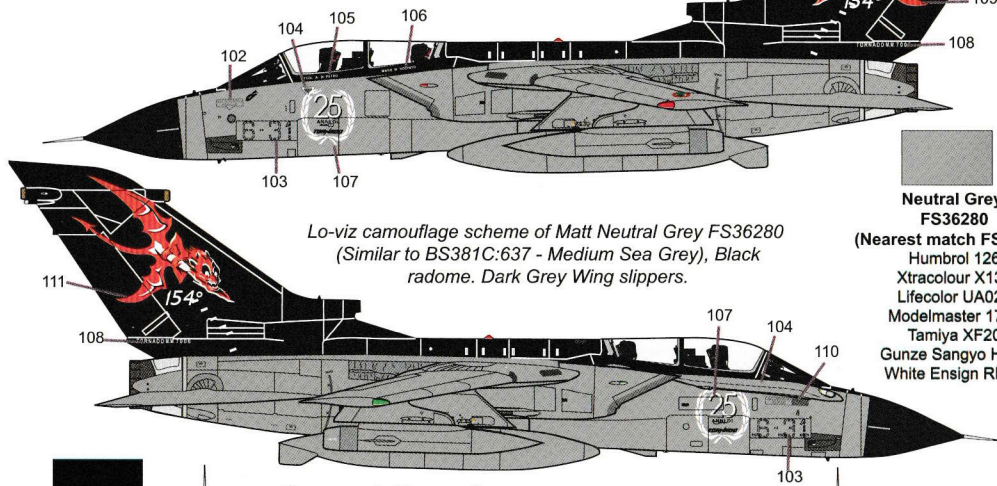

Neutral Grey FS36280
(Nearest match FS36270)
Humbrol 126
Xtracolor X133
Lifecolor UA028
Modelmaster 1725
Tamiya XF20
Gunze Sangyo H306
White Ensign RN04

Lo-viz camouflage scheme of Matt Neutral Grey FS36280 (Similar to BS381C:637 - Medium Sea Grey), Black radome. Dark Grey Wing slippers.

Black
Xtracolor X404
Humbrol 33
Lifecolor LC02
Model Master 1749

Recommended Accessories:
1/72 Scale: AIRFrame CS-114 Tornado update (This includes the smaller fuel tanks)
AIRFrame CS-116 Paveway II Bombs
AIRFrame CS-143 Sniper designating Pod
AIRFrame CS-144 Litening III Pod
AIRES Cockpit set
Airwaves Wing set with dropped flaps

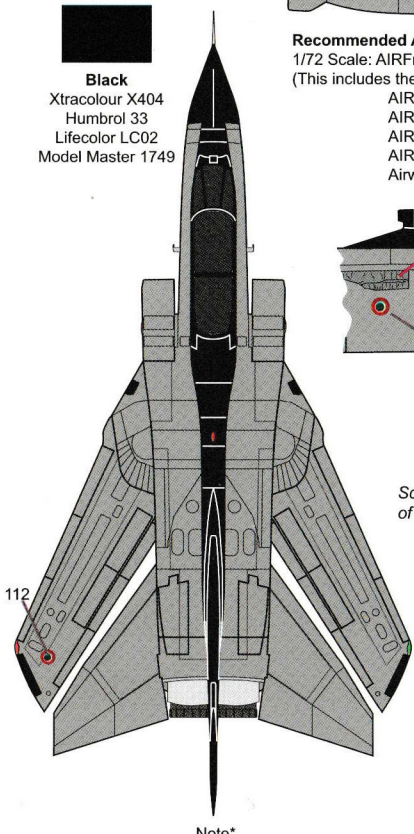

Dark Grey
Scrap view shows the position of the fuselage roundel, which is normally obscured by the wing pylons.

Scrap view shows the demarcation of the wing root glove.

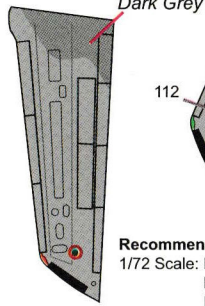

Recommended Kits:
1/72 Scale: Revell Tornado ECR
Hasegawa Tornado IDS
Italeri Tornado ECR

1/48 Scale: Hobbyboss Tornado IDS
Italeri Tornado IDS

Note*

We recommend that you use the superb Tauro Decals Italian Air Force, Tornado Stencil set.

Grumman E-2C "Hawkeye" 165456 / 2 of Flottille 4.F, based at NAB Lann-Bihoué, France, in 2009. Seen at RNAS Yeovilton Air Day in 2009.

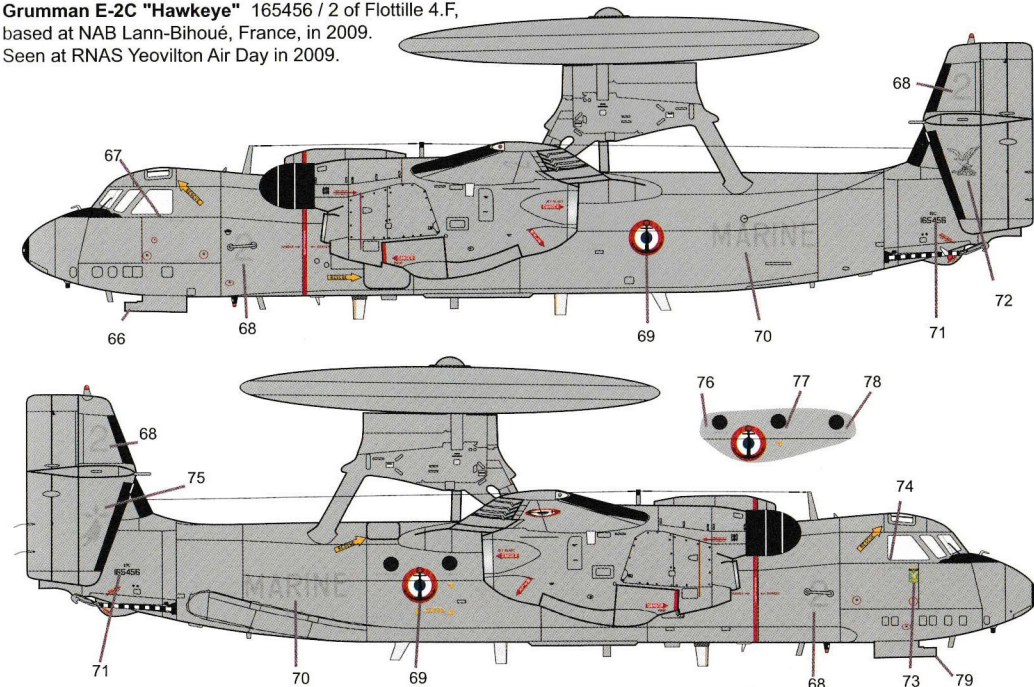

Recommended Kits:
1/72 Scale: Hasegawa
1/48 Scale: Kinetic

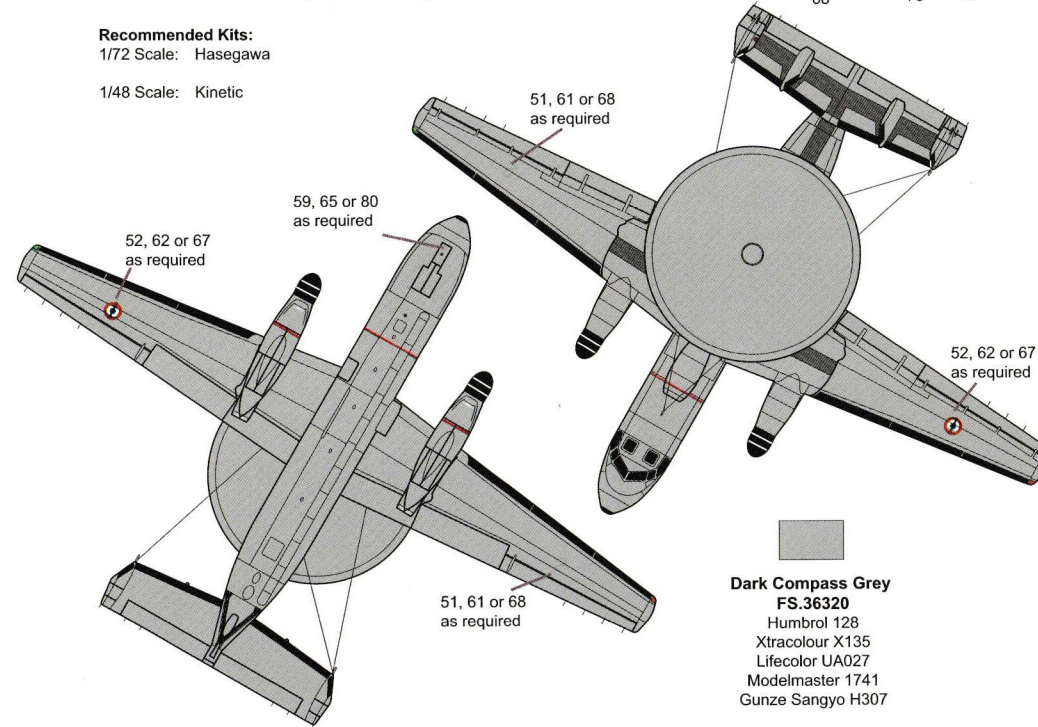

Dark Compass Grey FS.36320
Humbrol 128
Xtracolor X135
Lifecolor UA027
Modelmaster 1741
Gunze Sangyo H307

The numerals are applied in the same positions as above for both 165455 and 165417, including the nose-wheel door. The cockades and numerals on both the upper and undersurfaces are toed outboard to 3 degrees.

Grumman E-2C "Hawkeye" 165455 / 1 of Flottille 4.F,
based at NAB Lann-Bihoué, France, in 2008.

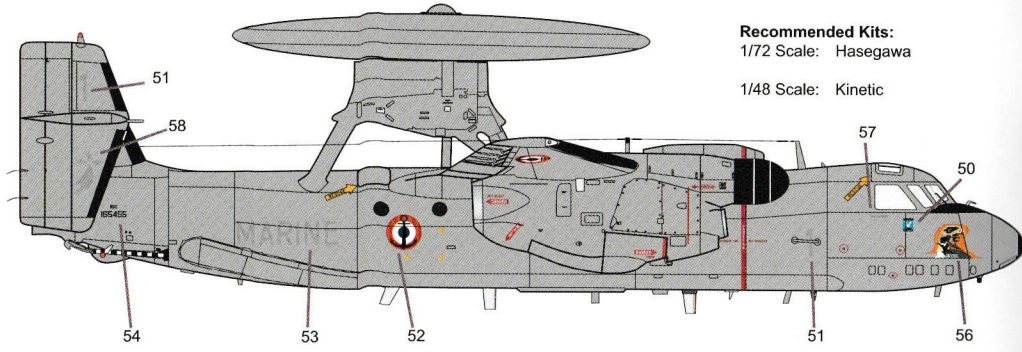
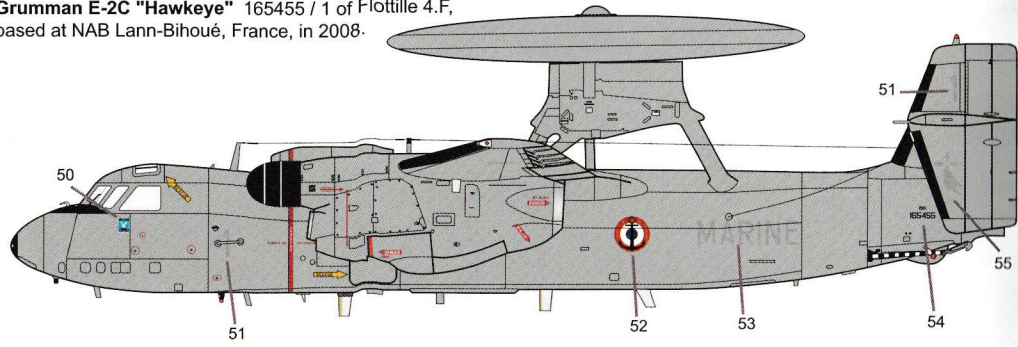

Recommended Kits:
1/72 Scale: Hasegawa
1/48 Scale: Kinetic

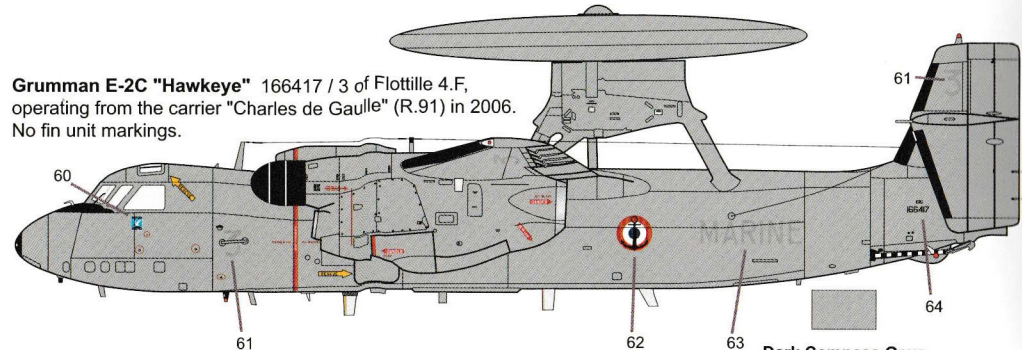

Grumman E-2C "Hawkeye" 166417 / 3 of Flottille 4.F,
operating from the carrier "Charles de Gaulle" (R.91) in 2006.
No fin unit markings.

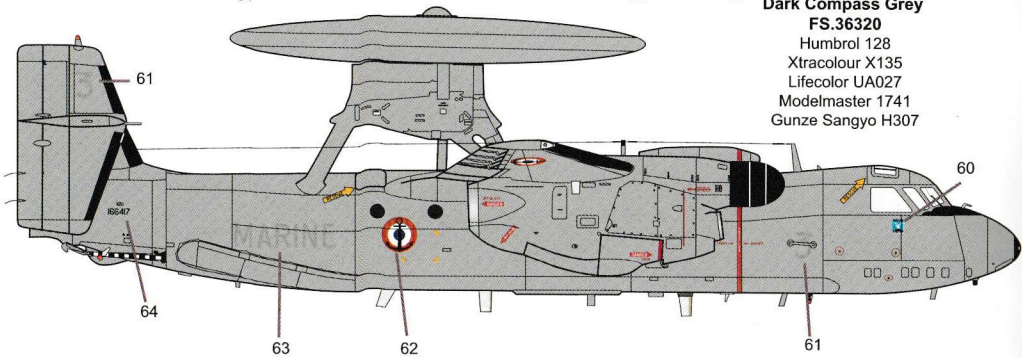

Dark Compass Grey
FS.36320
Humbrol 128
Xtracolour X135
Lifecolor UA027
Modelmaster 1741
Gunze Sangyo H307



UAE F-16F Photos by JV Aviation



Tornado IDS '154' Gruppo via Italian Air Force



F-16F Photo above via USAF Nellis AFB



German AF Eurofighter Photos by Simov Svetlan

Eurofighter EF-2000 Typhoon T 30+17 / GT0008 of Jagdgeschwader 73 "Steinhoff", based at Laage, Germany, in 2008.

Use main aircraft stencils from Revell decal sheet in both scales

Bird emblem faces forwards.

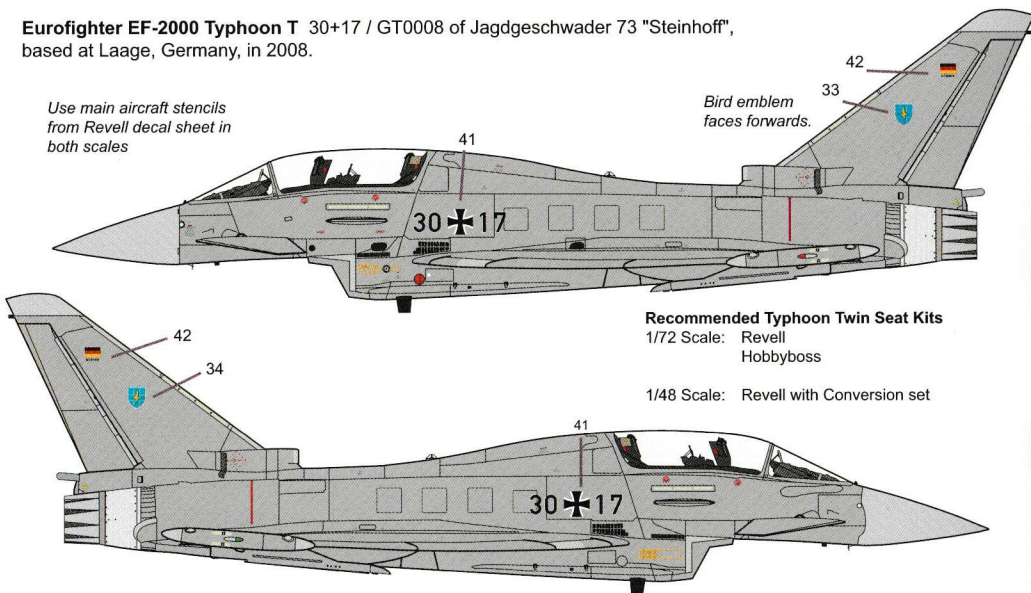

Recommended Typhoon Twin Seat Kits

1/72 Scale: Revell Hobbyboss

1/48 Scale: Revell with Conversion set

Light Ghost Grey
FS.35237
Humbrol 145
Xtracolour X126
Lifecolor UA145
Modelmaster 1721
Tamiya XF20
Gunze Sangyo H337
White Ensign RN-08

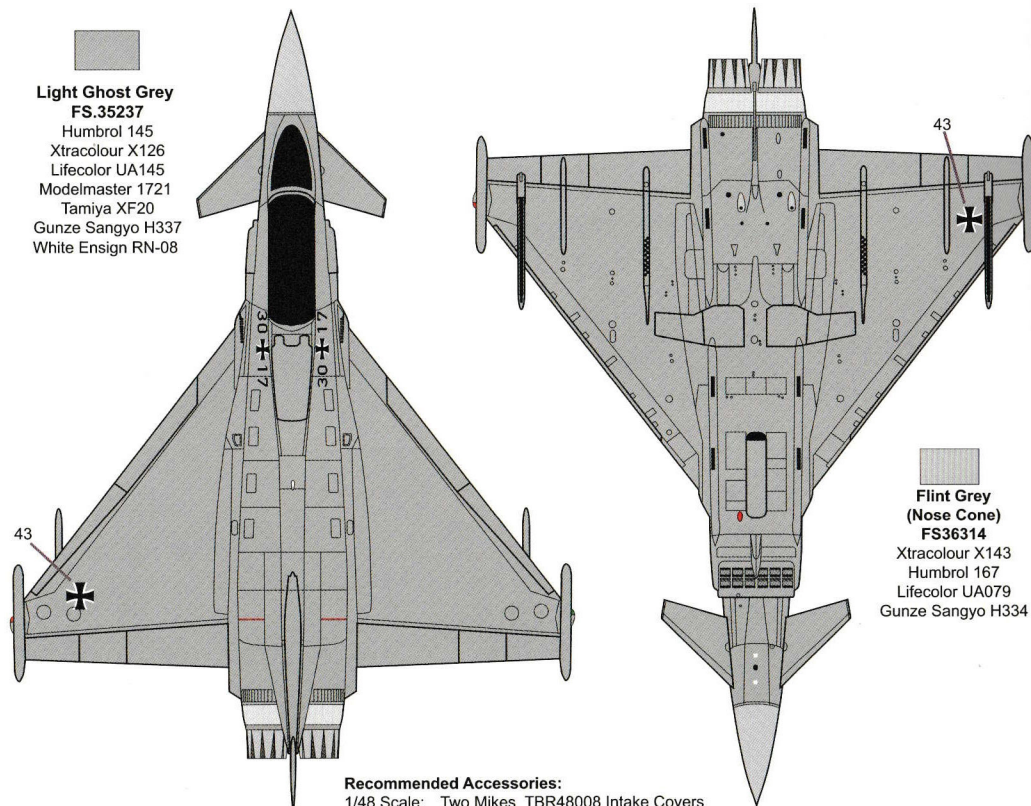

Flint Grey (Nose Cone)
FS36314
Xtracolour X143
Humbrol 167
Lifecolor UA079
Gunze Sangyo H334

Recommended Accessories:

1/48 Scale: Two Mikes TBR48008 Intake Covers
Two Mikes TBR48009 APU Exhaust
Airwaves Martin Baker Mk.16 Ejector seat

Eurofighter EF-2000 Typhoon T 30+20 / GT0009 of Jagdgeschwader 73 "Steinhoff", based at Laage, Germany, in 2009. It was specially marked to celebrate the unit's 50th anniversary and the fifth year of operation of the Eurofighter.

Use main aircraft stencils from Revell decal sheet in both scales

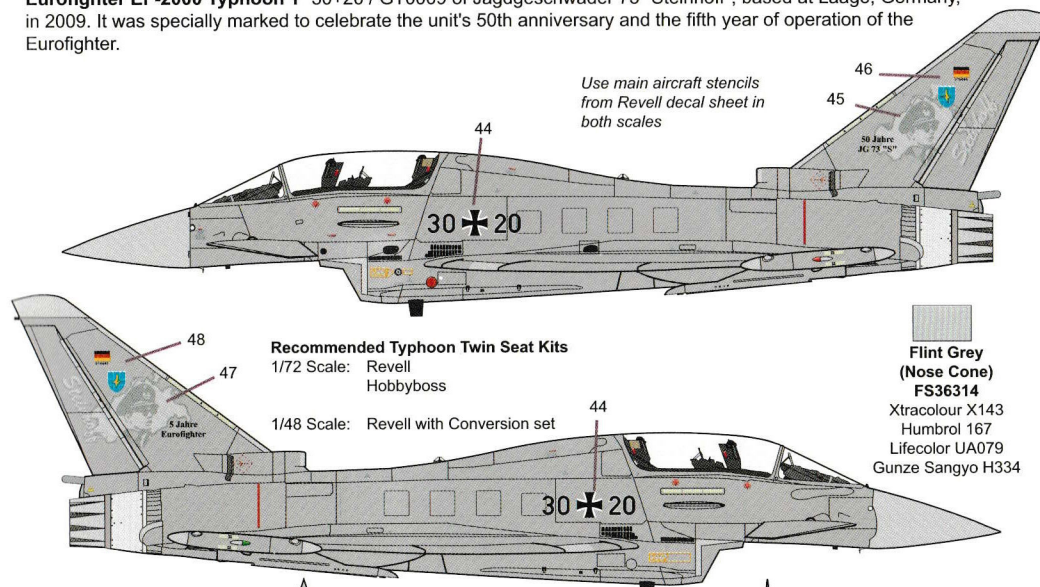

Recommended Typhoon Twin Seat Kits

1/72 Scale: Revell Hobbyboss

1/48 Scale: Revell with Conversion set

Flint Grey (Nose Cone)
FS36314
Xtracolour X143
Humbrol 167
Lifecolor UA079
Gunze Sangyo H334

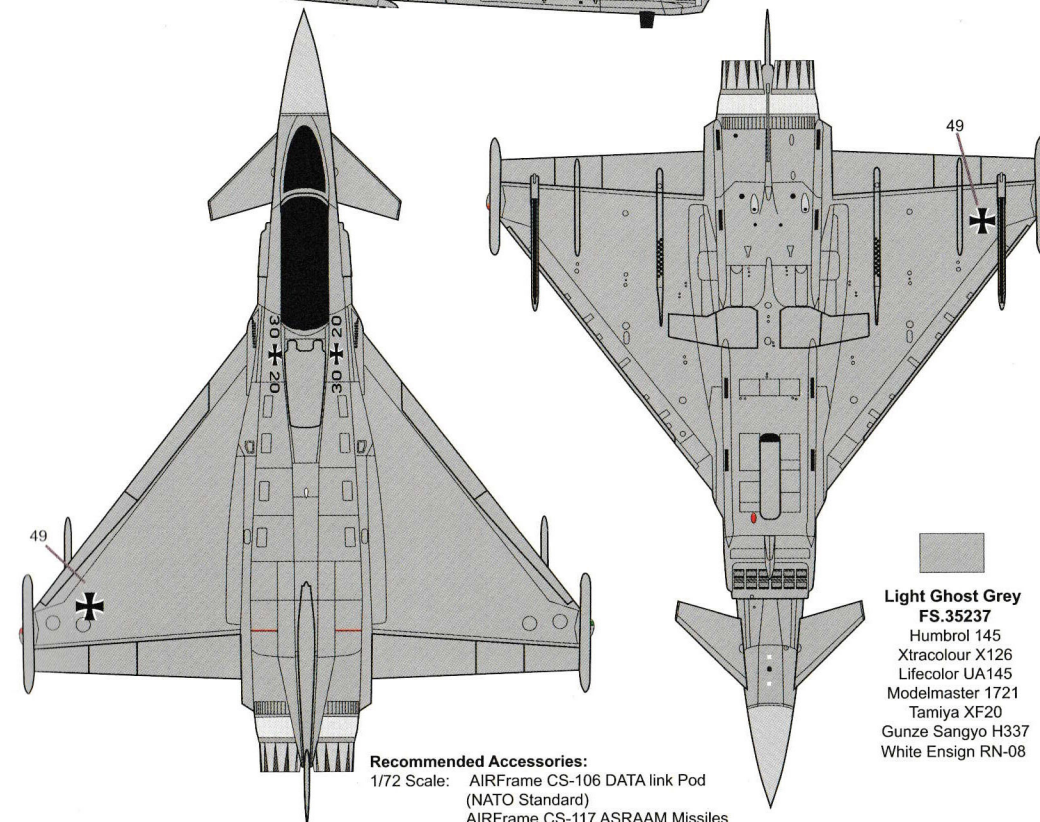

Light Ghost Grey
FS.35237
Humbrol 145
Xtracolour X126
Lifecolor UA145
Modelmaster 1721
Tamiya XF20
Gunze Sangyo H337
White Ensign RN-08

Recommended Accessories:

1/72 Scale: AIRFrame CS-106 DATA link Pod (NATO Standard)
AIRFrame CS-117 ASRAAM Missiles
Pavla S72- 047 Martin Baker Mk.16 Ejector Seat
Pavla C72-064 Twin Seat Cockpit set
Two Mikes Resin TBR72001 Intake Covers



VH-60 Photos via USMC/DoD



French Navy Hawkeye Photo right by Robin Powney



RAAF F/A-18 Photos by Phil Vabre

French Navy Hawkeye Photo below and below right via French Navy.

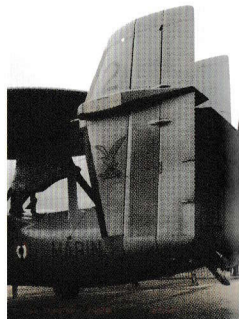

Eurofighter EF-2000 Typhoon S 30+33 / GS0021 of Jagdgeschwader 74, based at Neuburg, Germany, in 2008.

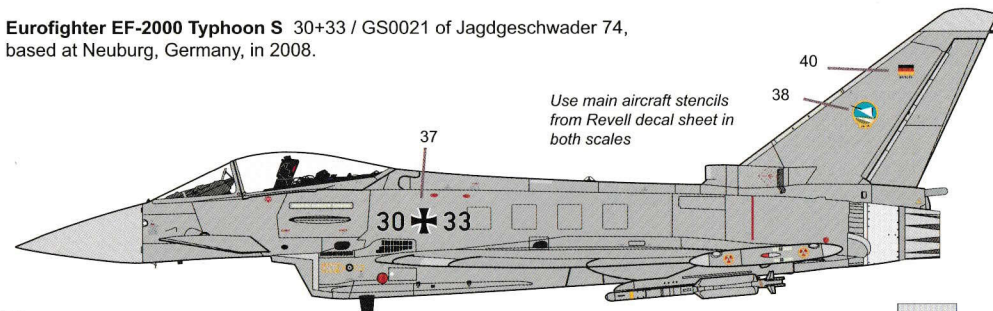

Use main aircraft stencils from Revell decal sheet in both scales

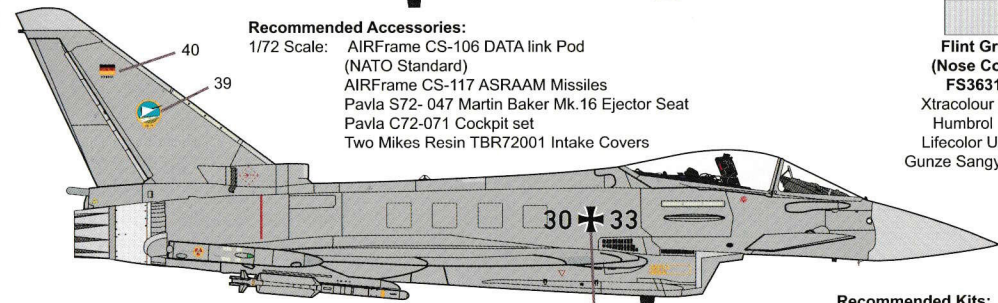

Recommended Accessories:

- 1/72 Scale: AIRFrame CS-106 DATA link Pod (NATO Standard)
- AIRFrame CS-117 ASRAAM Missiles
- Pavla S72- 047 Martin Baker Mk.16 Ejector Seat
- Pavla C72-071 Cockpit set
- Two Mikes Resin TBR72001 Intake Covers

- Flint Grey (Nose Cone)** FS36314
- Xtracolor X143
- Humbrol 167
- Lifecolor UA079
- Gunze Sangyo H334

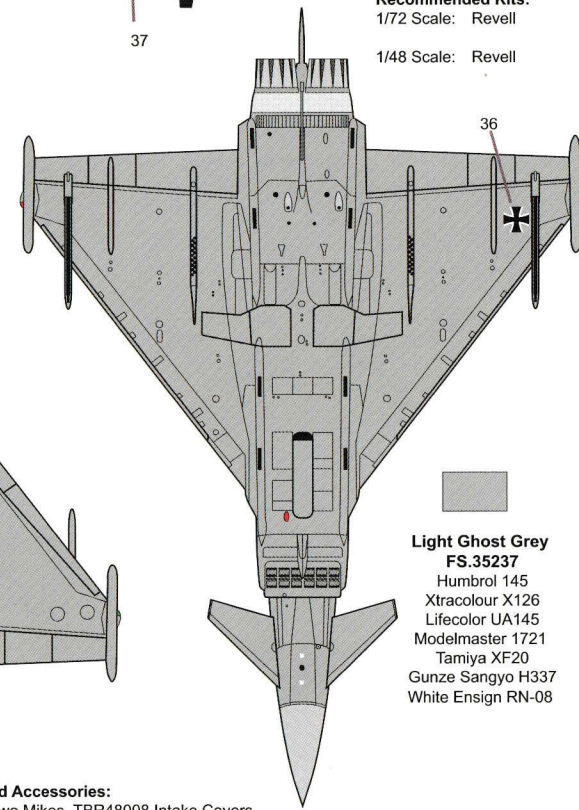
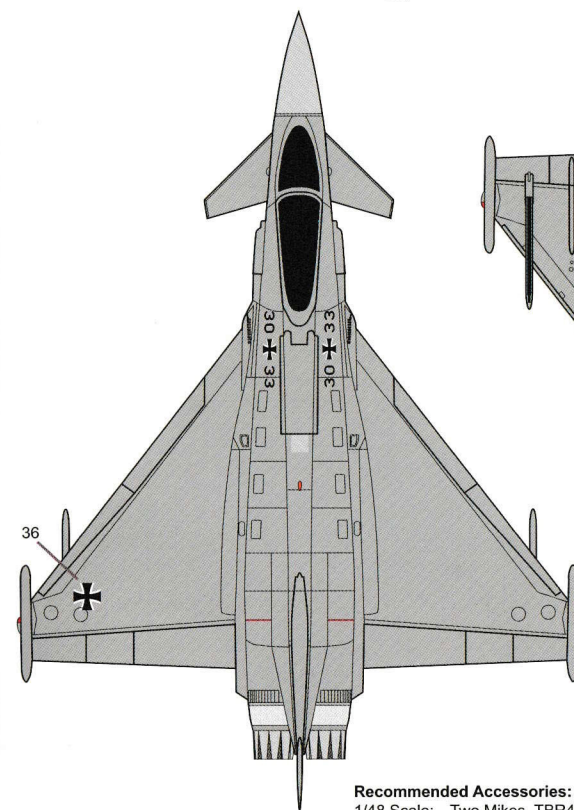

Recommended Kits:

- 1/72 Scale: Revell
- 1/48 Scale: Revell

- Light Ghost Grey** FS.35237
- Humbrol 145
- Xtracolor X126
- Lifecolor UA145
- Modelmaster 1721
- Tamiya XF20
- Gunze Sangyo H337
- White Ensign RN-08

Recommended Accessories:

- 1/48 Scale: Two Mikes TBR48008 Intake Covers
- Two Mikes TBR48009 APU Exhaust
- Airwaves Martin Baker Mk.16 Ejector seat

Eurofighter EF-2000 Typhoon S 30+47 / GS0032 of Jagdgeschwader 73 "Steinhoff", based at Laage, Germany, in 2008.

Use main aircraft stencils from Revell decal sheet in both scales

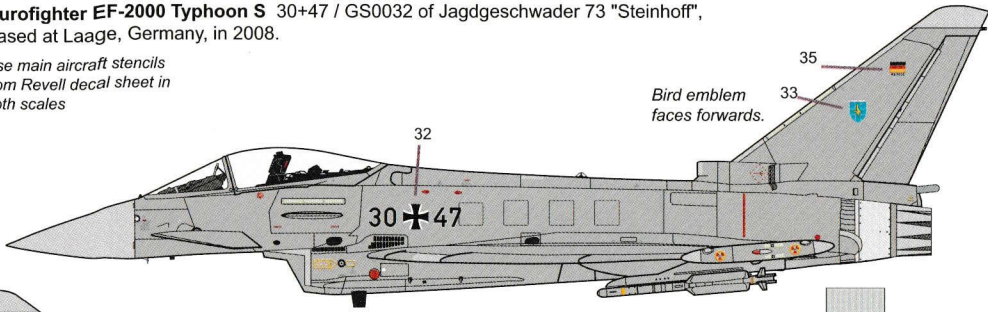

Bird emblem faces forwards.

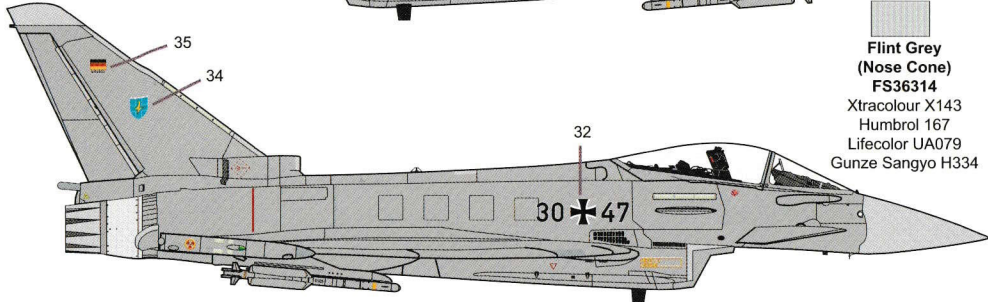

Flint Grey (Nose Cone)
FS36314
 Xtracolour X143
 Humbrol 167
 Lifecolor UA079
 Gunze Sangyo H334

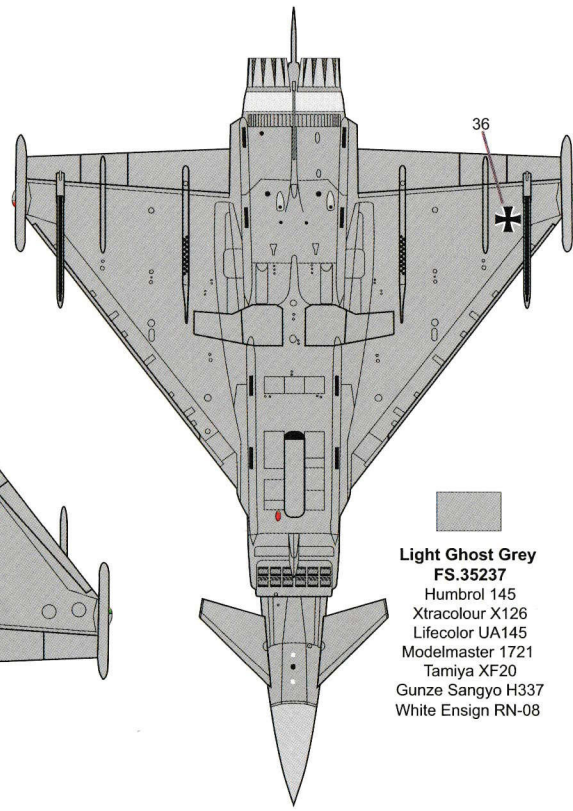
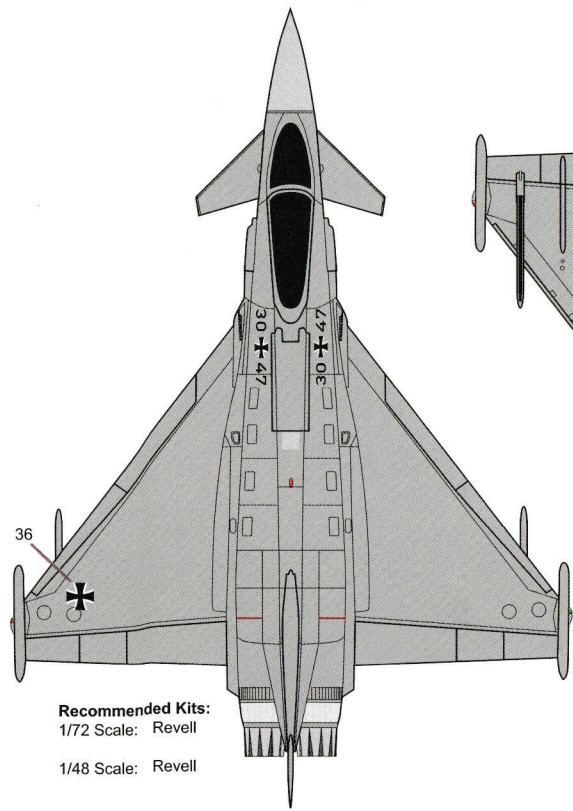

Light Ghost Grey
FS.35237
 Humbrol 145
 Xtracolour X126
 Lifecolor UA145
 Modelmaster 1721
 Tamiya XF20
 Gunze Sangyo H337
 White Ensign RN-08

Recommended Kits:
 1/72 Scale: Revell
 1/48 Scale: Revell

McDonnell Douglas F/A-18A Hornet HUG A21-13 of 3 Squadron RAAF, based at RAAF Williamtown, New South Wales, in 2006.

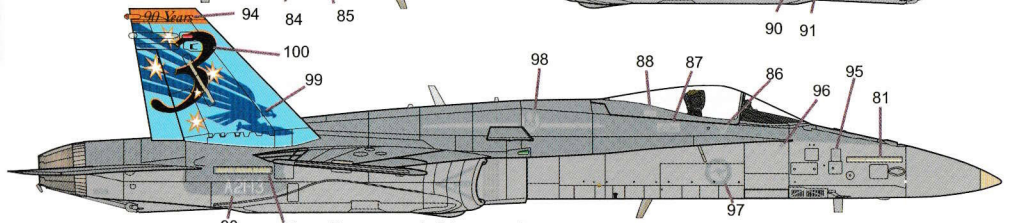
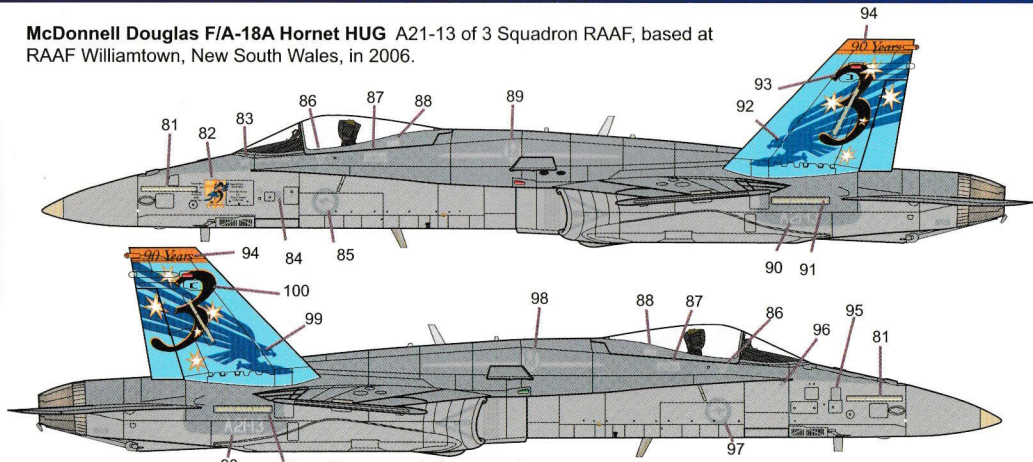

Recommended Accessories:
 1/72 Scale AIRFrame Extra CS-106 DATA Link Pod
 AIRFrame Extra CS-116 Paveway II Smart Bombs
 AIRFrame Extra CS-117 AIM32 ASRAAM Missiles
 AIRFrame Extra CS-129 Hornet extended refuelling Probe
 AIRFrame Extra CS-144 Litening III Pod

Blue Grey
FS35237
 Humbrol 145
 Xtracolour X126
 Lifecolor UA145
 Modelmaster 1721
 Gunze Sangyo H337

Blue
(Near match)
FS25466
 Model Color 67
 Andrea Color 20
 Vallejo Model Color 961

Orange
FS22197
 Humbrol 18
 Lifecolor LC55
 Modelmaster 1527
 Gunze Sangyo H14

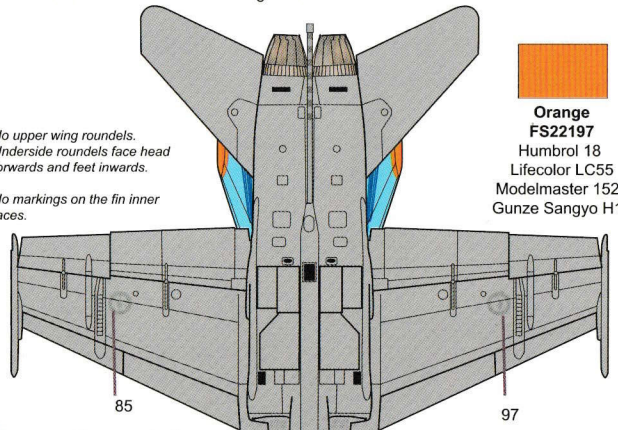
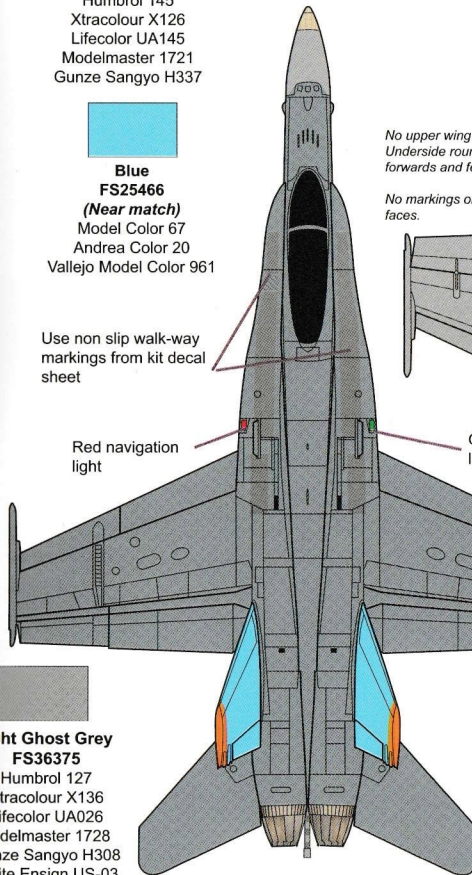

Light Ghost Grey
FS36375
 Humbrol 127
 Xtracolour X136
 Lifecolor UA026
 Modelmaster 1728
 Gunze Sangyo H308
 White Ensign US-03

Radome Tan
FS33613
 Humbrol 148
 Xtracolour X107
 Modelmaster 1709
 Gunze Sangyo H318

Recommended Kits:
 1/72 Scale: Academy F/A-18A
 Hasegawa F/A-18A
 Fujimi F/A-18A
 1/48 Scale: Hasegawa F/A-18A
 Hobbyboss F/A-18A

Note* Although the Australian Hornets are to the same standard as the F/A-18C, the only modification to the A model is the small modification to the nose strakes in front of the canopy.

Lockheed Martin F-16F (Block 60) "Desert Falcon" 3002 of 1 Squadron, based at Al Dhafra AB, United Arab Emirates, in 2008.

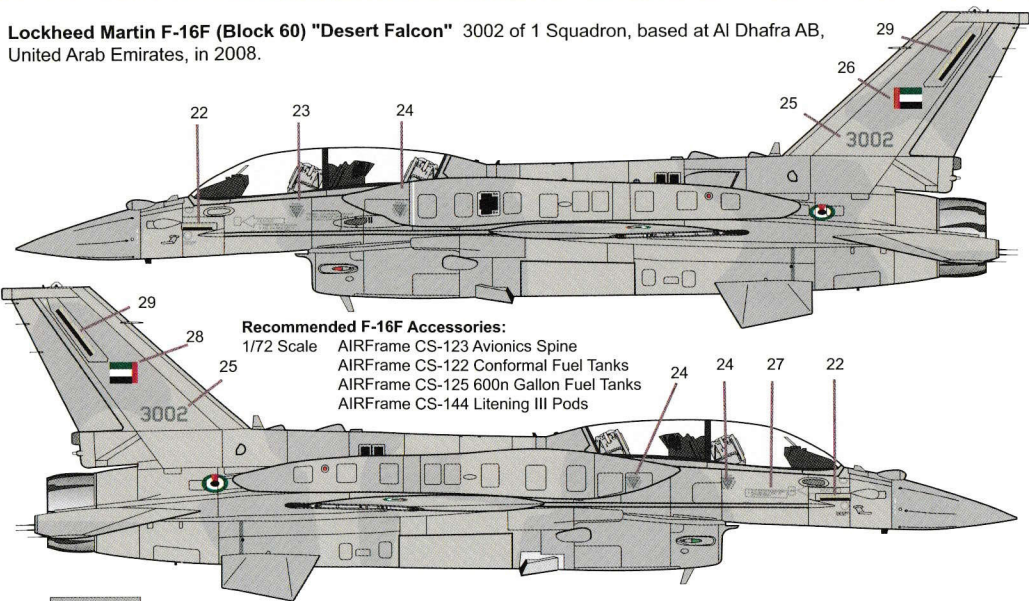

Recommended F-16F Accessories:

- 1/72 Scale AIRFrame CS-123 Avionics Spine
- AIRFrame CS-122 Conformal Fuel Tanks
- AIRFrame CS-125 600n Gallon Fuel Tanks
- AIRFrame CS-144 Litening III Pods

Light Ghost Grey
FS.36375

- Humbrol 127
- Xtracolour X136
- Lifecolor UA026
- Modelmaster 1728
- Gunze Sangyo H308
- White Ensign US-03

Recommended F-16F Kits:

- 1/72 Scale Hasegawa (Limited Edition)
- Revell with Modification
- Hasagawa F-16D with conversion
- Kinetic (New 2010)

- 1/48 Scale: Hasegawa
- Kinetic

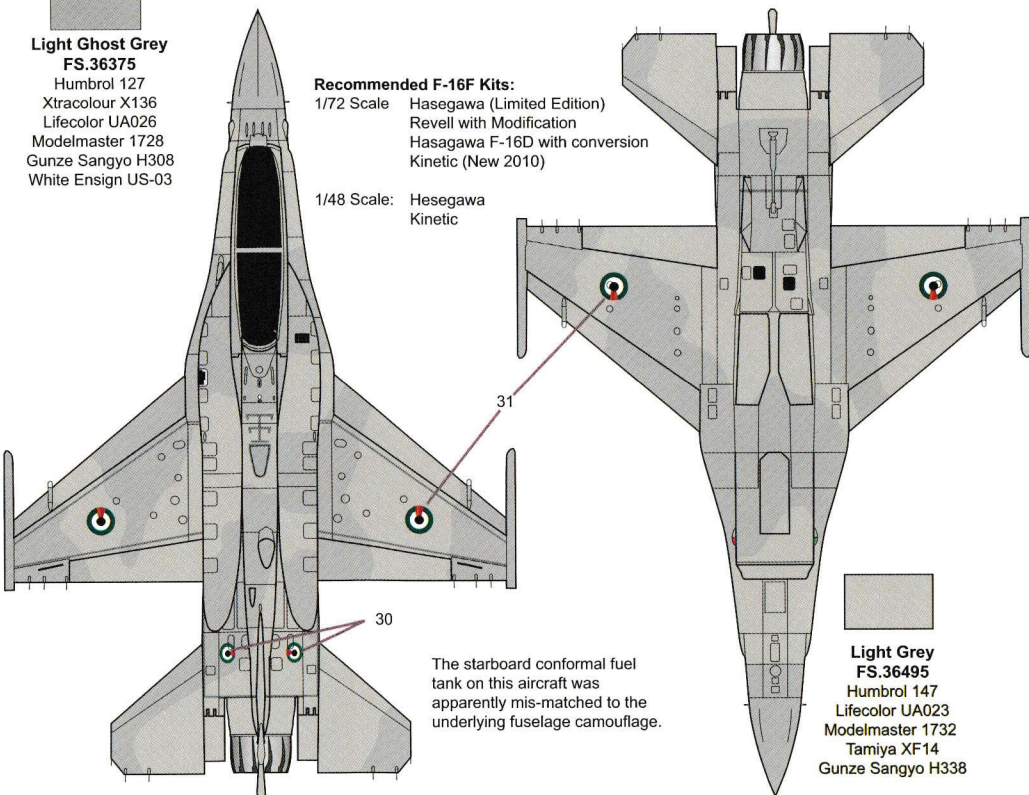

The starboard conformal fuel tank on this aircraft was apparently mis-matched to the underlying fuselage camouflage.

Light Grey
FS.36495

- Humbrol 147
- Lifecolor UA023
- Modelmaster 1732
- Tamiya XF14
- Gunze Sangyo H338

Sikorski VH-60N Whitehawk 163266 of the Executive Flight Detachment of HMX-1, based at MCAF Quantico, Virginia, in 2008.

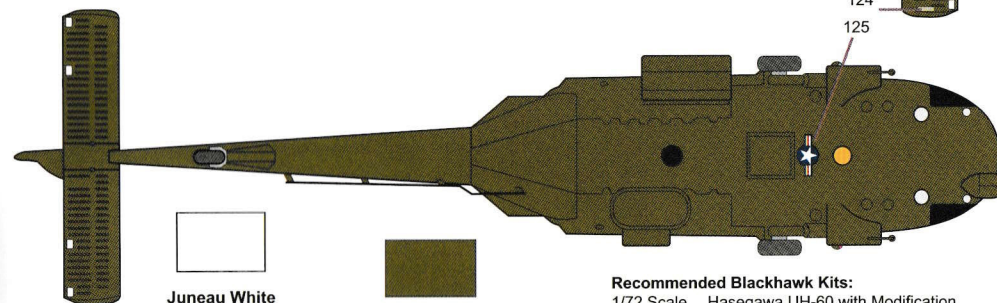
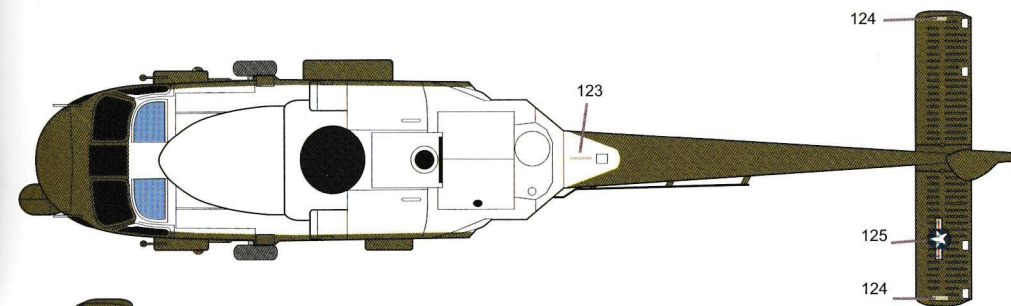
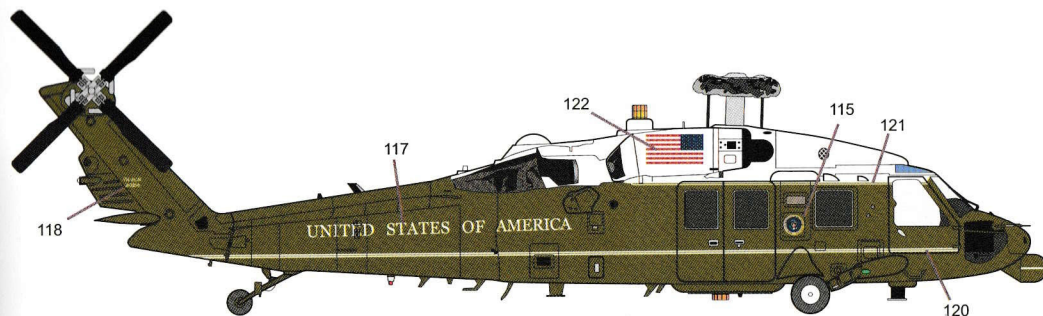
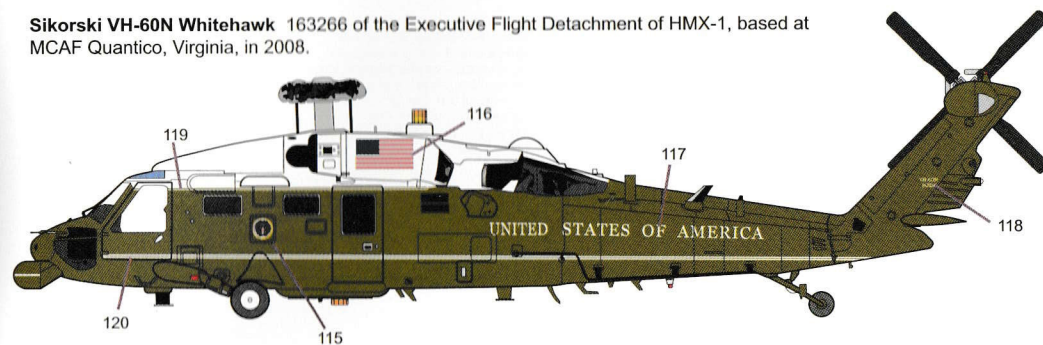

Juneau White
FS.17875

- Humbrol 22
- Xtracolour X141
- Lifecolor LC01
- Modelmaster 1745
- Tamiya X2
- Gunze Sangyo H1
- White Ensign US-10

Presidential Olive Green
FS.14079

- Humbrol 116
- Xtracolour X110
- Lifecolor UA052
- Modelmaster 1710
- Tamiya XF58

Recommended Blackhawk Kits:

- 1/72 Scale Hasegawa UH-60 with Modification
- Hobbyboss UH-60 with Modification

- 1/48 Scale: Italeri with Modification
- Minicraft with Modification

Recommended Accessories:

- 1/72 Scale: AIRFrame CS-169 Conversion Set