

1/35 MILITARY MINIATURE VEHICLE UPGRADE SERIES PEA170

Russian T-62 Medium Tank Slat Armour

俄罗斯T-62中型坦克附加栅栏

[For TRUMPETER]

推荐使用工具 RECOMMENDED TOOLS

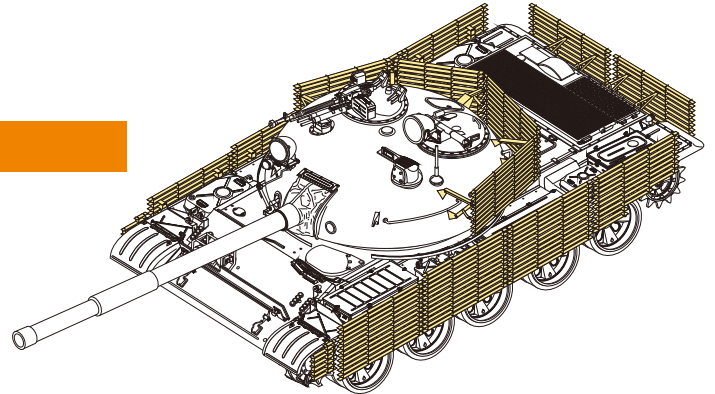
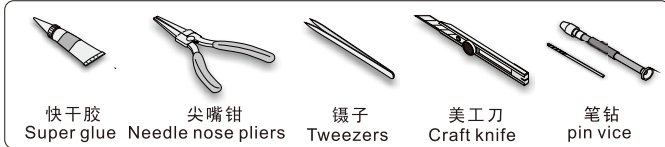

- ↑
安装
install
- ↩
折叠
bend
- A1
改造件零件编号
PE/resin part number
- B12
原零件编号
kit part number
- C22
被替换的原零件编号
replaced kit part number
- ↔
另一侧相同制作
repeat on opposite side
- ✂
切除
remove
- ⚠
注意
caution
- 📐
弧度卷曲
radial bending
- x2
制作若干组
multiple assembly
- ⇄
选择安装
alternative
- 🔪
钻孔
drill
- 📌
用胶棒制作
make from plastic rod

↓
用尖端在凹槽处冲压
use penpoint to press on the dent

刻划片零件内侧面
Put the part upside down

用笔尖在凹槽处划
Use penpoint to press on the dent

a

安装栅栏示例
Typical installation
Slat Armour

b

c

d

e

VOYAGERMODEL® 无微不至 精益求精

Recommended item

PE 35282	Russian T-62 Medium Tank Mod.1962
PE 35284	Russian T-62 Medium Tank Mod.1972
PE 35285	Russian T-62 Medium Tank Fenders
JO 35057	Russian T-62 Medium Tank Mod.1972
PEA 168	Russian T-62 Medium Tank Stowage Bins
PEA 202	Modern Russian AFV smoke discharger w/cover
PEA 209	Modern Russian AFV screw of antineutron layer sets
PEA 210	Modern Russian AFV antenna base set1
PEA 211	Modern Russian AFV smoke discharger

1/35 MILITARY MINIATURE VEHICLE UPGRADE SERIES PEA170

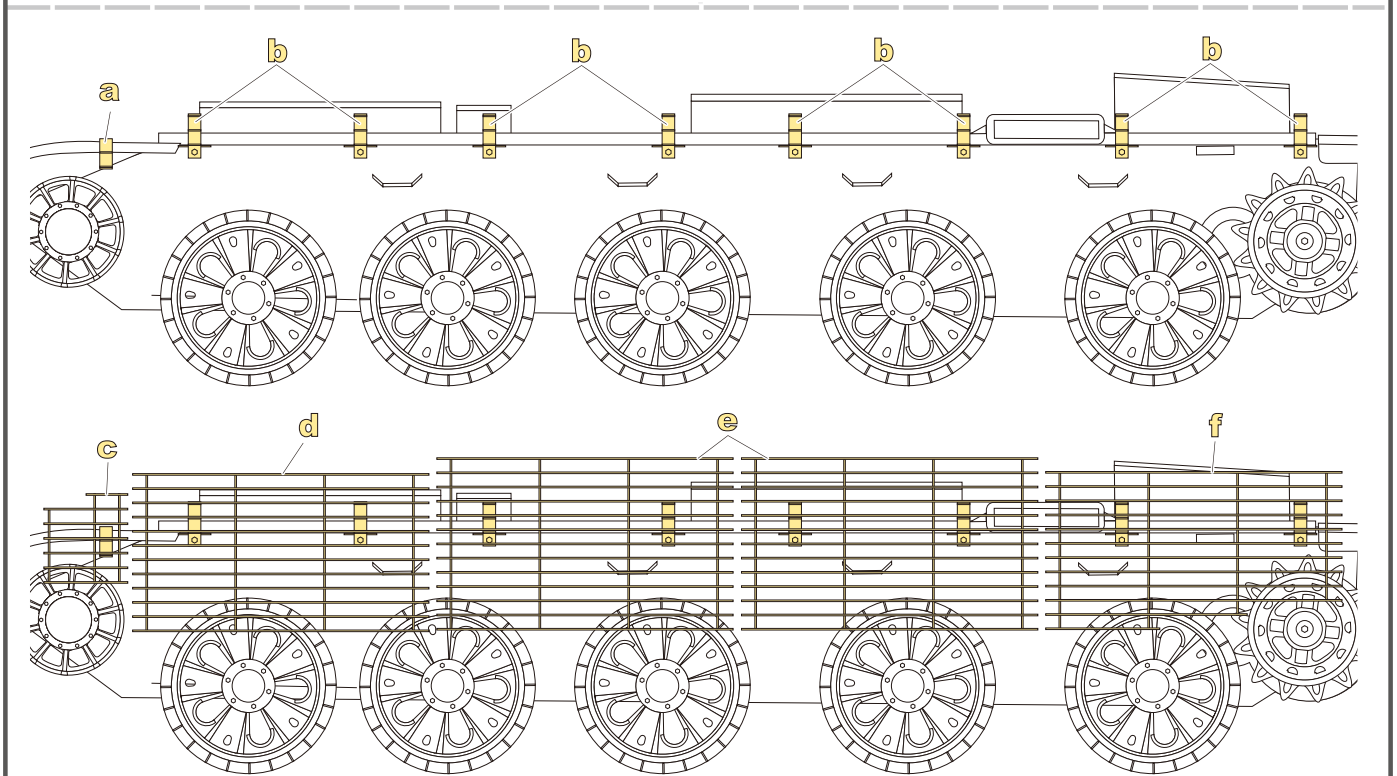
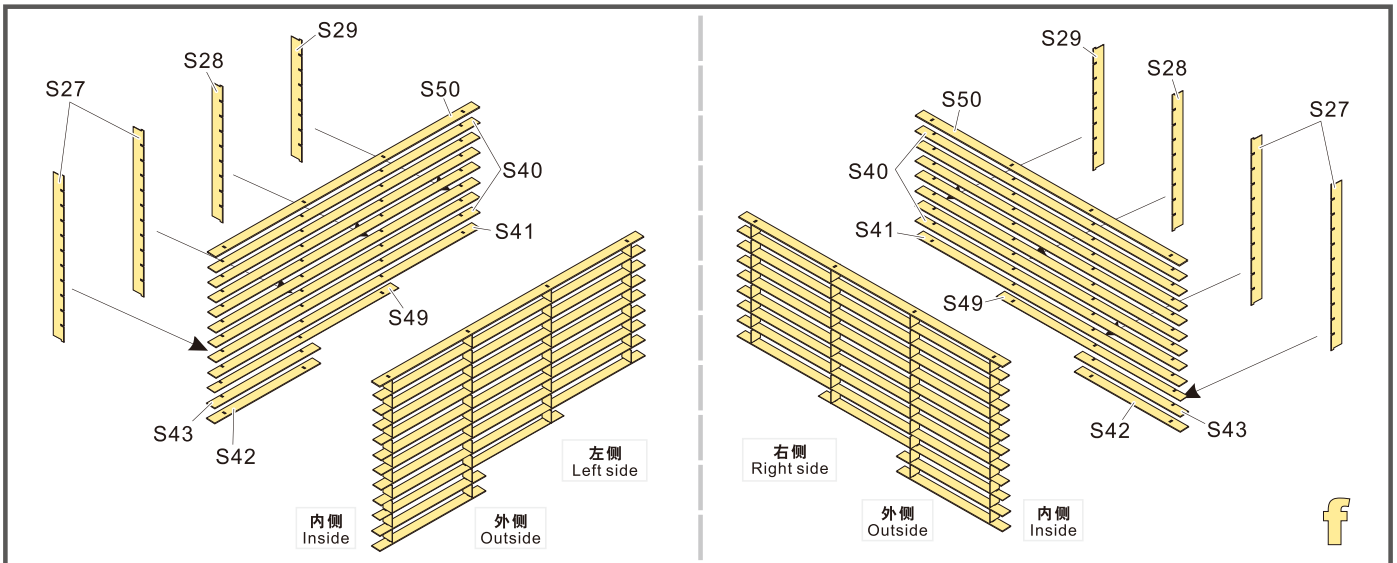

注意外侧内侧的区别
Note differences between inside/outside

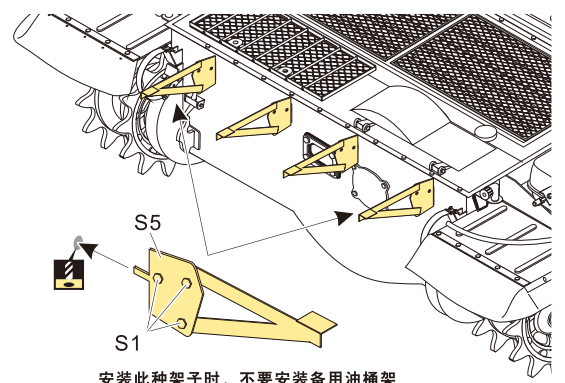
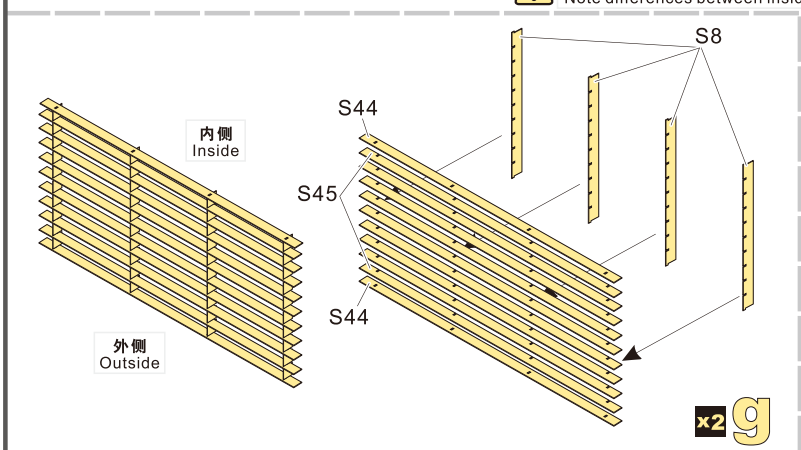

安装此种架子时，不要安装备用油桶架
Do not install fuel drum racks when installing this type of braces

1/35 MILITARY MINIATURE VEHICLE UPGRADE SERIES PEA170

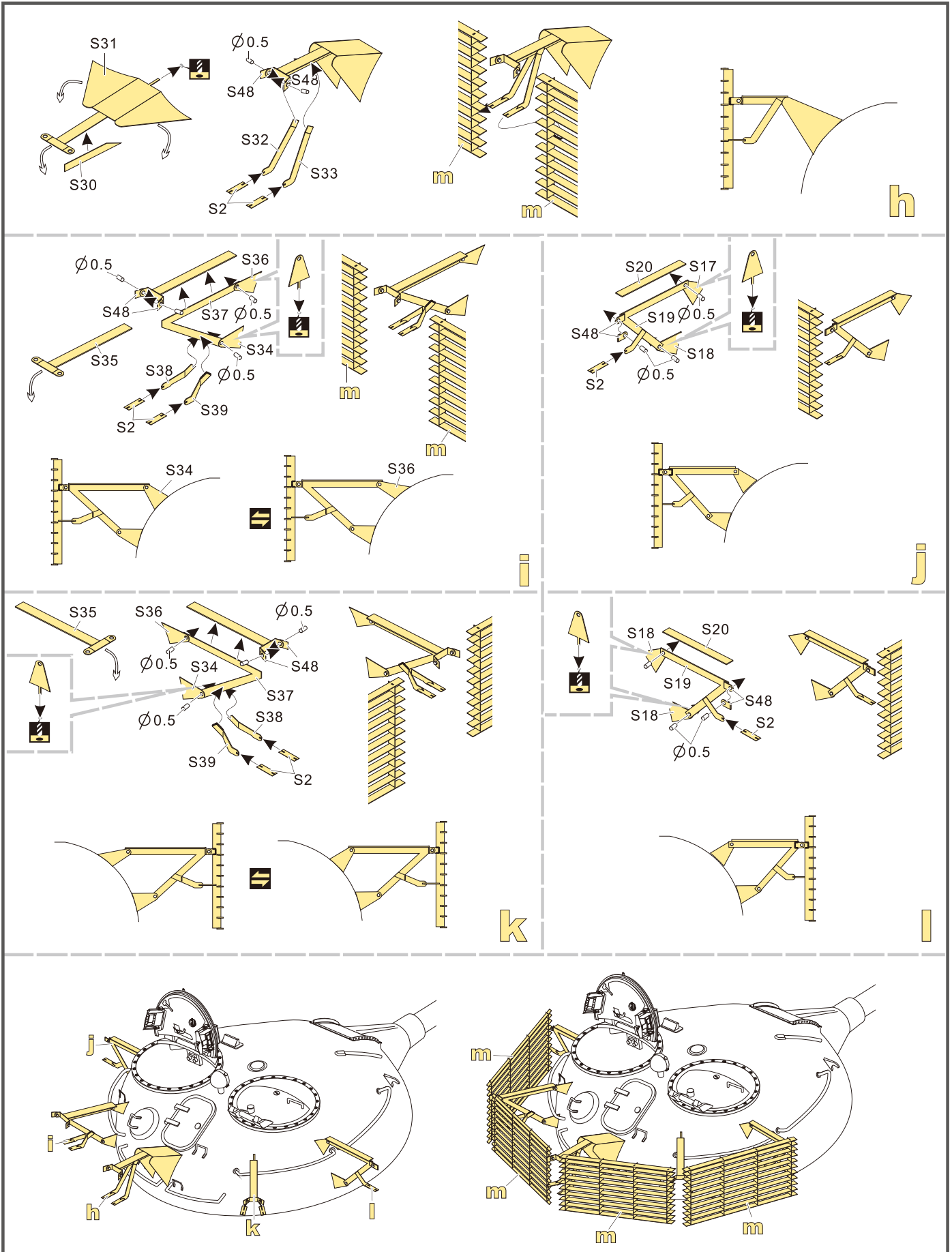

1/35 MILITARY MINIATURE VEHICLE UPGRADE SERIES PEA170

