

TETRA Model Works

www.tetramodel.com



x2



반대쪽도 조립합니다.  
repeat on the opposite side  
向こうも同じ方法でつくり直します  
対面用一样的方法也重新装

2번 조립합니다.  
Make 2 sets.  
2組つくってくださいます  
同樣制作二組

잘라냅니다.  
Remove / Cut  
切り取っています  
切去

구멍을 만듭니다.  
Make hole.  
穴あけてください  
鑽孔

누릅니다.  
Press  
押してください  
请按

선택 부품입니다.  
Optional parts  
どちらかを選んでください  
可以選擇採用

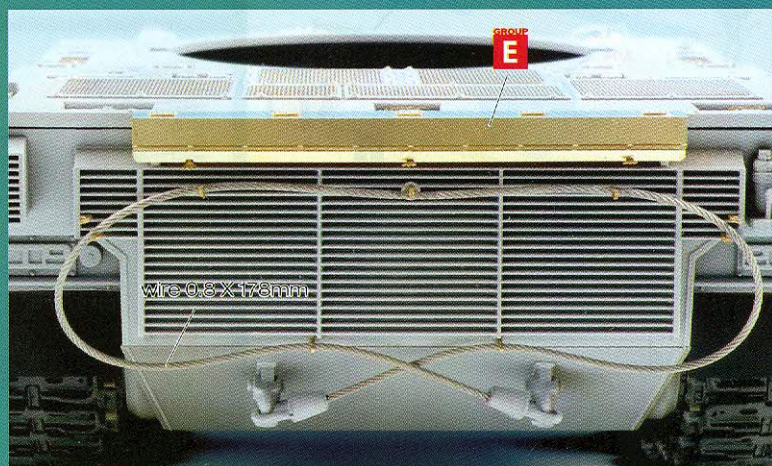
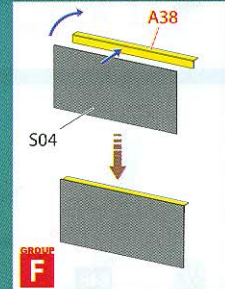
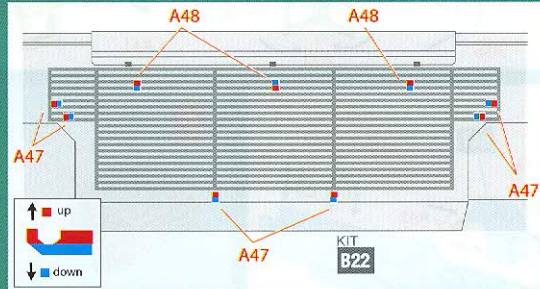
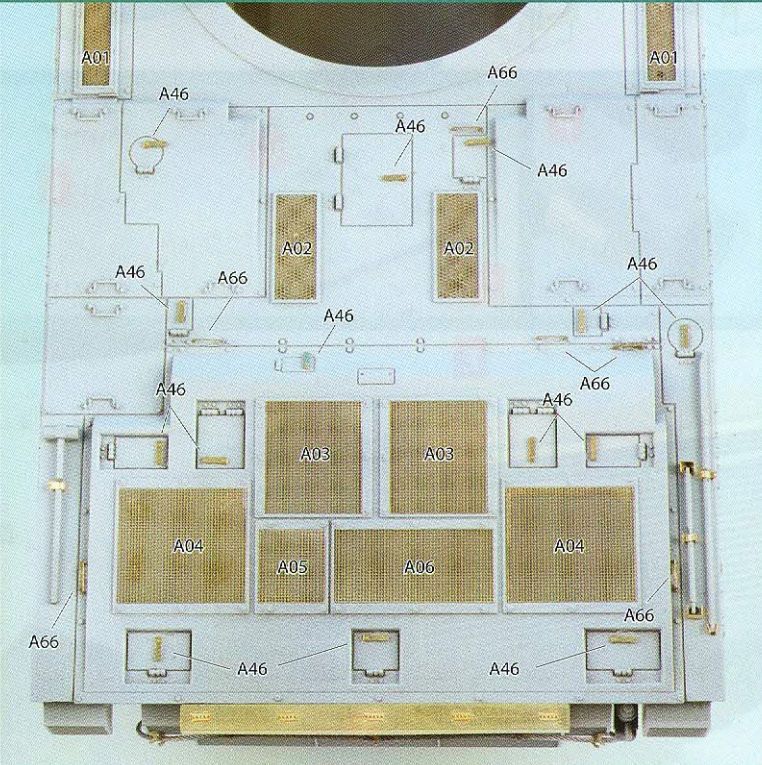
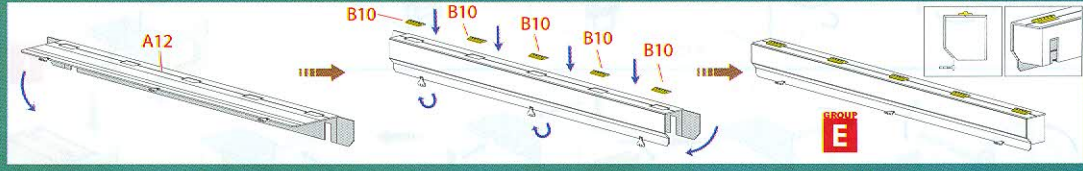
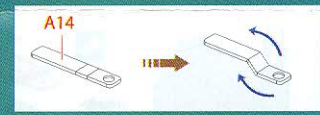
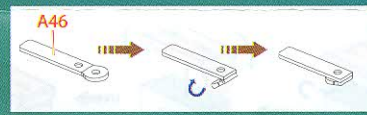
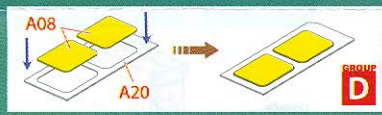
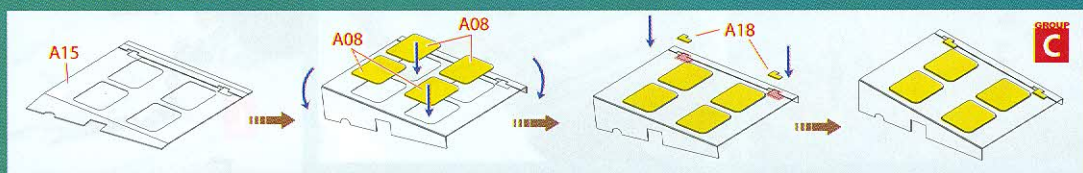
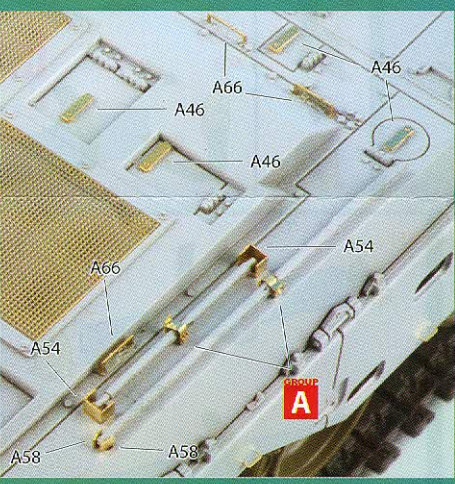
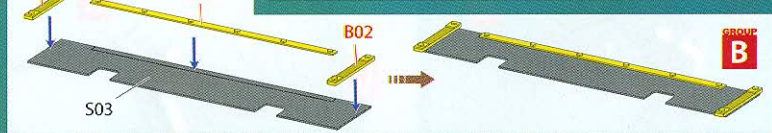
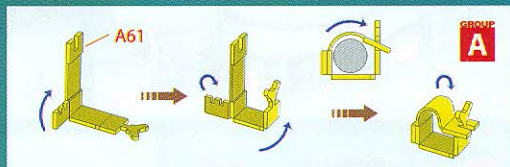
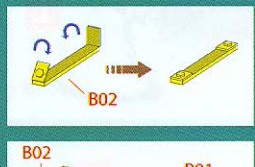
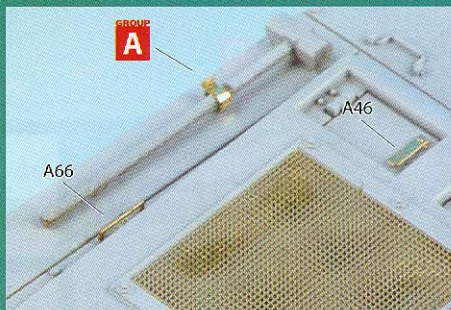
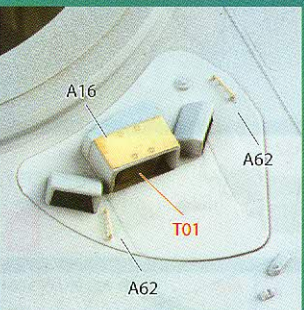
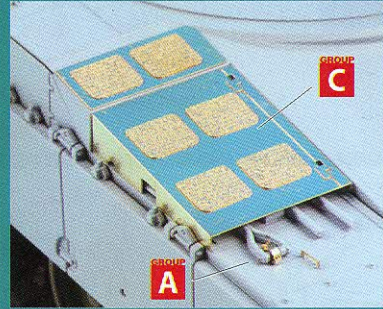
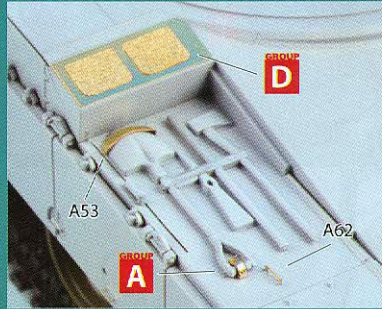
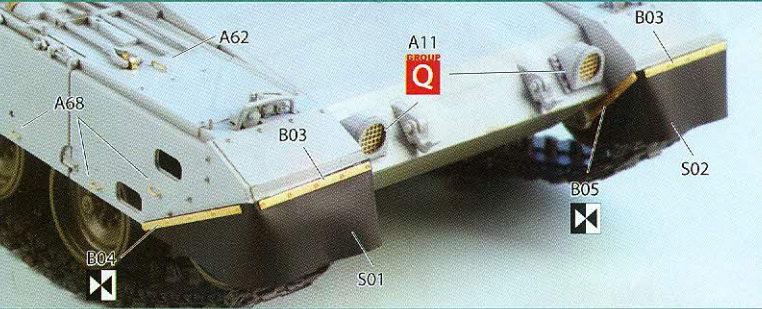



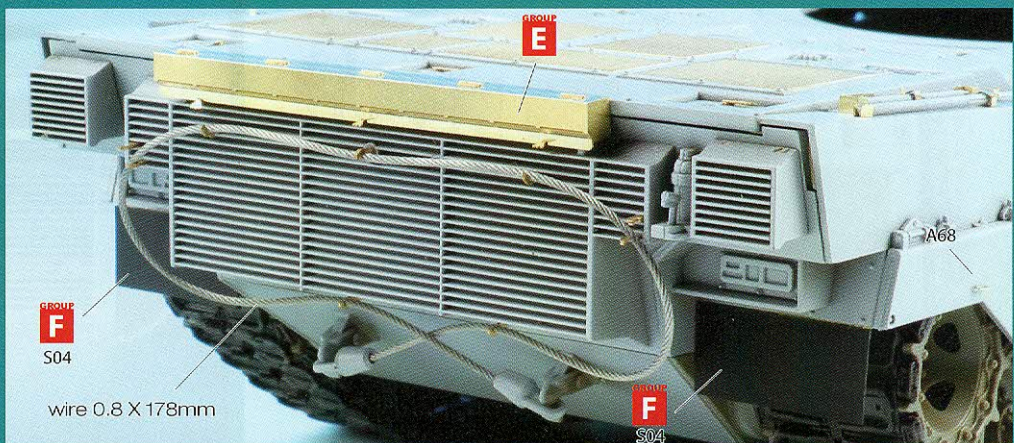
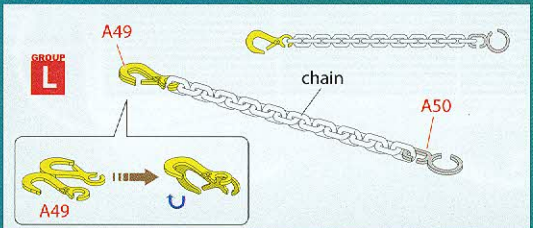
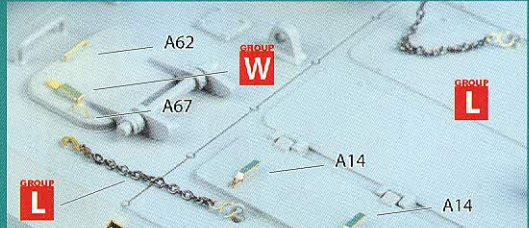
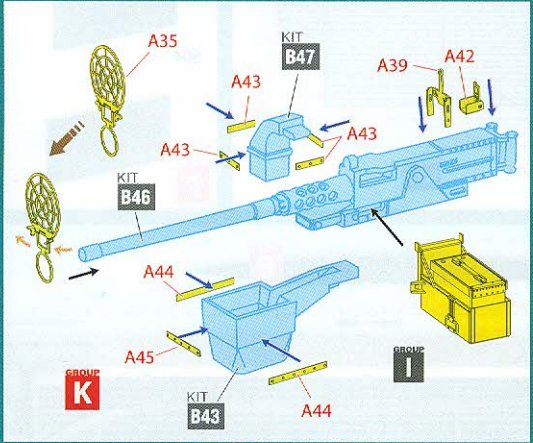
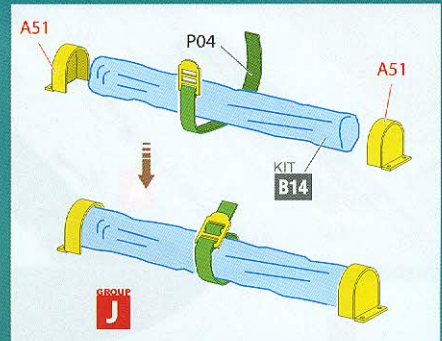
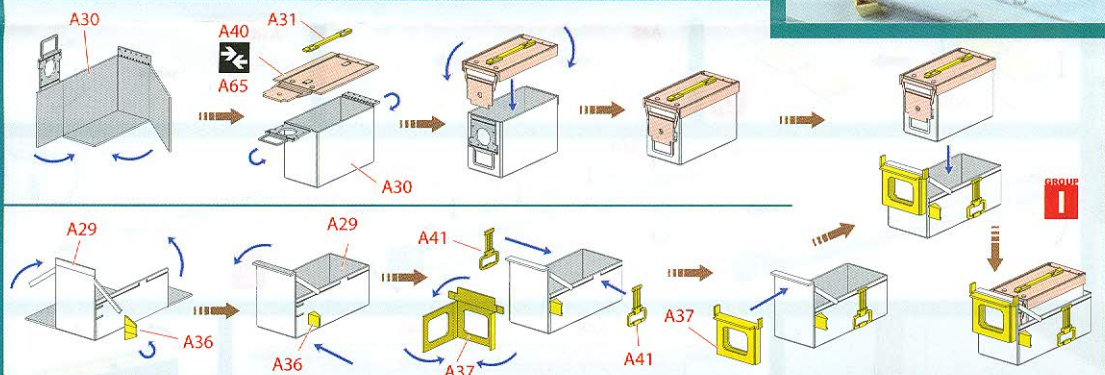
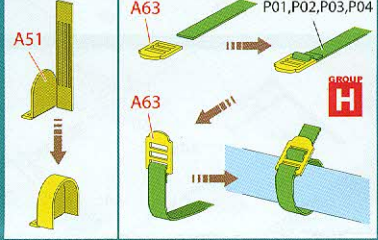
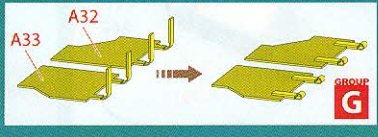
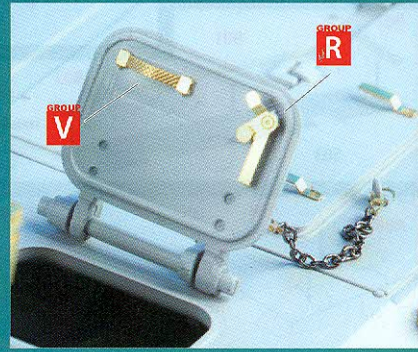
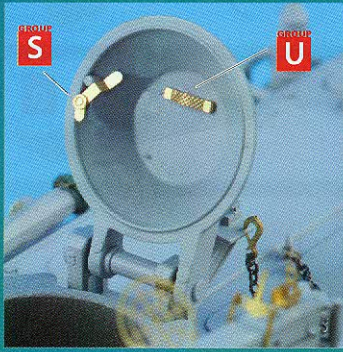
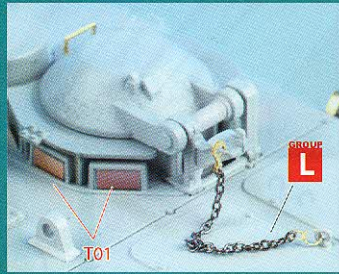
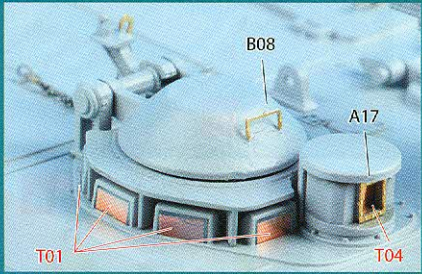
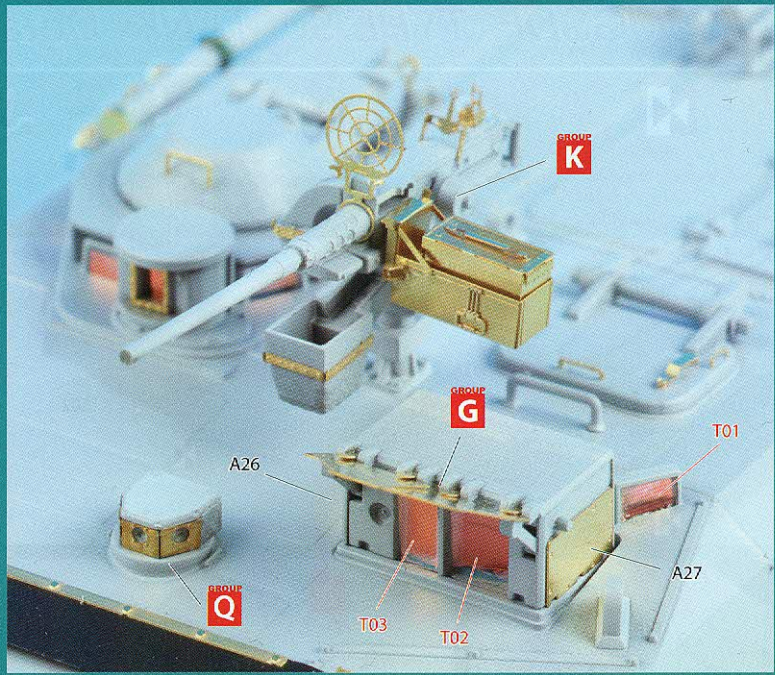
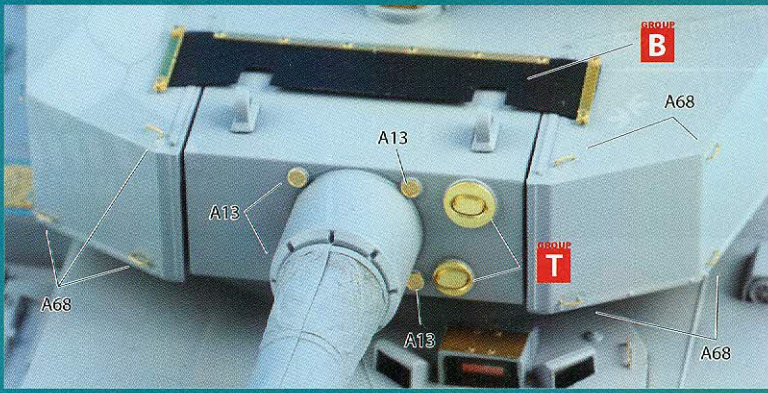



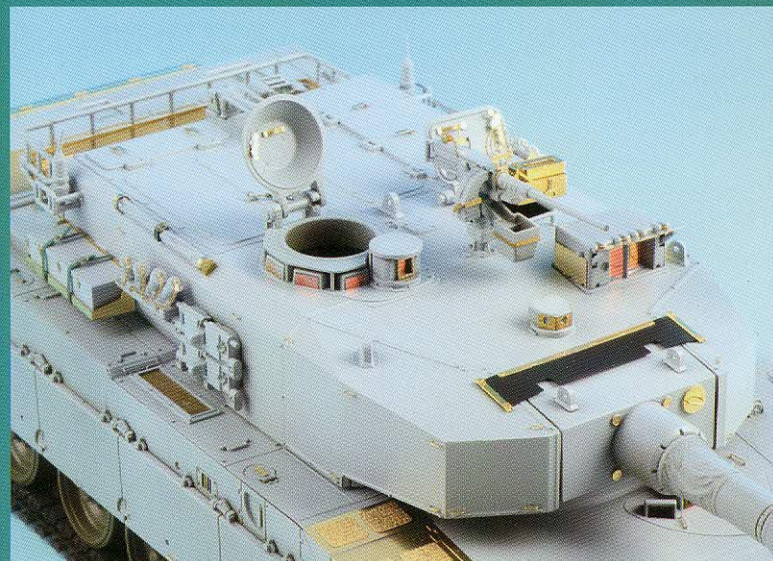
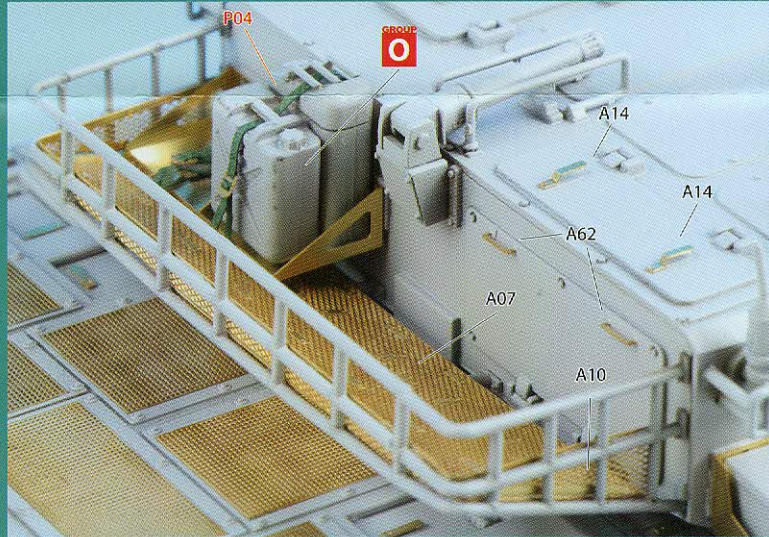
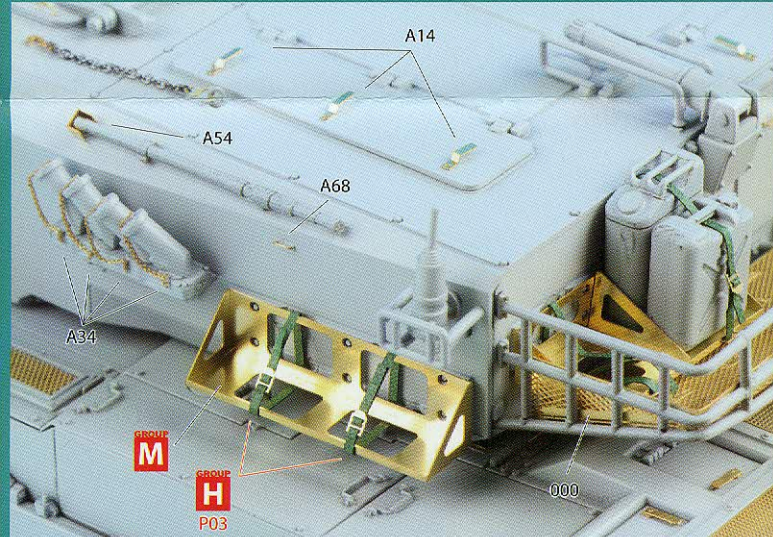
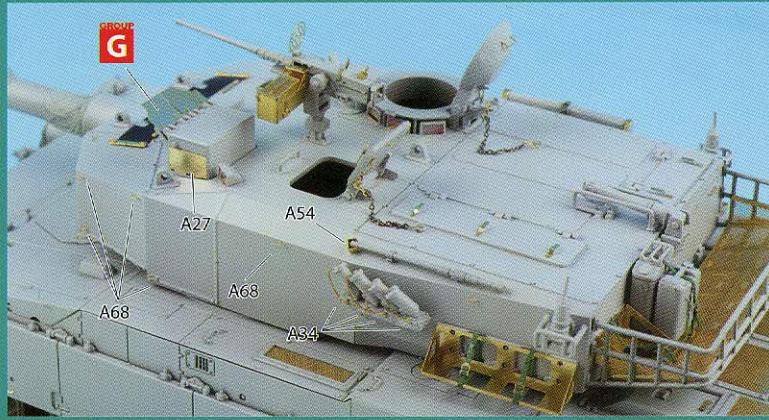
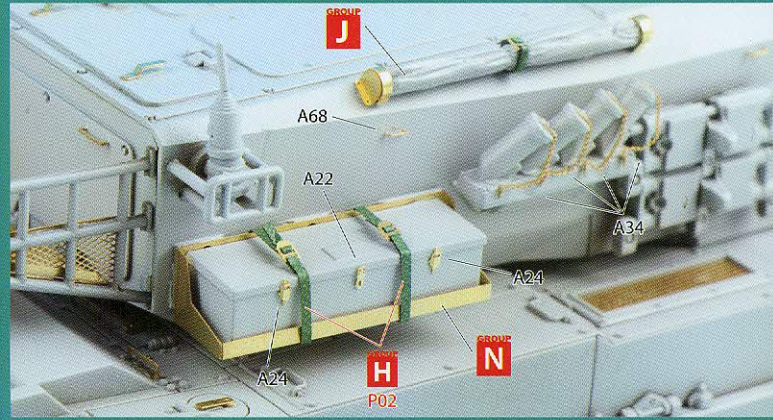
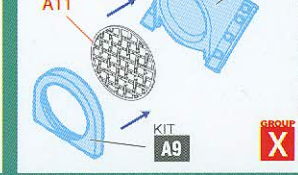
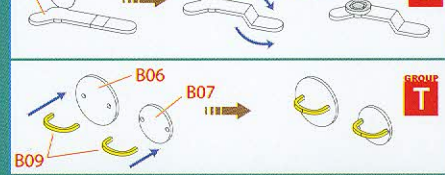
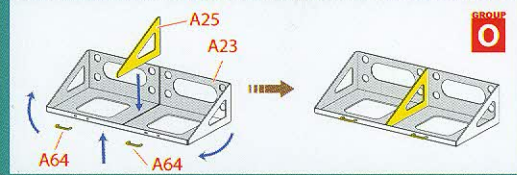
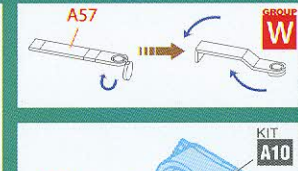
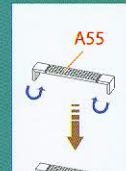
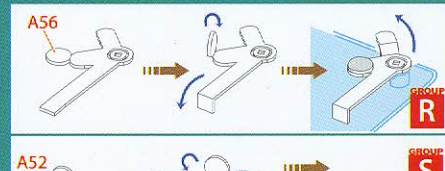
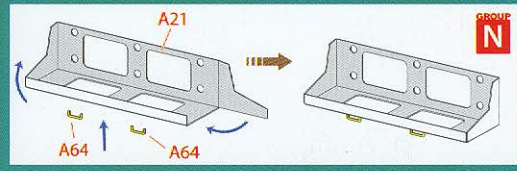
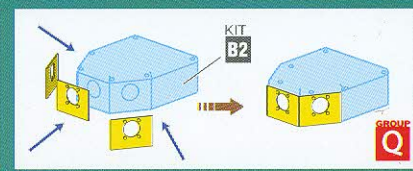
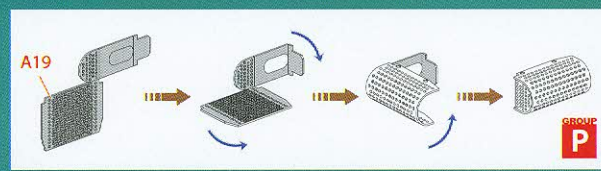
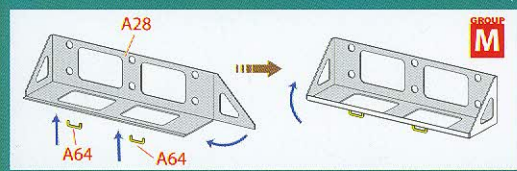

1/35 JGSDF TYPE90 (for TAMIYA)

1/35 JGSDF TYPE90 (for TAMIYA 35208)