

AVRO LANCASTER IN FRENCH SERVICE

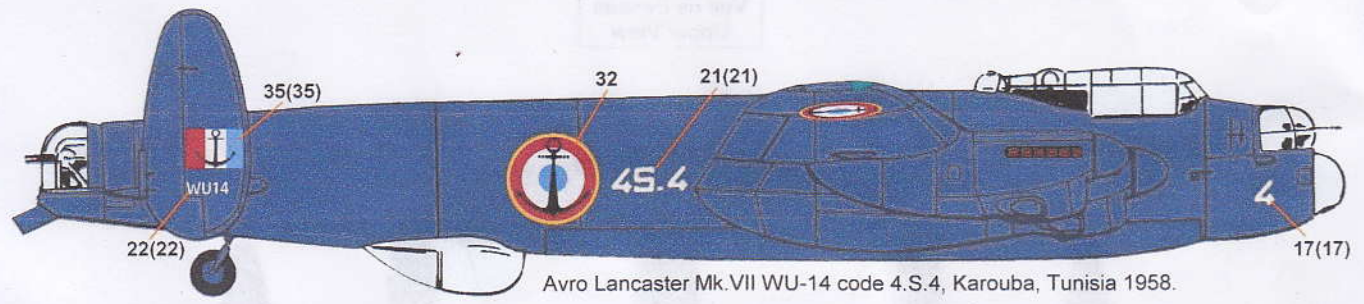

Avro Lancaster Mk.VII WU-14 code 4.S.4, Karouba, Tunisia 1958.



Avro Lancaster Mk.VII WU-09 code 55.S.10, Agadir, Morocco 1956.



Avro Lancaster Mk.VII WU-12 code 24.F.1, Lann-Bihoué, France 1953.

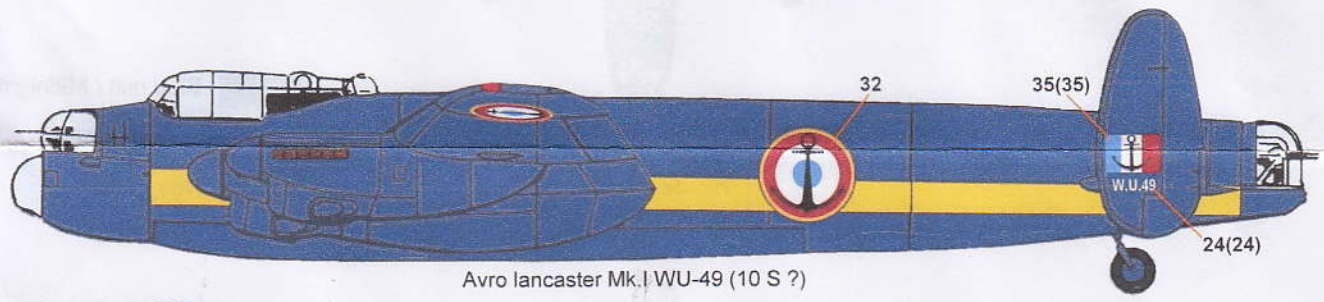

Avro Lancaster Mk.I WU-49 (10 S ?)

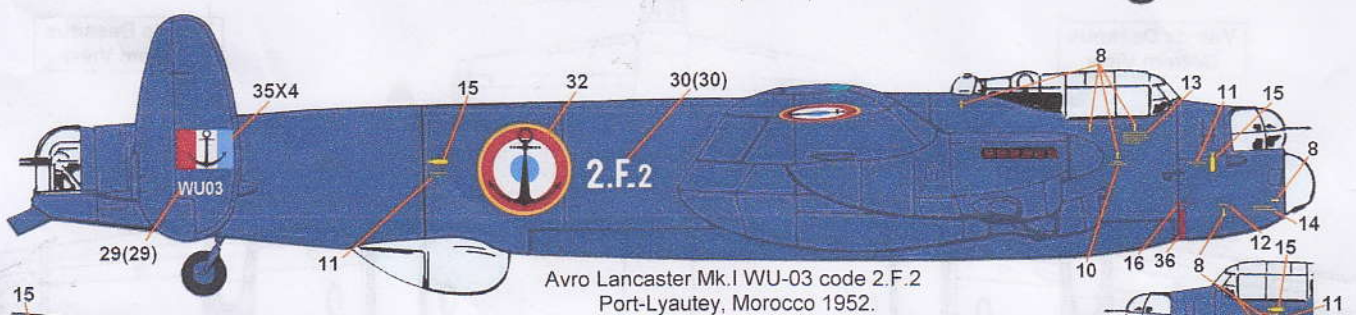

Avro Lancaster Mk.I WU-03 code 2.F.2
Port-Lyautey, Morocco 1952.

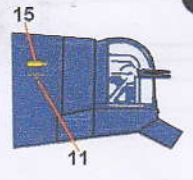

Les marquages de servitude indiqués sur le WU-03 se retrouvent sur les autres appareils bleu nuit.
Stencils indicated on WU-03 appear also on all other midnight blue aircraft.

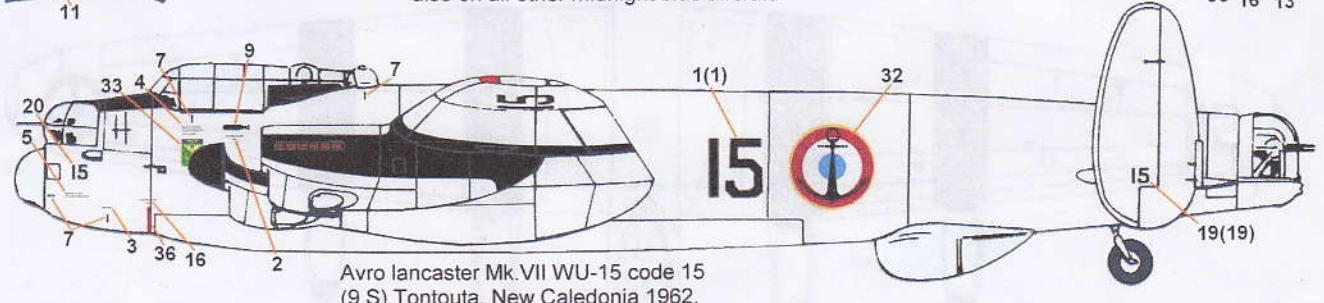
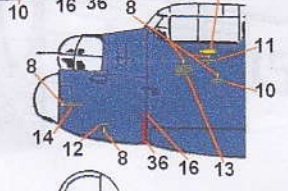

Avro Lancaster Mk.VII WU-15 code 15
(9 S) Tontouta, New Caledonia 1962.

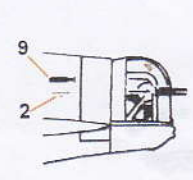
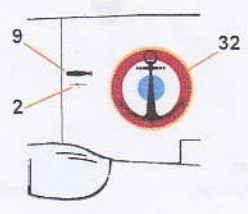
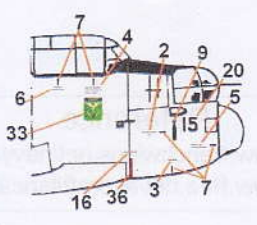

Vue de Dessus
Upper View

Vue de Dessous
Bottom View

Vue de Dessous
Bottom View

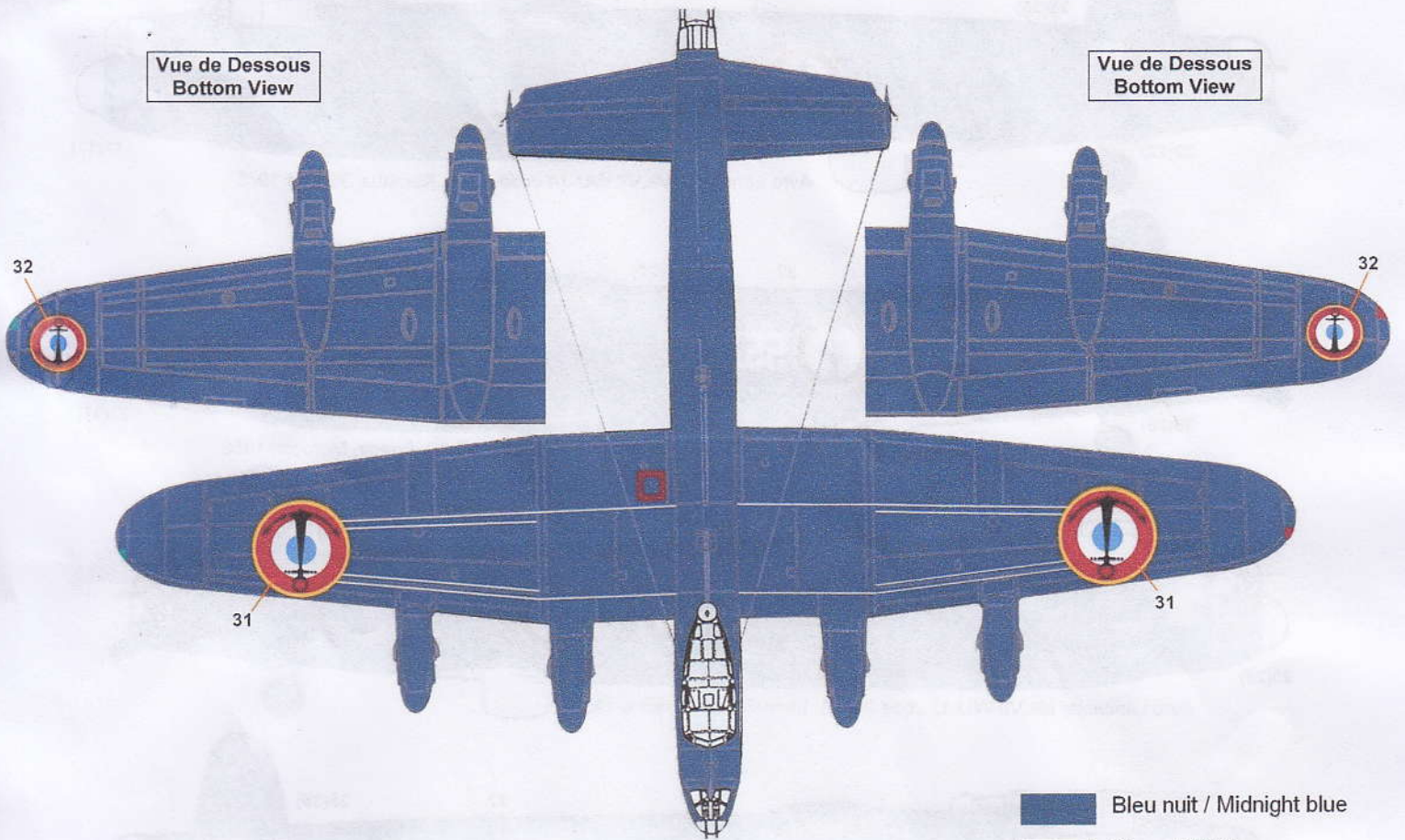

- Bleu nuit / Midnight blue
- Blanc / White
- Noir / Black

Vue de Dessus
Upper View

Vue de Dessous
Bottom View

Vue de Dessous
Bottom View

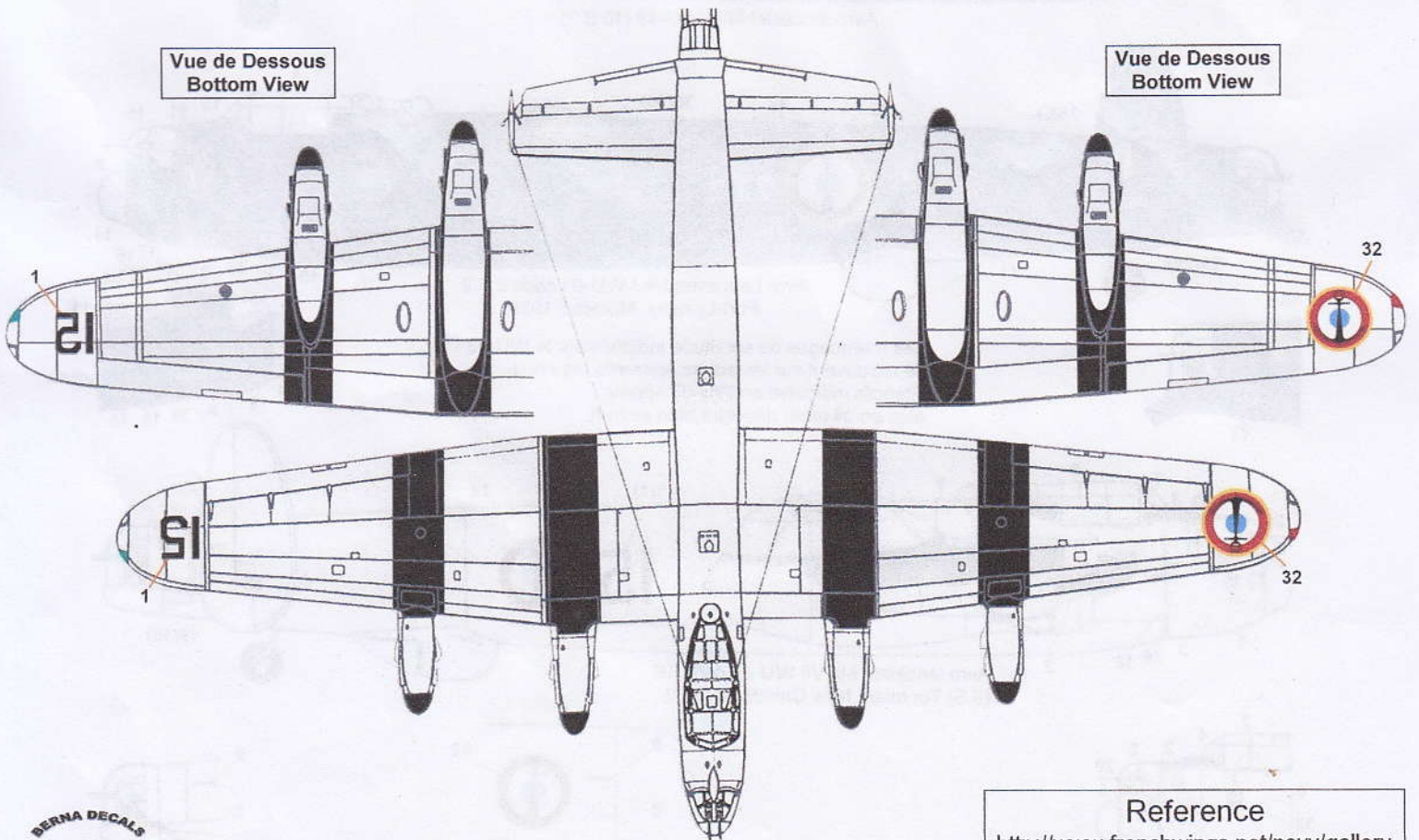

Reference
<http://www.frenchwings.net/navy/gallery>
<http://www.faa.net/aircraft/lancaster/>