

# THUNDER CALS™

Orders and info—thundercals@yahoo.com

Dealers inquiries invited

1/48th Scale P-47D Razorback Thunderbolts CBI Thundercal 48007  
Markings for five 80th FG P-47D Razorback Thunderbolts

## BURMA BANSHEES

89<sup>th</sup> FS / 90<sup>th</sup> FS / 80<sup>th</sup> FG

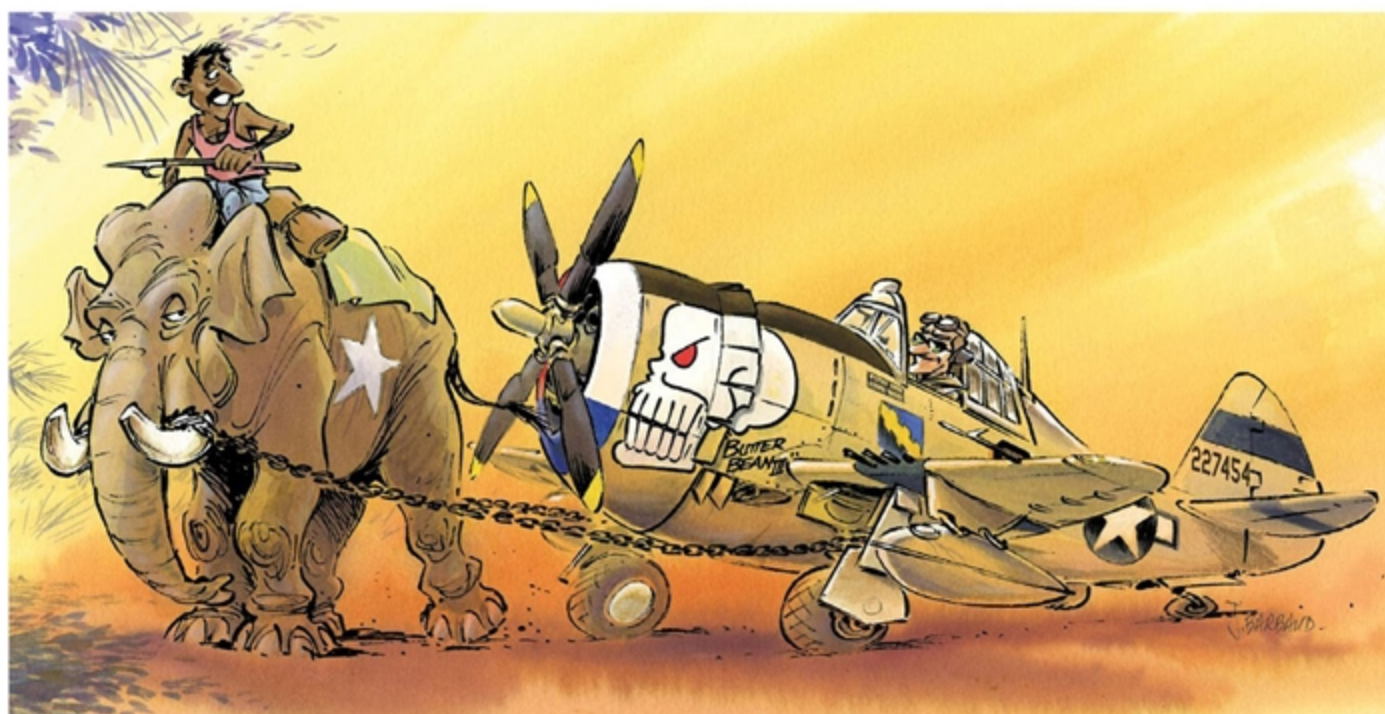

# THUNDER CALS™

Orders and info—thundercals@yahoo.com

Dealers inquiries invited

1/48th Scale P-47D Razorback Thunderbolts CBI Thundercal 48007  
Markings for five 80th FG P-47D Razorback Thunderbolts



## BURMA BANSHEES

89<sup>th</sup> FS / 90<sup>th</sup> FS / 80<sup>th</sup> FG



# THUNDER CALS™

orders and info ~ Thundercals@yahoo.com

Dealer inquiries invited



## NEW 2 decal set

Features 5 NMF razorback P47D's of the 80th FG 10<sup>th</sup> AF/ CBI / Burma Banshees

Featured P-47's:

80<sup>th</sup> FG Commander Lt Col Albert Evans Jr and Col. Sydney Grubbs featuring large "death head" skulls on either side of the cowling; Myitkyina, Burma

89<sup>th</sup> FS Frankie's Turbo/Millie LT Paul Harold Barrackpore, India  
March 1945

89<sup>th</sup> FS Miss Flash / We Dood it Again LT. Calvin H. Reasoner Jr. /Sgt. Ray F.  
Nestlehut Myitkyina, Burma late 1944

89<sup>th</sup> FS Burma Yank LT. Wharton E. Moller Myitkyina, Burma  
November 1945

BUNNY DUNNY / Lady Esther LT. Paul J. Eastman / S/Sgt. J.A. Kesti  
Tingkawk Sakan, Burma July 1944

Complete data set ~ Specified individual prop types and data for all 5 a/c ~

Separate insignia decal ~ Cartograf printed

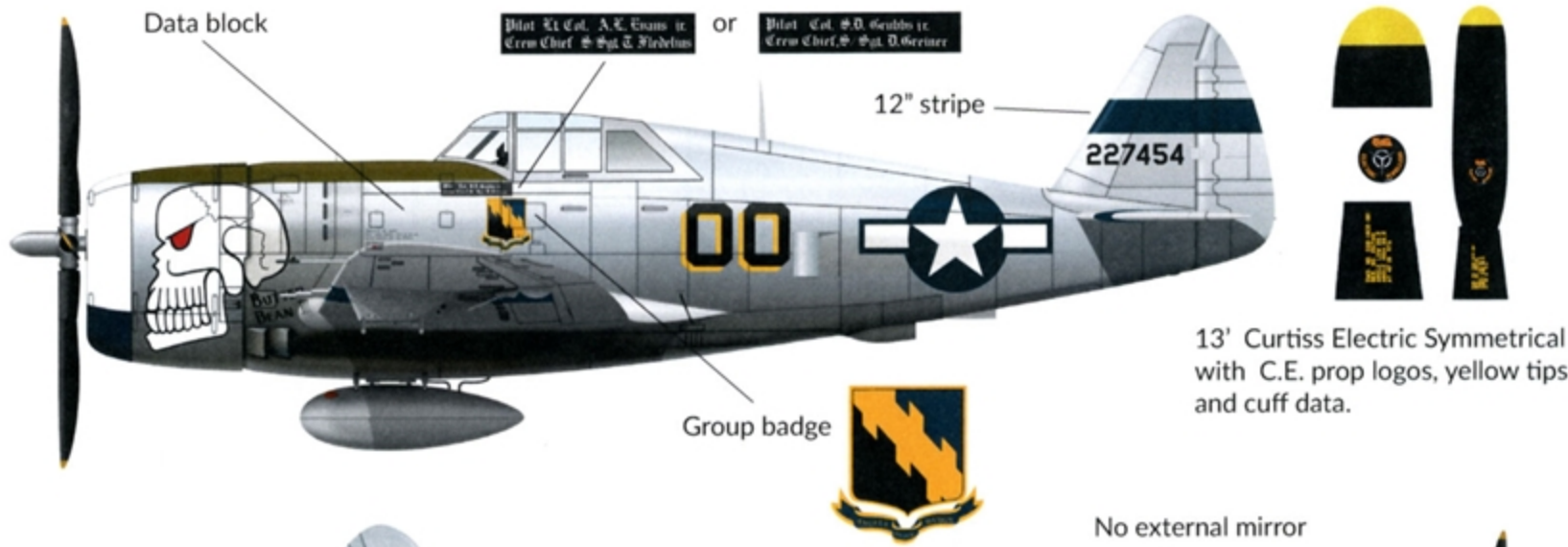

**BUTTERBEAN III**

P-47D-23-RA, 80th FG  
 LT. Col. Albert Evans Jr. June, 1944  
 Col. Sydney D. Grubbs Jr. August, 1944  
 Myitkyina, Burma



Paint cowl in three segments of medium red, medium dark blue and white.

Reference for Skull decal placement

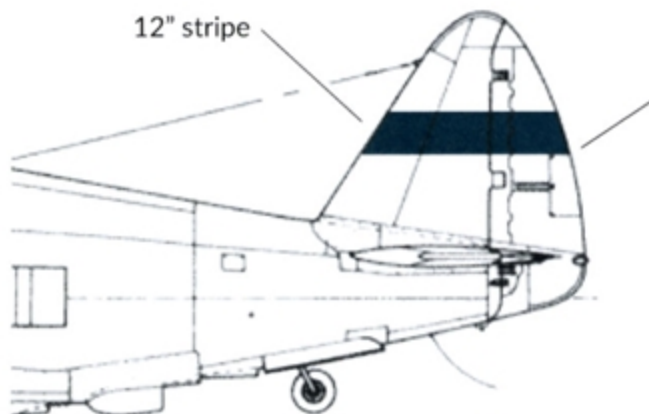
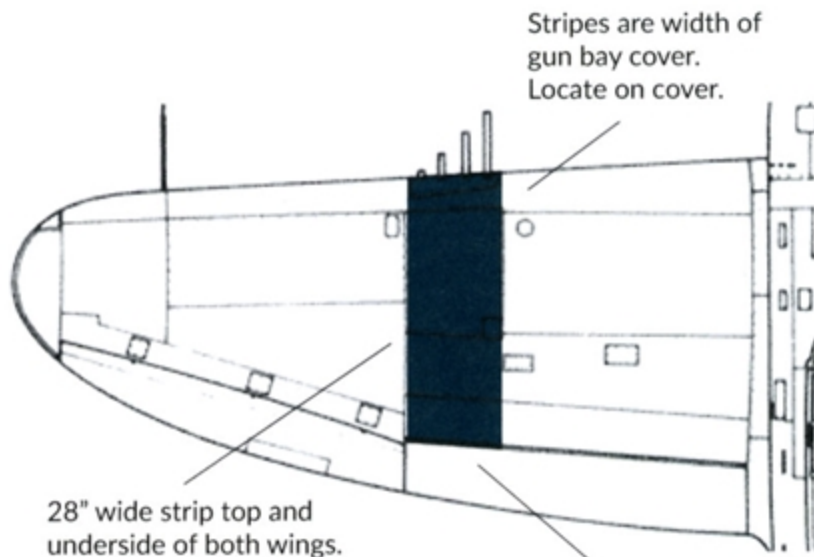

Location key:  
 Bottom of stripe, slightly on trim tab.

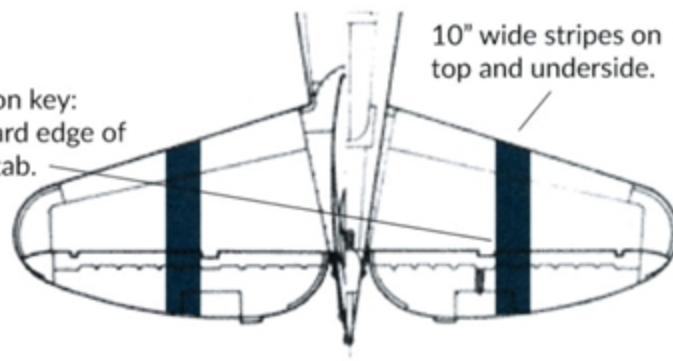

Location key:  
 outboard edge of hinge tab.

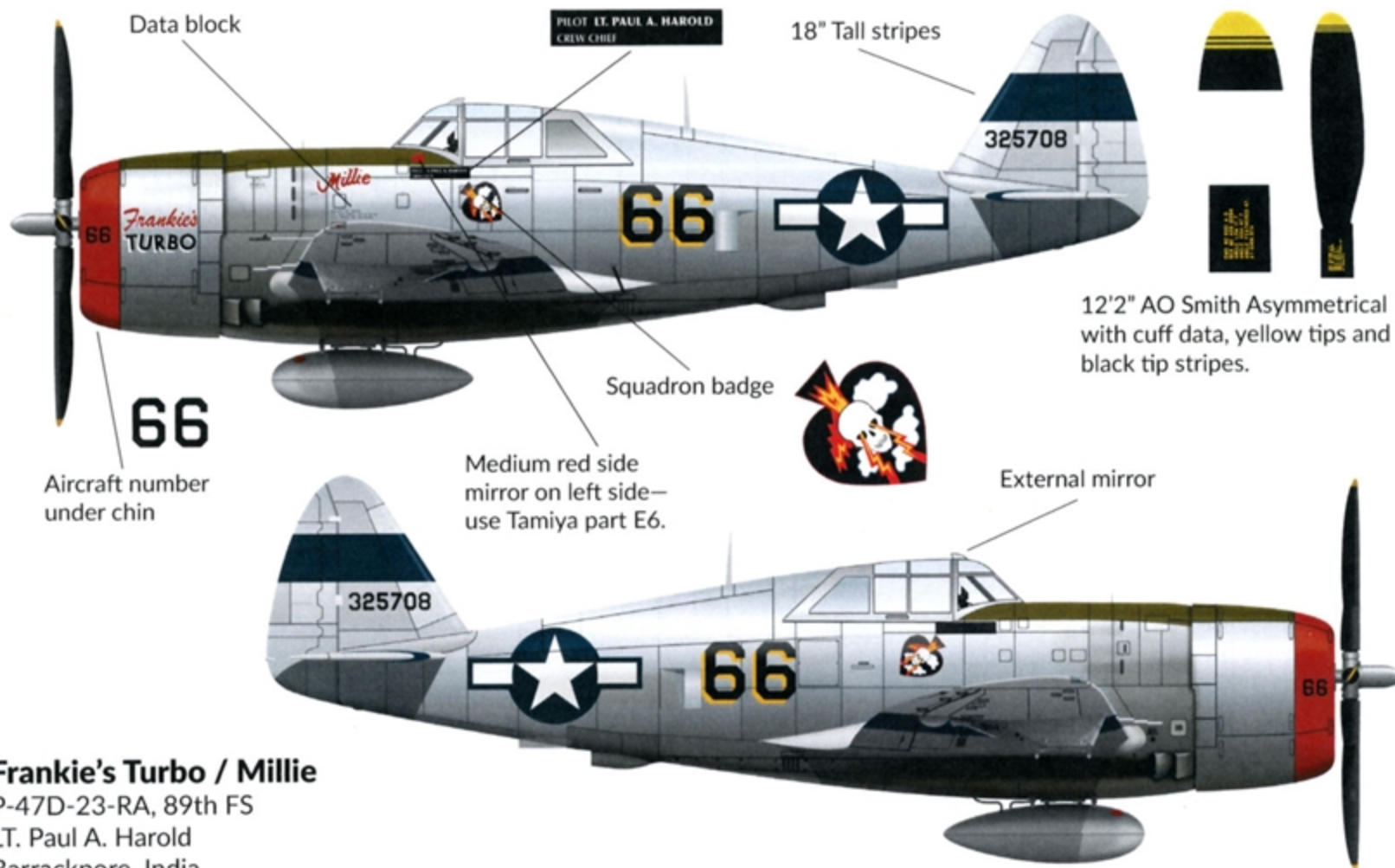

**Frankie's Turbo / Millie**

P-47D-23-RA, 89th FS  
 LT. Paul A. Harold  
 Barrackpore, India  
 March 1945

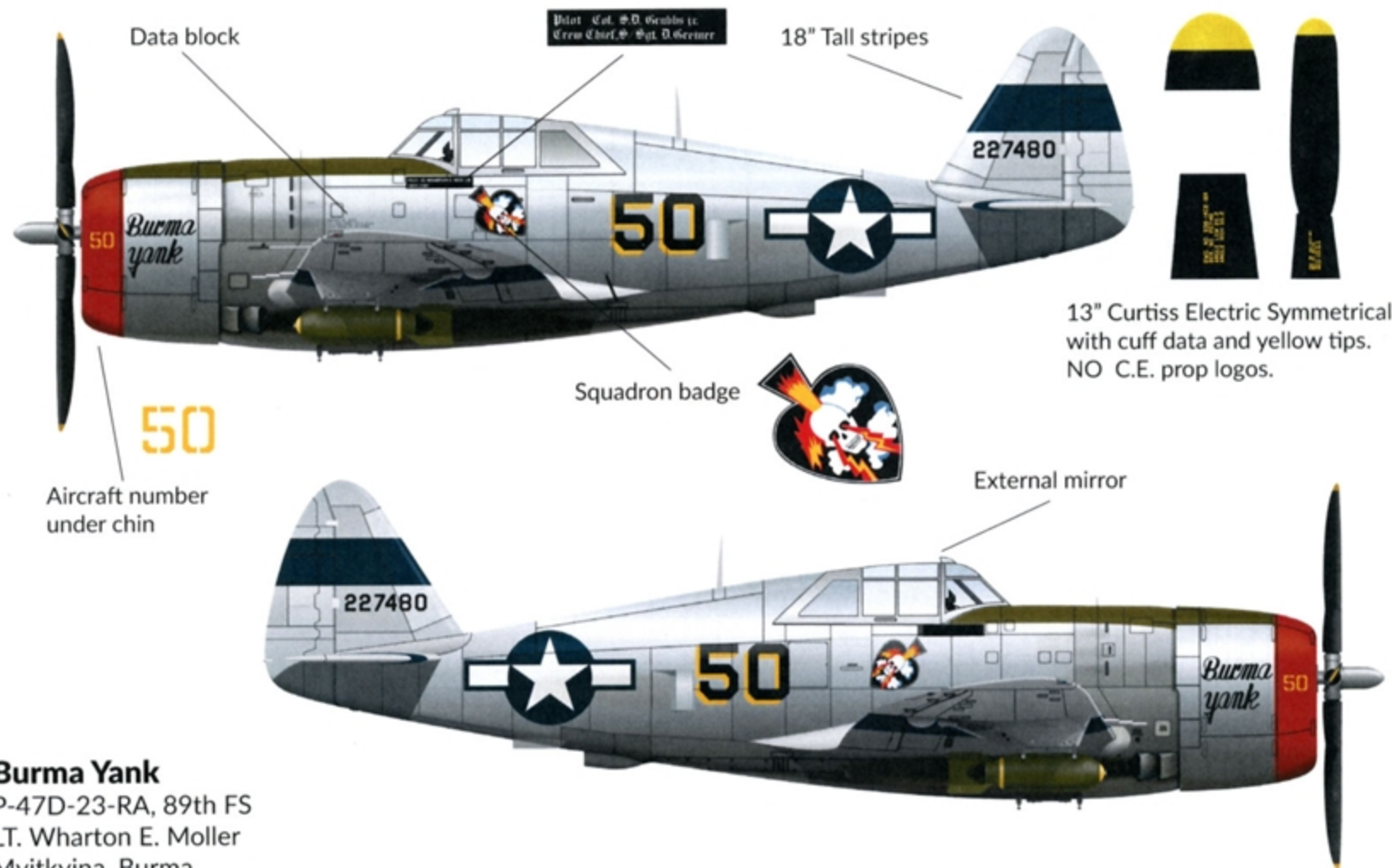

**Burma Yank**

P-47D-23-RA, 89th FS  
 LT. Wharton E. Moller  
 Myitkyina, Burma  
 November 1945

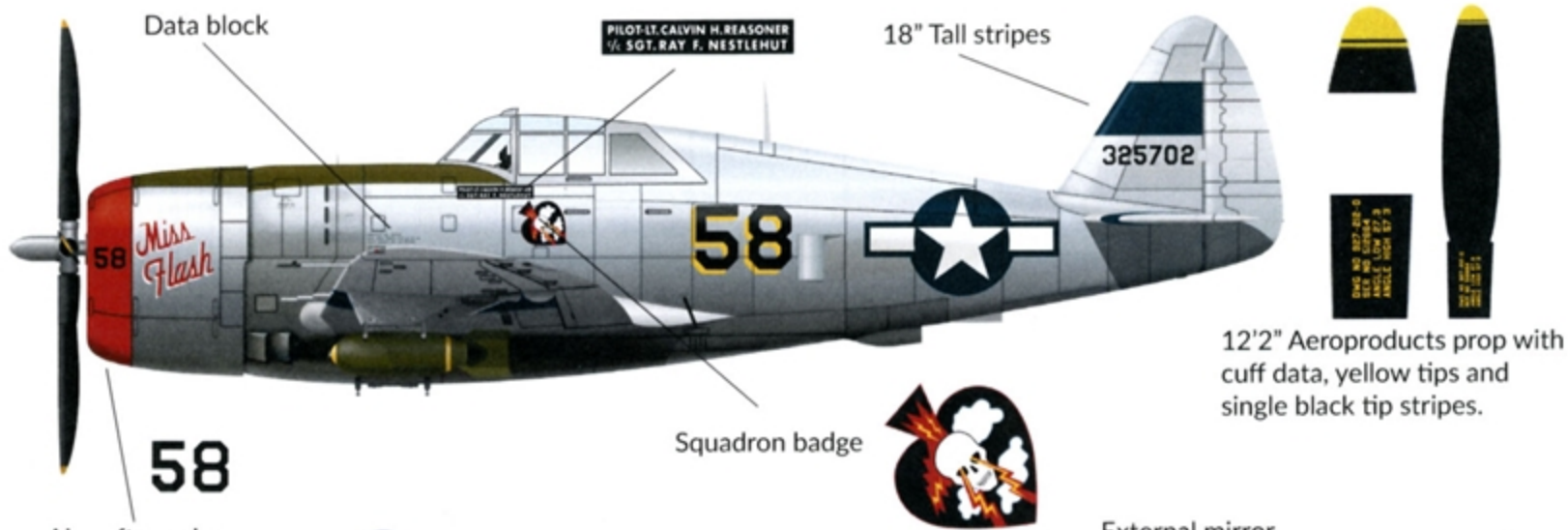

**58**  
Aircraft number under chin

**Miss Flash/We Dood it Again**

P-47D-23-RA, 89th FS  
LT. Calvin H. Reasoner Jr  
Sgt. Ray F. Nestlehut  
Myitkyina, Burma late 1944

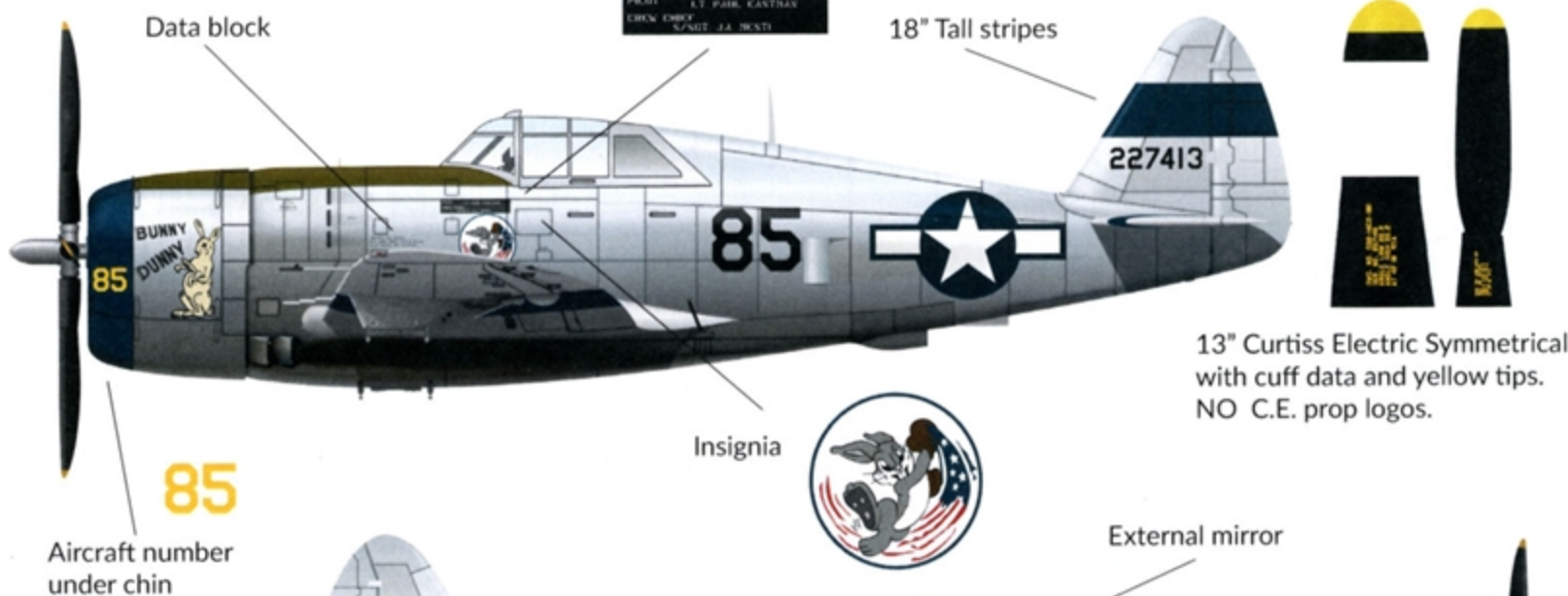

**85**  
Aircraft number under chin

**BUNNY DUNNY / Lady Esther**

P-47D-23-RA 90th FS  
LT. Paul J. Eastman  
S/Sgt. J.A. Kesti  
Tingkawk Sakan, Burma July, 1944



Medium dark blue  
Cowl ring

STANDARD EAC STRIPE PLACEMENT, 80th FG

28" wide stripes top and underside of both wings.

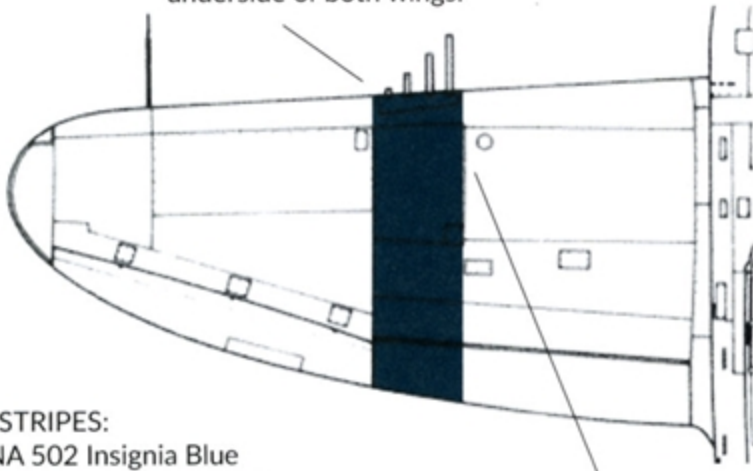

Stripes are width of gun bay cover. Locate on cover.

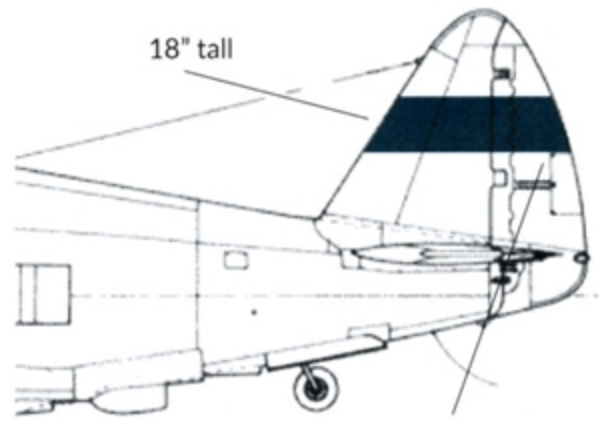

18" tall

Location key: bottom of stripe, slightly on trim tab.

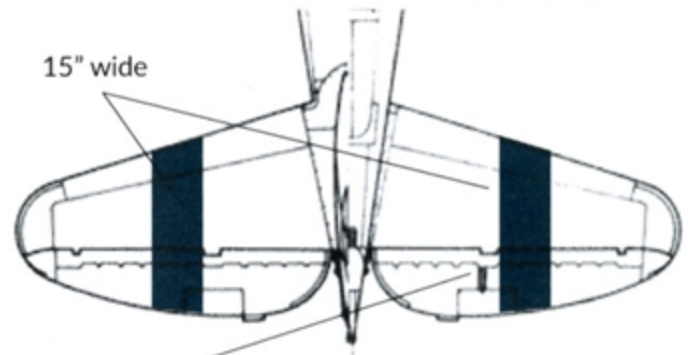

15" wide

Location key: outboard edge of hinge tab.

EAC STRIPES:

- ANA 502 Insignia Blue
- Wings 28" wide (Type B)
- Vertical 18" tall
- Stabilizers 15" wide

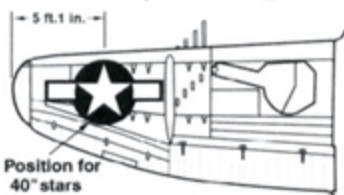
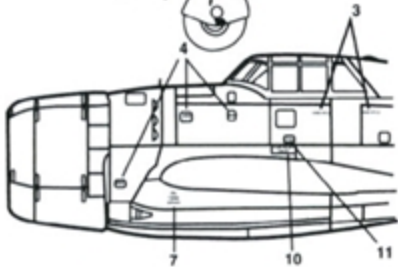
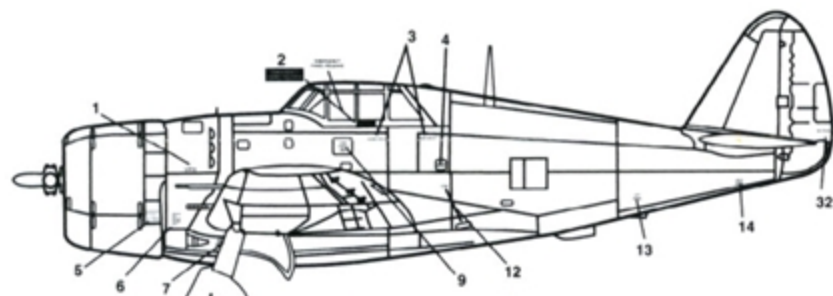

Position for 40" stars

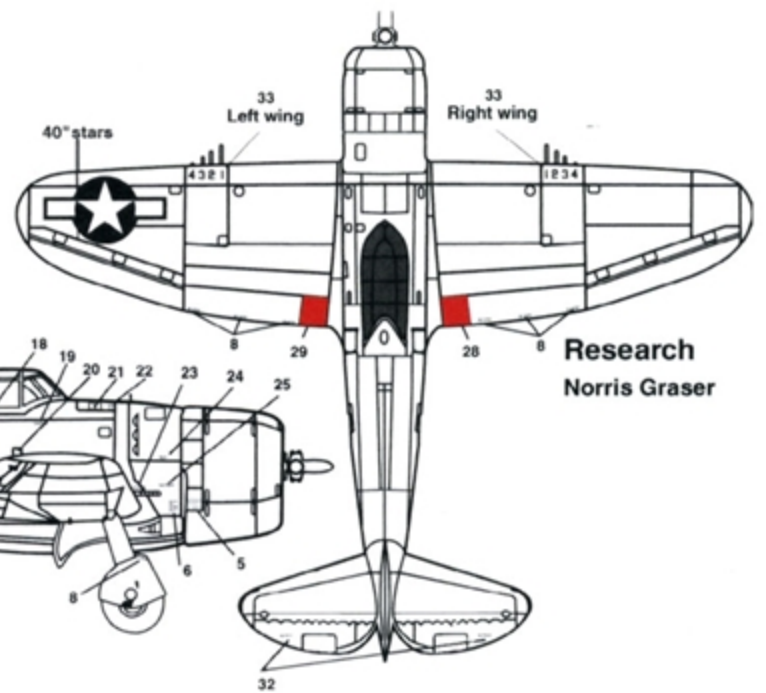
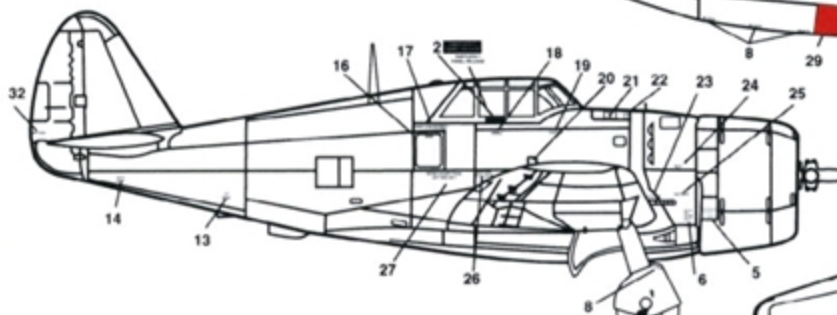

Research  
Norris Graser



Flap Indicator  
Left & Right

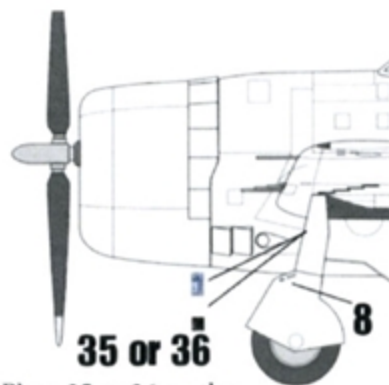

Place 35 or 36 on the front side of the landing gear strut assembly.

COLORS:

- ANA 502 Insignia blue
- NMF
- Medium red
- White
- Olive drab
- Medium dark blue

Decals are sized to the Tamiya P-47D Razorback, but are suitable for the Hasegawa, Otaki and Revell/Monogram 1/48th scale razorback.

## **References & History**

Battle Colors Vol. VI Insignia and aircraft Markings

CBI & Western Pacific, Robert A. Watkins, Schiffer Military History, 2017

Rough War: The Combat Story of Lt. Paul J. Eastman, a Burma Banshee P-40 and P-47 Pilot, Walt Shiel, Slipdown Mountain Pub. LLC, 2011 (Bunny Dunny)

Thunderbolt the Republic P-47 Thunderbolt in the Pacific Theater, Ernest R. McDowell, Squadron/Signal Pub., 1999

Air Force Colors Vol. 3 Pacific and Home Front 1942-47, Dana Bell, Squadron/Signal, Pub., 1997

Tenth Air Force Story, Kenn C. Rust, Historical Aviation Album Pub., 1980

## **Additional References**

[www.burmabanshees.com/](http://www.burmabanshees.com/)

Flight Journal article Burma Banshees 90tgh FS in the CBI, Gregory Pons  
Downloadable PDF:

<https://www.flightjournal.com/wp-content/uploads/2018/12/4Burma-Banshees.pdf>

Research Norris Graser

## **Thanks**

Jean Barbaud—Cover art and research

Don Barnes—Decal and instruction art

Robert Jones II—Grandnephew of LT. Calvin Reasoner / Miss Flash

Ed Mate—Critical modeler at large

## **Contact Us**

Email: [thundercals@yahoo.com](mailto:thundercals@yahoo.com)

Website: [thundercals.com](http://thundercals.com)

Facebook: [facebook.com/Thundercals](https://facebook.com/Thundercals)

## **Also Available From Thundercals**

48001 P-47D Razorback Thunderbolts PTO Pt 1; 58th FG, 318th FG

48002 P-47D Razorback Thunderbolts PTO Pt 2; 318th FG, 348th FG

48003 P-47D Razorback Thunderbolts PTO Pt3; 58th FG

48004 P-47D Razorback Thunderbolts PTO Pt 4; 318th FG

48005 P-47 Thunderbolt National Insignia Type 4 – Data Decals Pt 1

48006 P-47D Bubbletop/Razorback Thunderbolts ETO Pt1; 78th FG/8th Air Force; 365th FG/9th Air Force

[thundercals.com](http://thundercals.com)