

1**2****3**

4

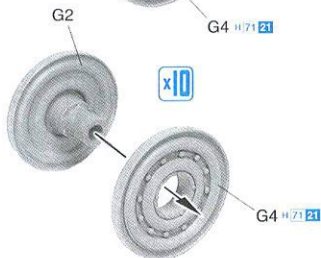

5

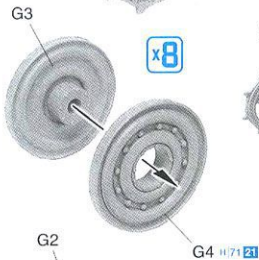
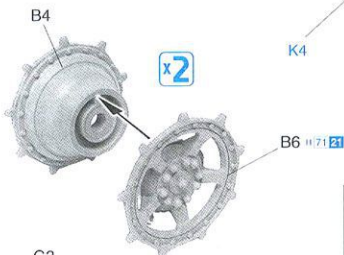
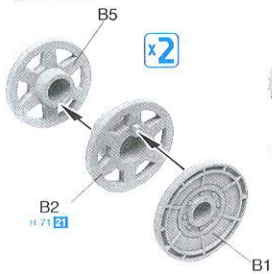
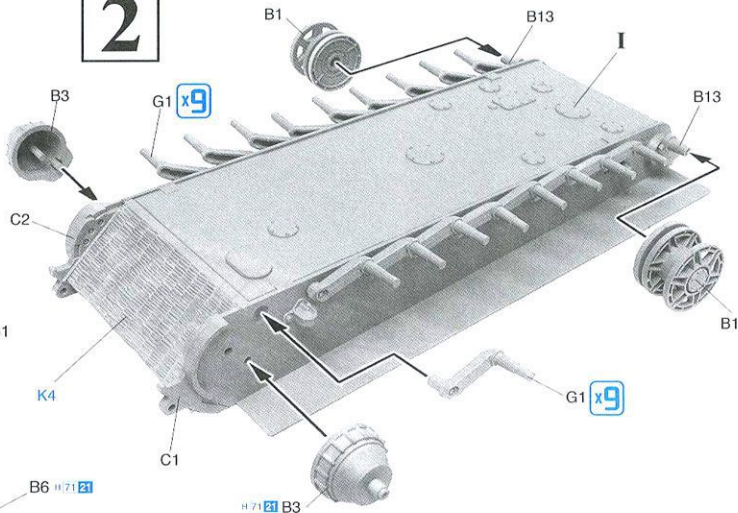
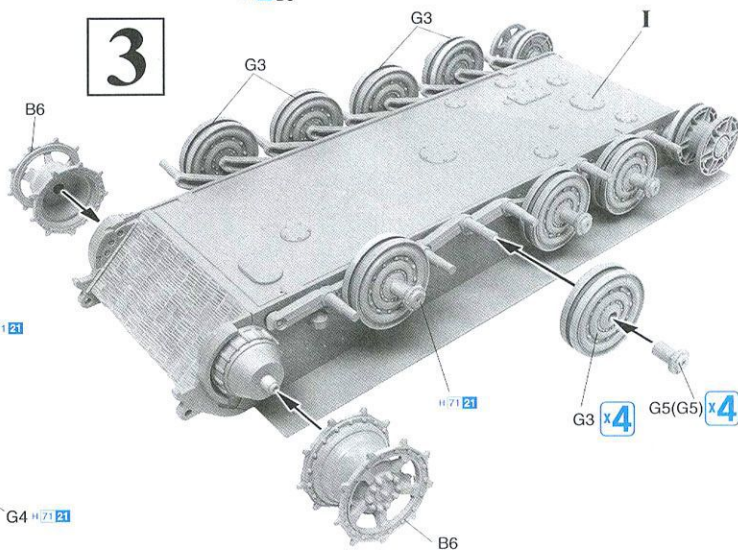
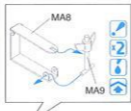
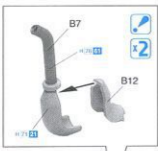
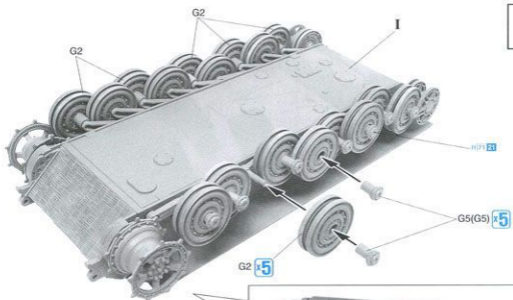
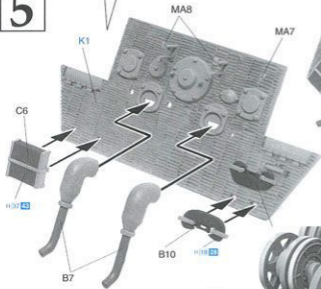

6

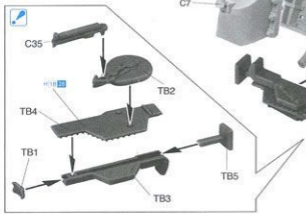
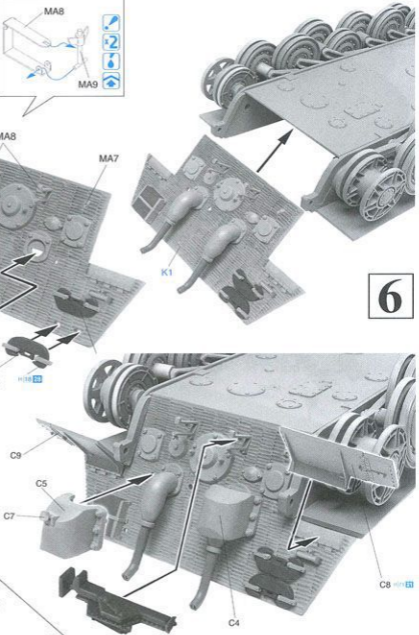

7

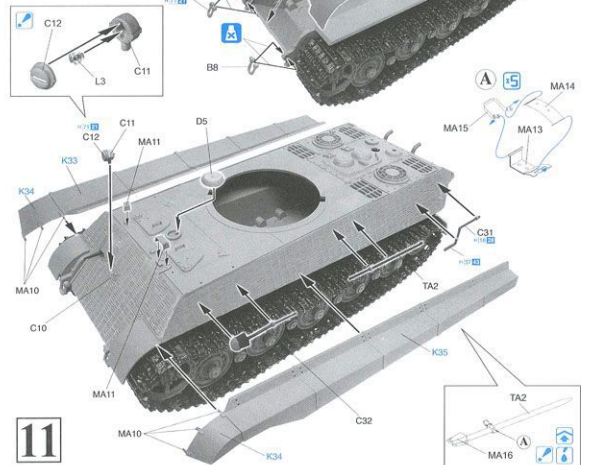
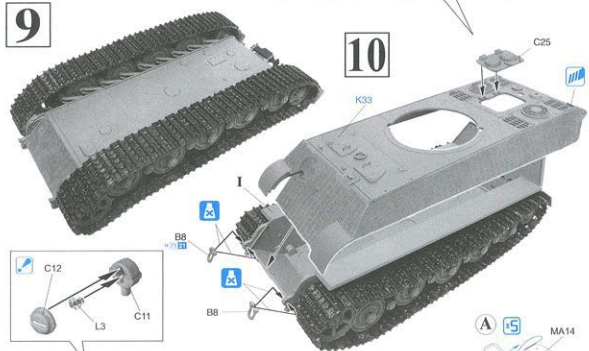
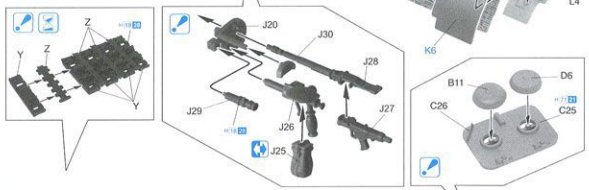
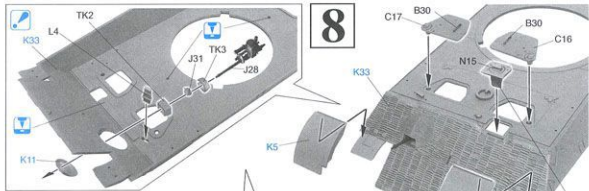

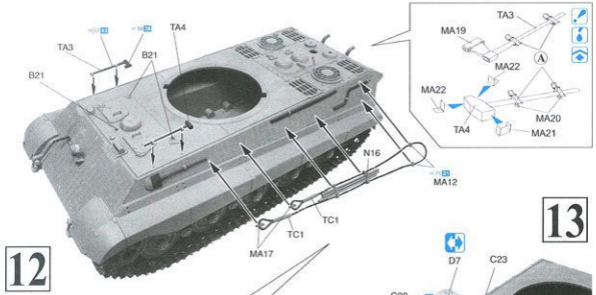

13

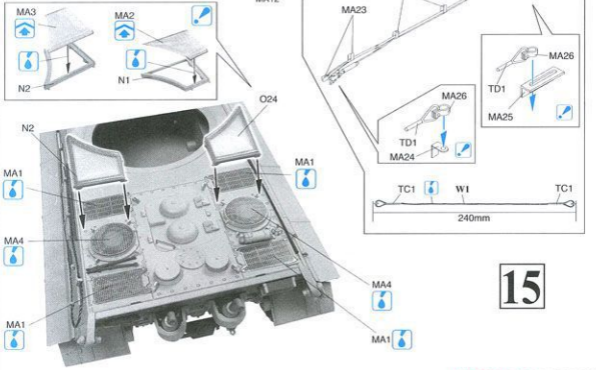
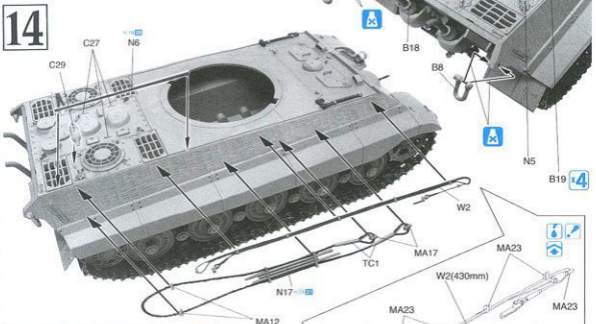
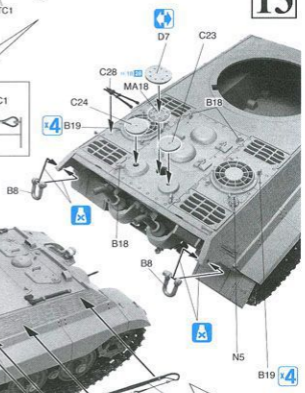

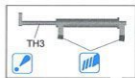
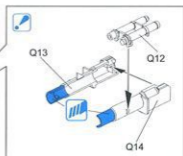
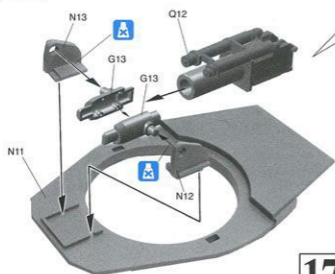
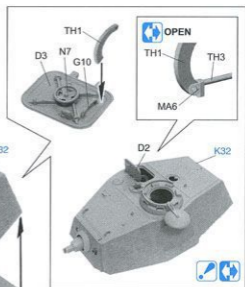
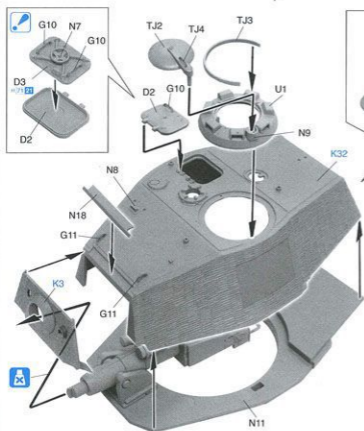
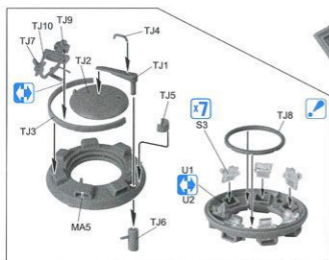
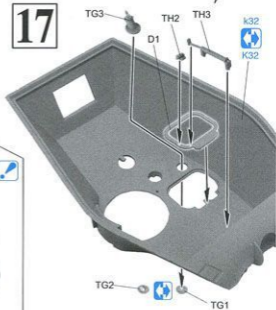
16**17****18**

19

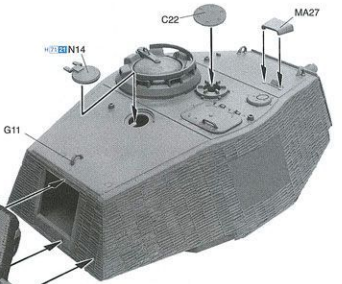

20

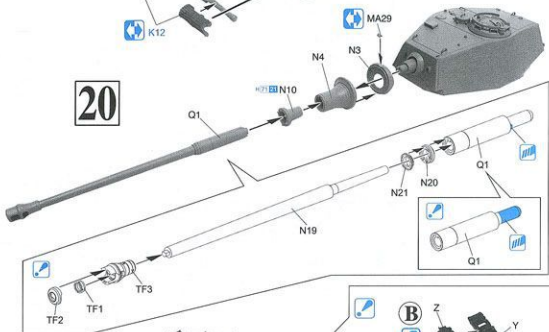

21

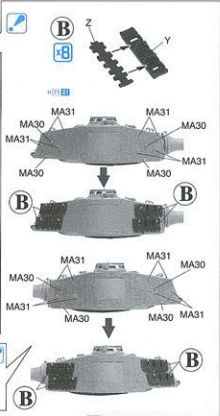

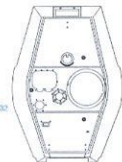
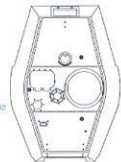
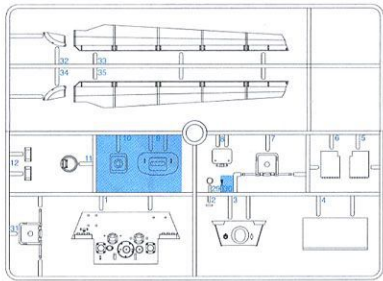
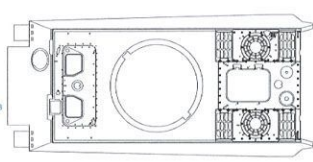
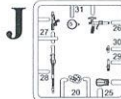
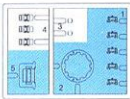
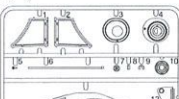
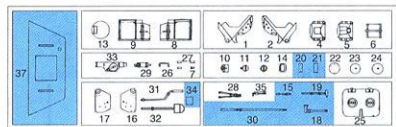
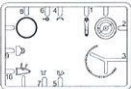
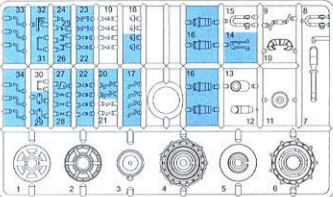
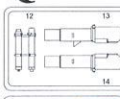
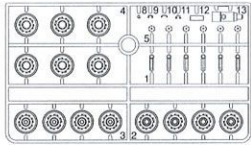
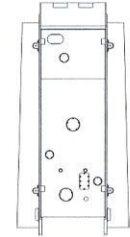
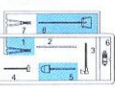
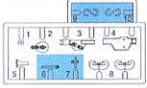
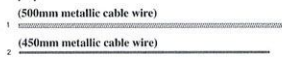
k**K****K****L****N****C****TF****TJ****Bx2****Q****TG****Gx3****I****TA****TB****S****U****W**

MagiTrack
 PATENT REGISTERED
 実用新案登録済み

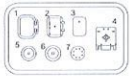
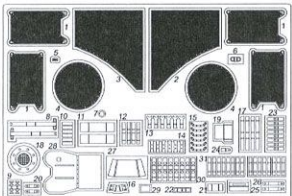
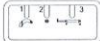
D**TK****MA** (Photo-etched Parts)**Yx6****Zx6****TC****TD****TH**

この部品は使用しません
 Parts not for use.
 Teile werden nicht verwendet.
 Pièces a ne pas utiliser.
 Parti nin ulizzati.
 不需要的零件

Paint & Markings

マーキング及び塗装図

Markierungen und Bemalung

Decoration et Peinture

Marchio & Pittura

標貼及着色指示

2/s.Pz.Abt.505, Russia 1944

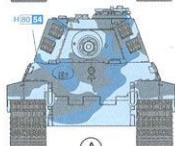
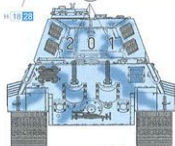
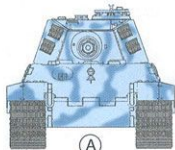
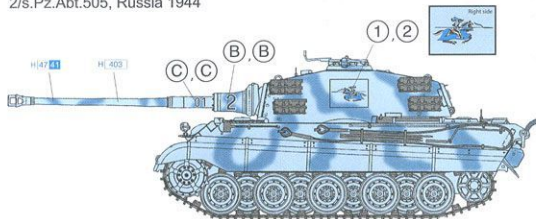

1/s.Pz.Abt.505, Poland 1944

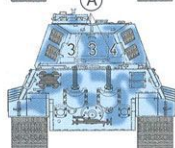
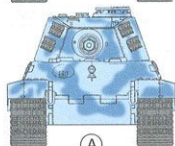
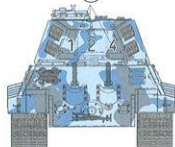
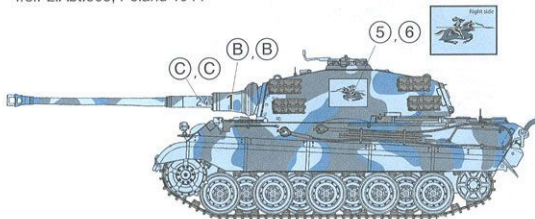

3/s.Pz.Abt.505, Trakehnen 1944

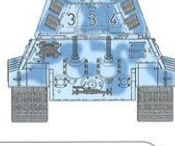
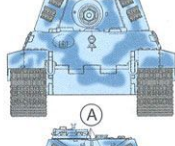
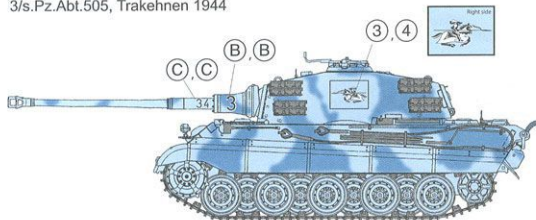

s.Pz.Abt.505



1.Kompanie

100	101		
111	112	113	114
121	122	123	124
131	132	133	134

2.Kompanie

200	201		
211	212	213	214
221	222	223	224
231	232	233	234

3.Kompanie

300	301		
311	312	313	314
321	322	323	324
331	332	333	334

H 1 1	ホワイト	1745	WHITE	WEISS	BLANC	BIANCO	白色
H 8 8	シルバー	1546	SILVER	SILBER	ARGENT	ARGENTO	銀色
H 10 10	カッパー	1551	COPPER	KUPFER	CUIVRE	RAME	銅色
H 12 33	つや消しブラック	1749	FLAT BLACK	MATTSCHWARZ	NOIR MAT	NERO OPACO	啞黒色
H 18 28	黒鉄色	1415	STEEL	STAHL	ACIER	ACCIAIO	黒銀色
H 37 43	ウッドブラウン	1735	WOOD BROWN	HOLZBRAUN	BRUN BOIS	MARRONE LEGNO	木棕色
H 47 41	オリーブブラウン	1533	RED BROWN	ROT BRAUN	MARRON ROUGE	MARRONE ROSSICCIO	紅褐色, 啡紅色
H 66 19	RLMサンディブラウン79	1706	RLM SANDY BROWN 79	RLM SAND GELB 79	RLM BRUN SABLE 79	SABBIA RLM 79	RLM砂褐色79
H 71 21	ミドルストーン	1742	MIDDLE STONE	STEINGRAU, MITTEL	PIERRE MOYEN	NOCCILOLO MEDIO	中石色
H 76 61	焼鉄色	1406	BURNT IRON	GEBR, EISEN	FER BRULÉ	FERRO BRUCIATO	焼鉄色
H 80 54	カーキグリーン	1710	KHAKI GREEN	KHAKIGRÜN	VERT KHAKI	VERDE KAKI	砵磯綠色
H 303 303	グリーン FS34102	1712	GREEN	GRÜN	VERT	VERDE	 HOBBY 綠綠CH