

Zestaw Kalkomanii Decals

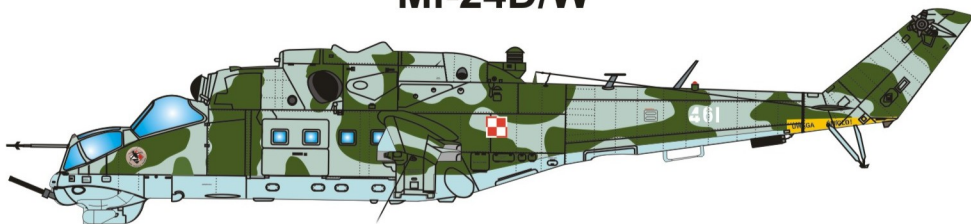

Mi-24D/W



Mi-24D, Polish Army „461”, Iraq, Operation Iraqi Freedom , Ad Diwaniyah 2007



Mi-24D, Polish AF „015”, Training Center of Engineering and Aviation, Oleśnica 2001

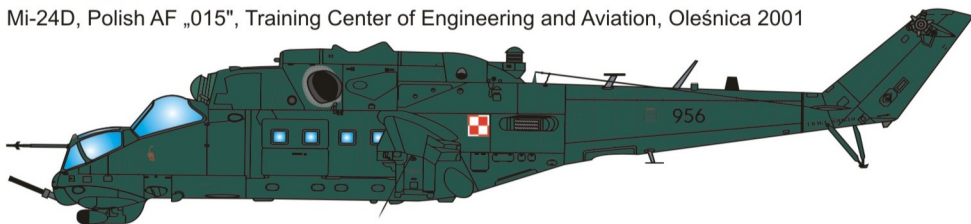

Mi-24W, Polish Army „956”, ISAF Ghazni 2013

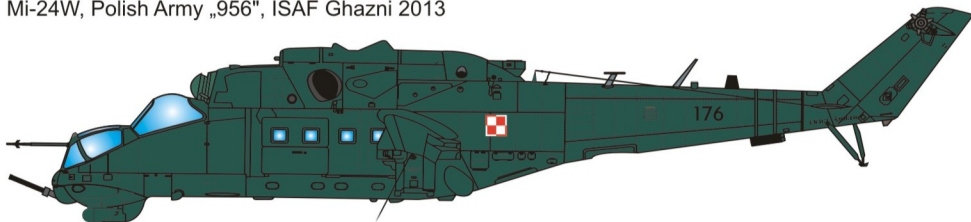

Mi-24D, Polish Army „176”, 49th Air Base 2012

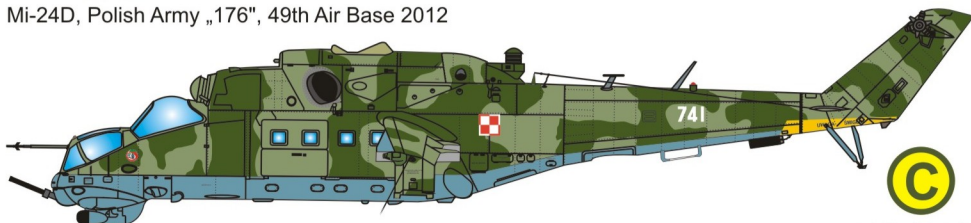

Mi-24W, Polish Army „741”, 56th Combat Helicopters Regiment , Inowrocław 2002



72154

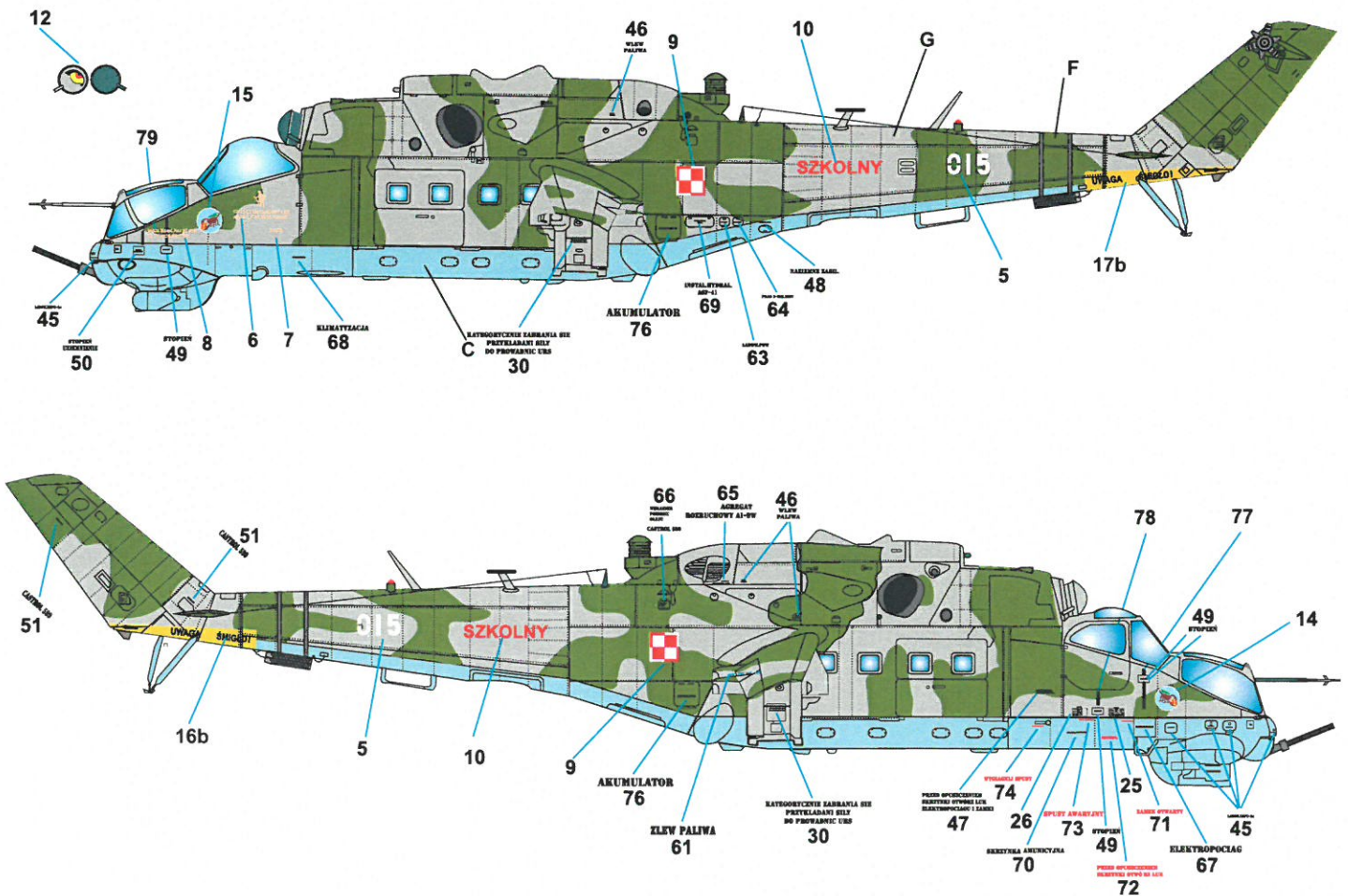
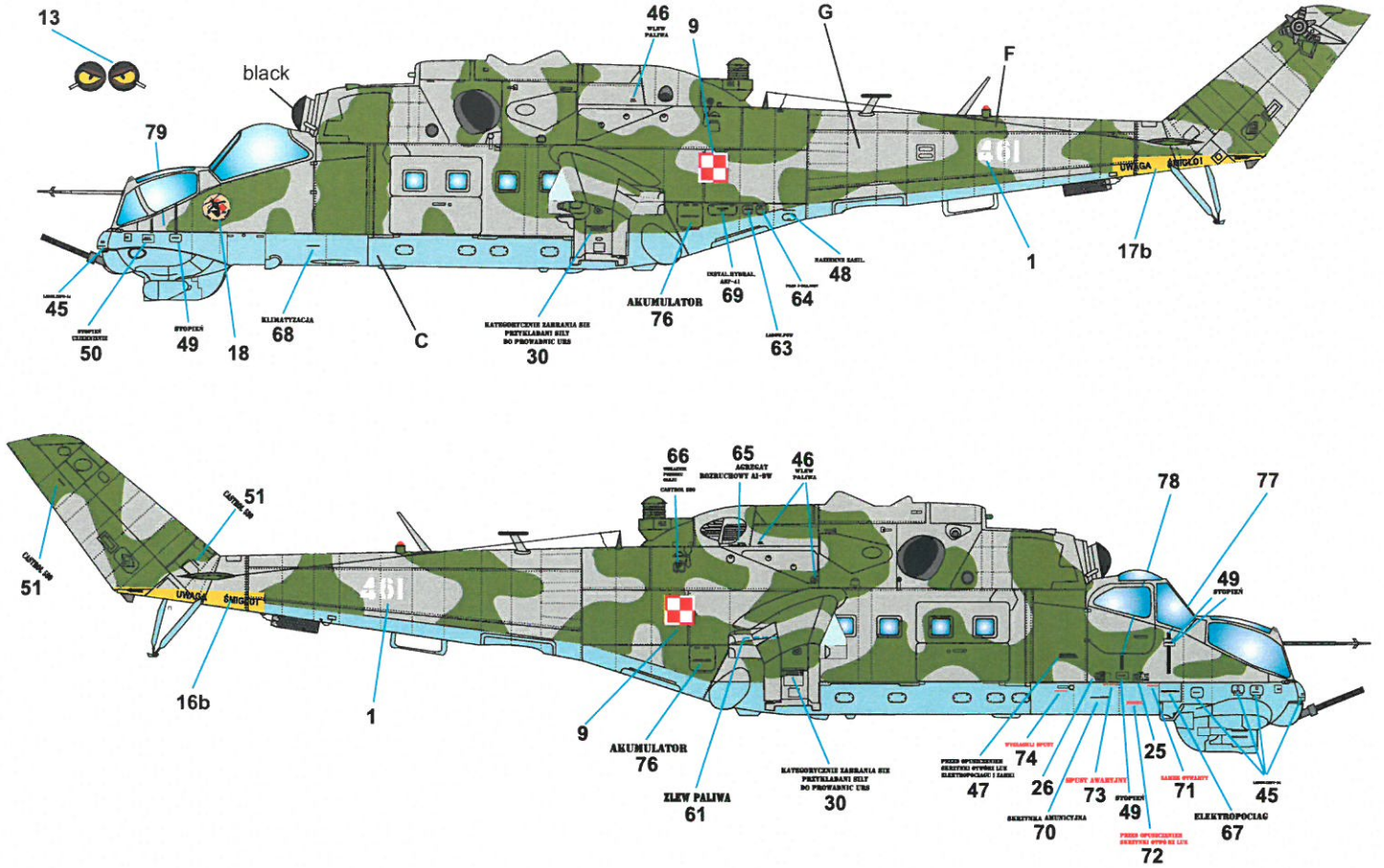

Mi-24W, Polish Army „956”, ISAF Ghazni 2013

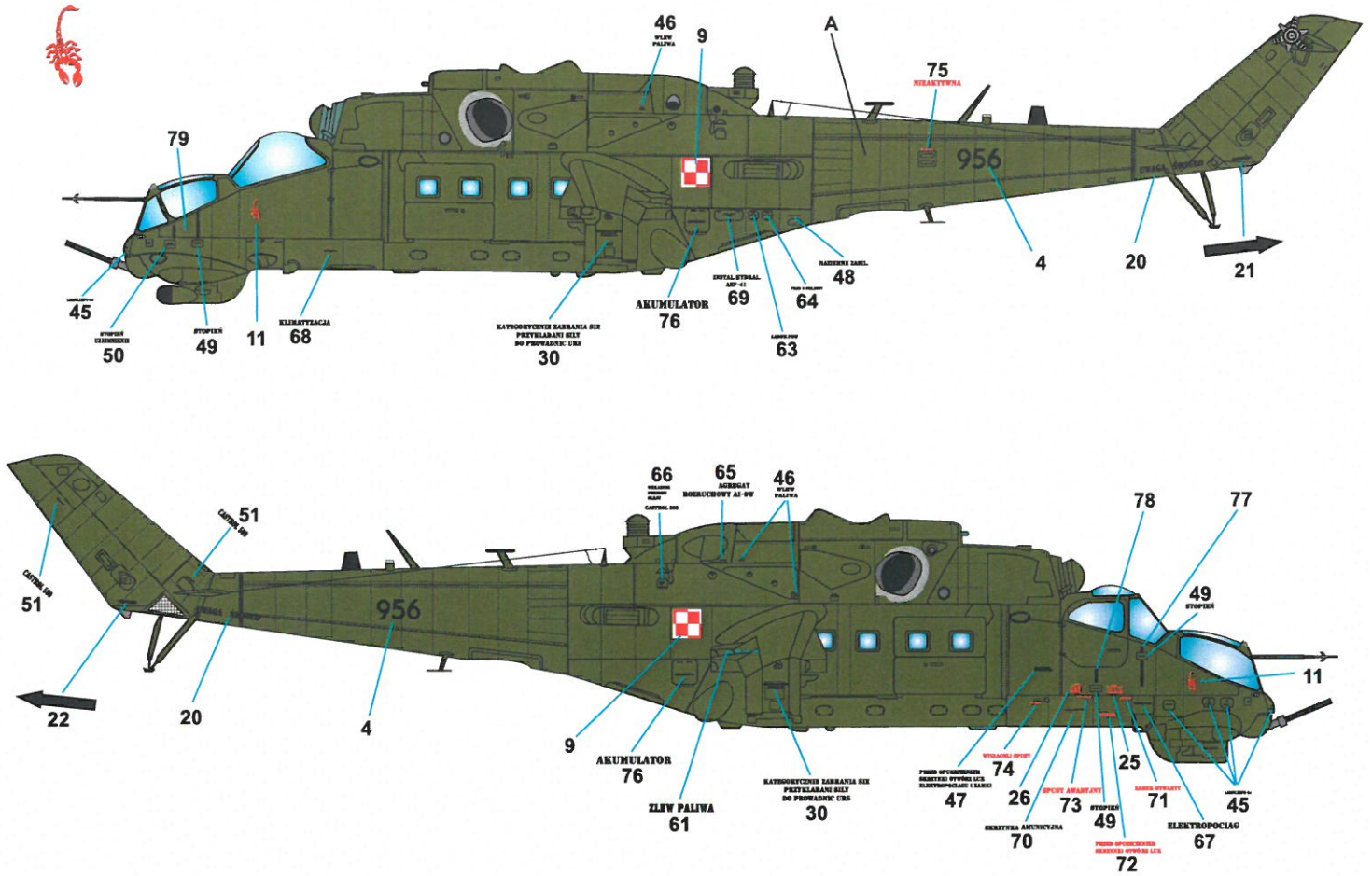

Mi-24D, Polish Army „176”, 49th Air Base 2012

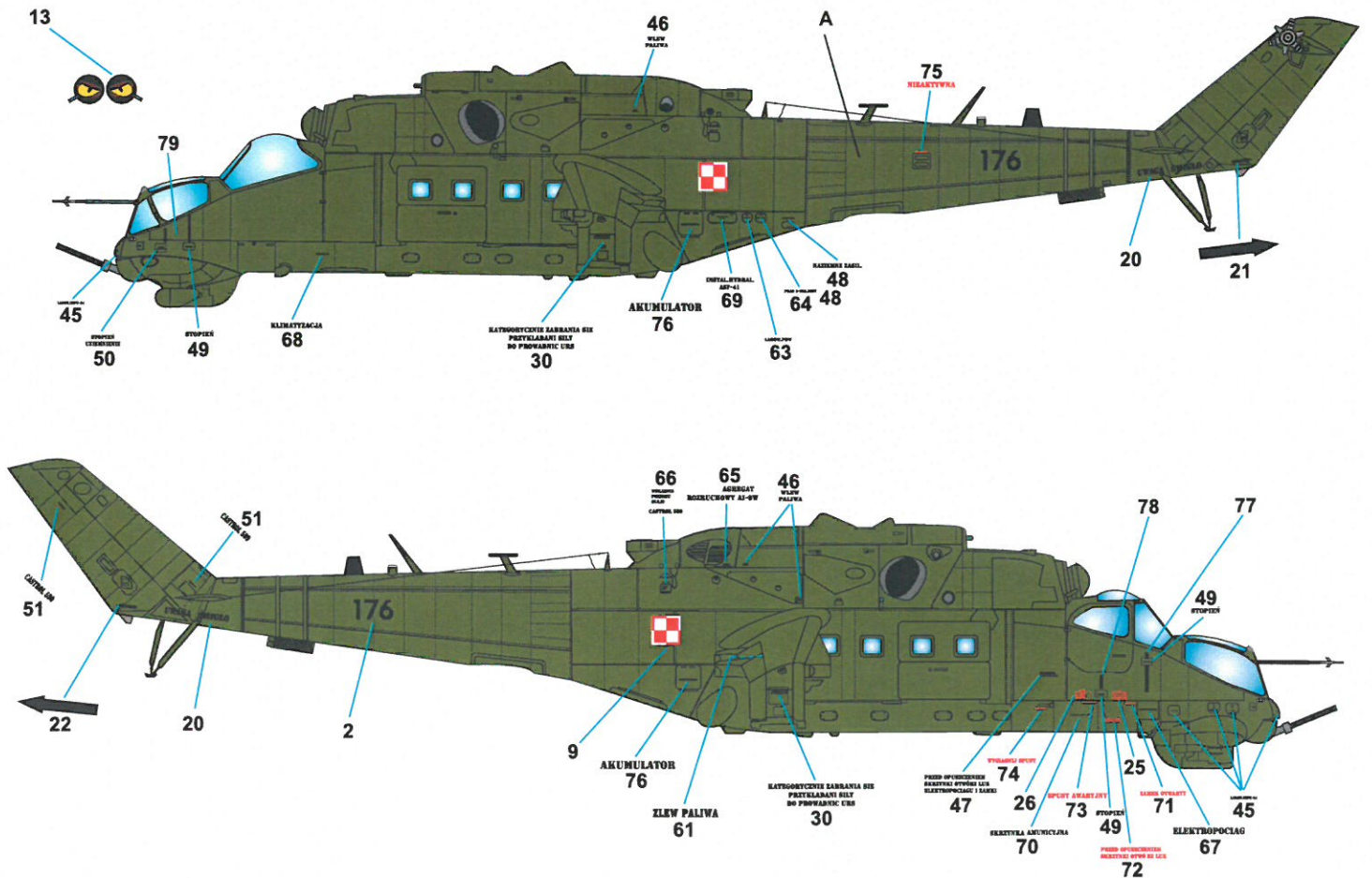

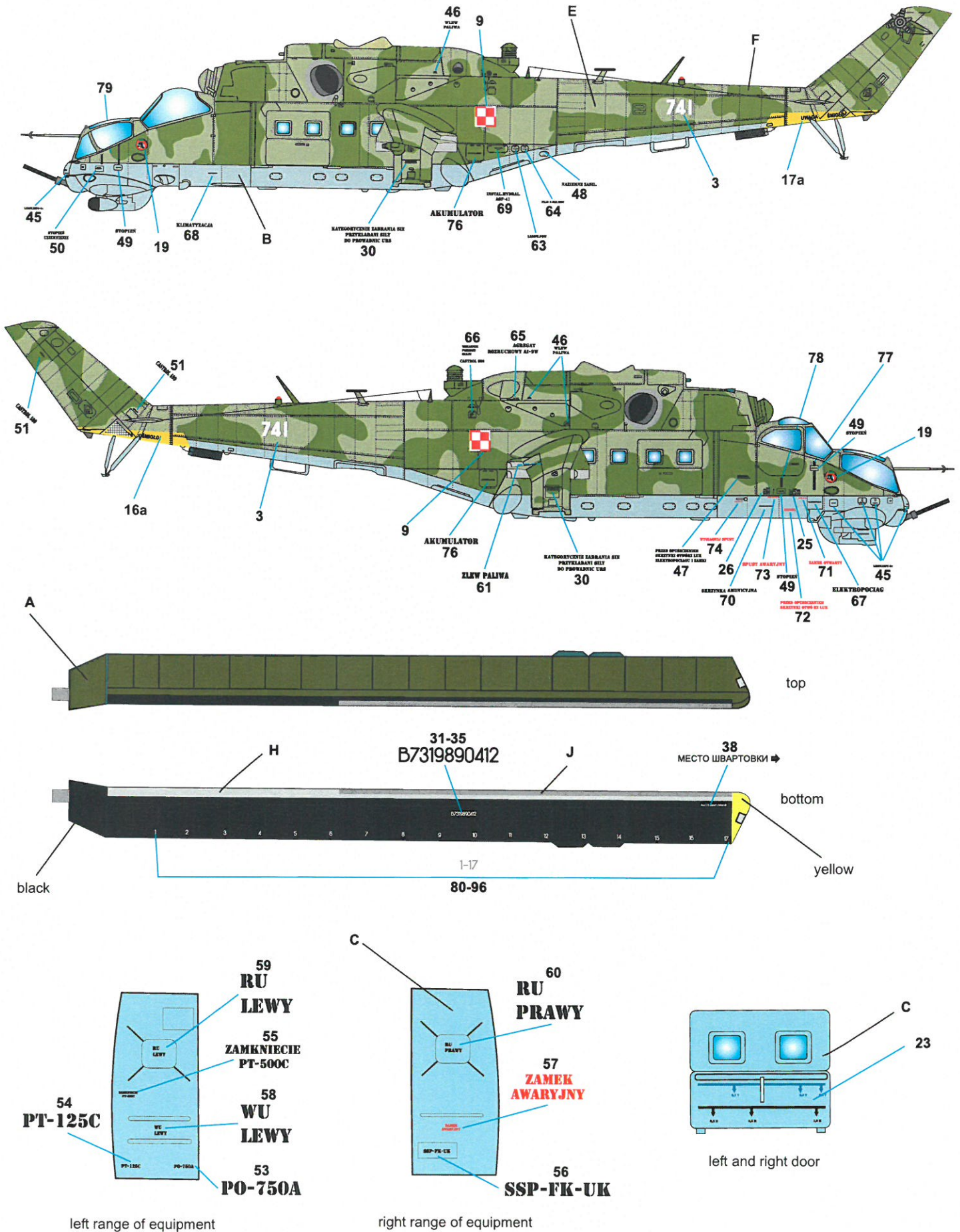

Designed by Adam Pękala

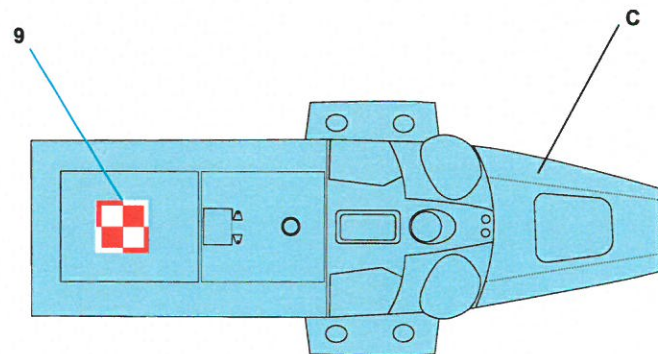
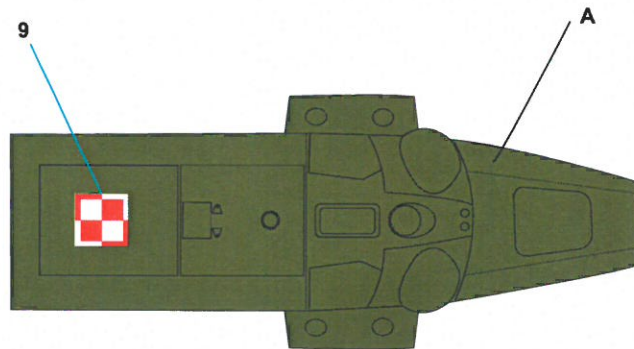
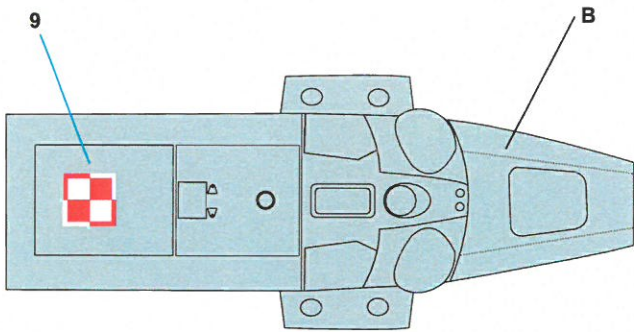

tail rotor also for all versions

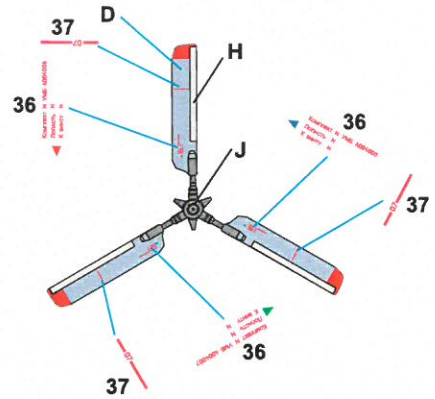

variants:

52 CASTROL

white lettering on Castroln 599
oil tank engine TW3-117
- only option open guards in the model

43-44 NIE STAWAĆ NIE STAWAĆ

red warning labels on engine casings TW3-117,
WR-24 gearbox and engine casings boot AI-9
- only option open guards in the model



Mi-24D, Polish AF „461”,
49th Combat Helicopters Regiment,
Pruszcz Gdański 1992

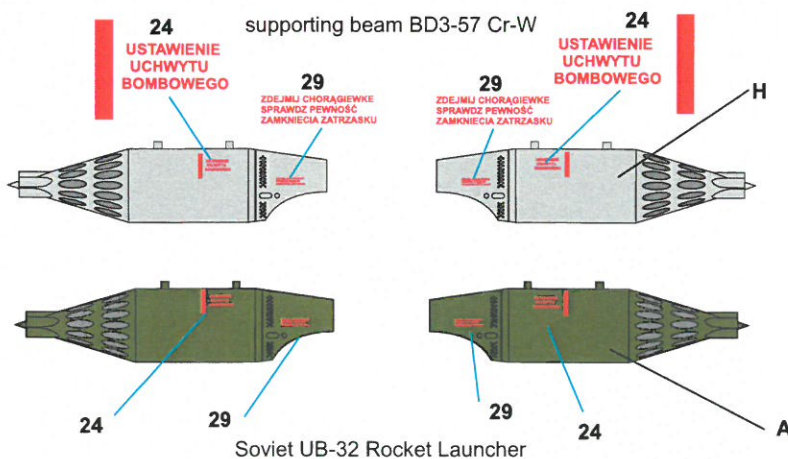
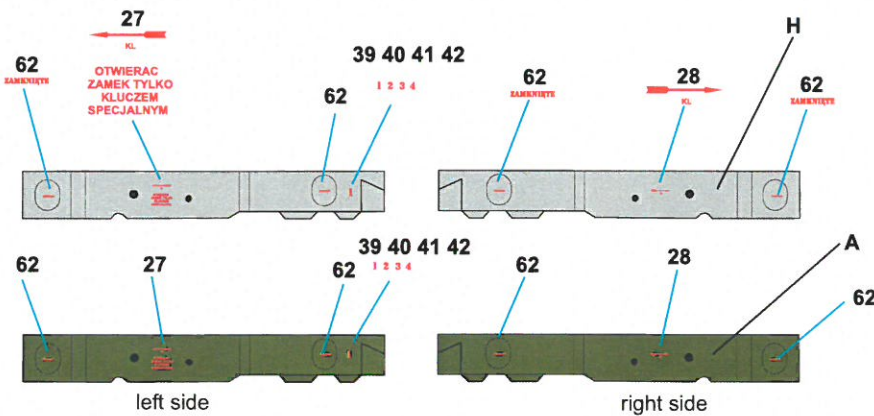

Colors:
Tabela kolorów:

A		FS 34079
B		FS 35450
C		FS 35466
D		FS 25488
E		FS 34255
F		FS 34094
G		FS 36375
H		FS 17178
J	STEEL	