



Bf 109G-6

eduard

32 999

1/35

detail set for 1/35 BORDER MODEL kit • sada detailů pro stavebnici 1/35 BORDER MODEL

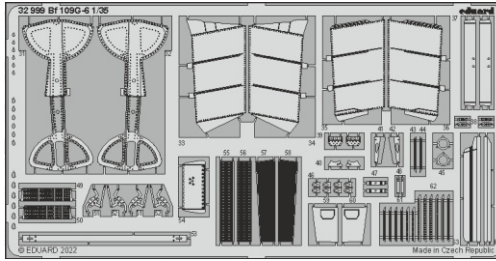
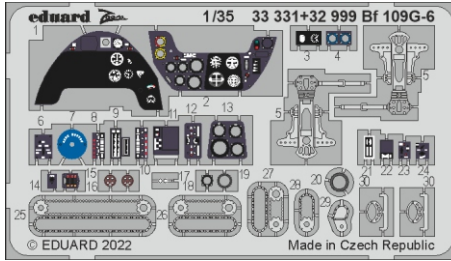

- APPLY EXPRESS MASK AND PAINT BEFORE GLUING
POUŽIT EXPRESS MASK NABARVIT PŘED SLEPENÍM
 - SYMMETRICAL ASSEMBLY
SYMETRICKÁ MONTÁŽ
 - REMOVE
ODSTRANIT
 - GRIND
OBROUSIT
 - DRILL HOLE
VRTAT OTVOR
 - COLORED ETCHED PARTS
LEPTANÉ BAREVNÉ DÍLY
 - ETCHED PARTS
LEPTANÉ NEBAREVNÉ DÍLY
 - ORIGINAL KIT PARTS
PŮVODNÍ DÍLY STAVEBNICE
- BEND
OHNOUT
 - OPTION
VOLBA
 - REPLACE
NAHRADIT

ORIGINAL KIT PARTS
PŮVODNÍ DÍLY STAVEBNICE

PHOTO-ETCHED PARTS
LEPTANÉ DÍLY

PARTS TO BE REMOVED
DÍLY K ODSTRANĚNÍ

FILL
TMELIT

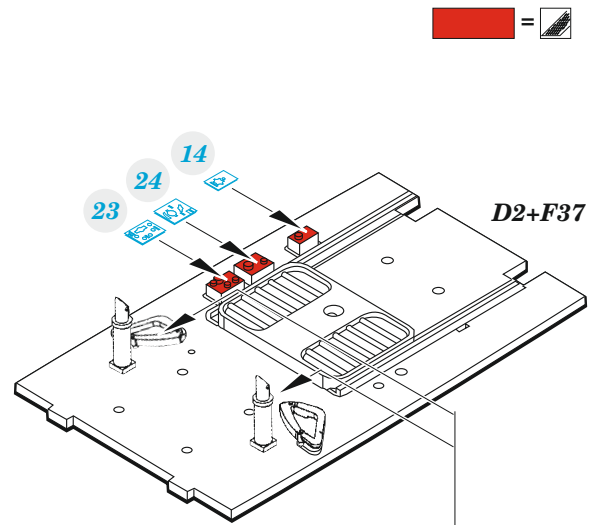
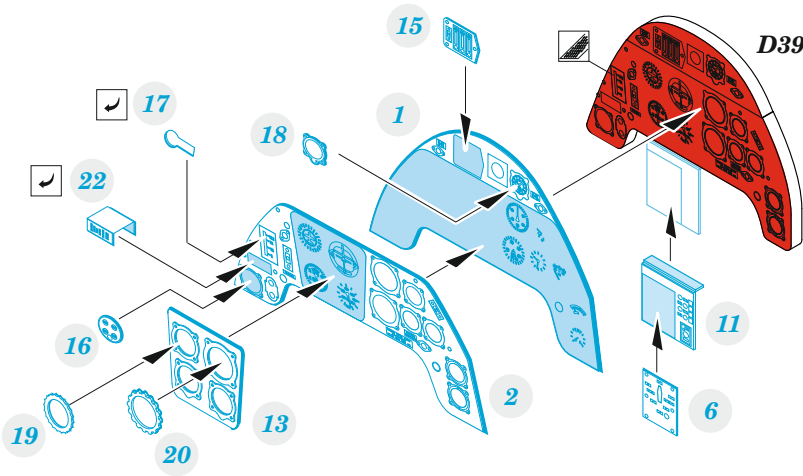

step 1

30

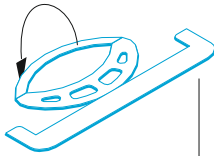

step 2

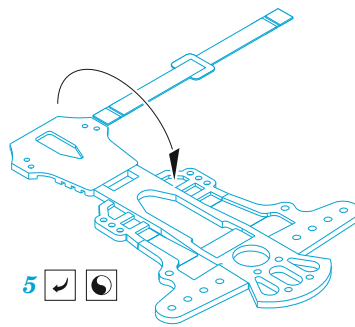
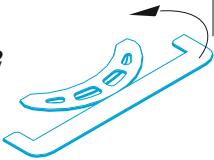

5

