

PANTHERA + 16t STRABOKRAN

w/ Zimmerit
& FULL INTERIOR

1/48 SCALE
NO 001

w/ Maintenance Diorama
& DISPLAY BASE

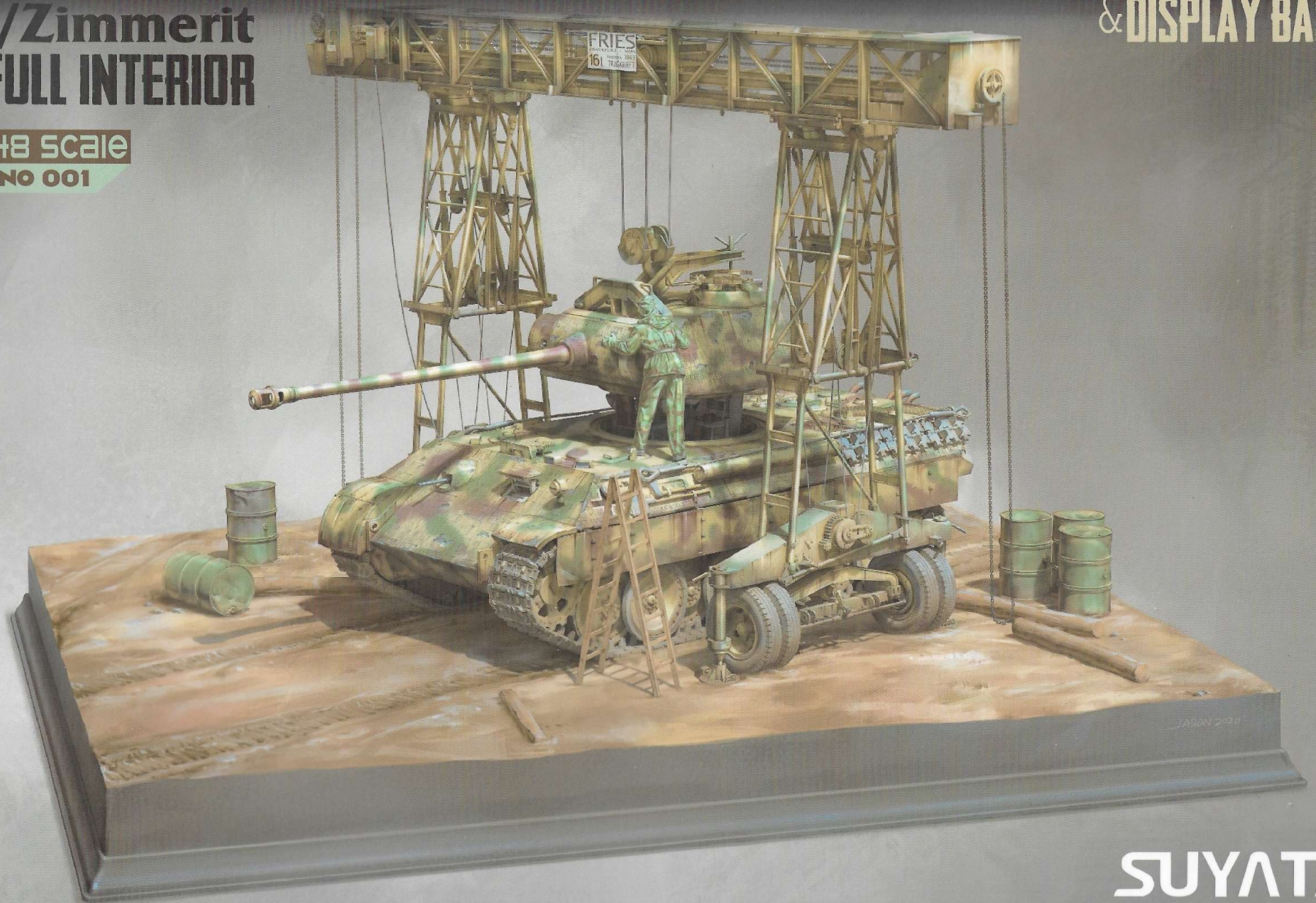

SUYATA®

Caution / 注意 / 警告

1. Don't swallow any items in the package.

部品を誤って飲み込まないようにご注意ください。
請勿吞食產品包裝中的物品。

2. Don't put the package into your mouth, nose or on your head.

ポリ袋を頭から被らないでください。窒息するおそれがあります。
請勿將袋子套在頭上，避免窒息。

3. Keep this product away from fire or high temperature source.

本製品を火気や熱源の近くには置かないでください。
請勿將本產品置于明火或者高溫源附近。

Please pay attention before assembly.

製作する前に必ずお読みください。 / 制作前請注意。

1. Read carefully and fully understand the instructions before commencing assembly.

組立図をよく読み、組立順番に従って組立てて下さい。
請仔細閱讀說明書，并按照說明書標明的步驟進行制作。

2. Check out part numbers before removing parts from sprues.

部品番号を確認して組立てて下さい。
認準零件編號字牌。

3. Confirm the direction and shape of the parts.

部品の向きや形状にご注意ください。
確認零件的方向和形狀。

4. Some parts are sharp, be careful when assembling.

鋭い部品があるため、組立にはご注意ください。
部分零件銳利，組裝時需小心。

5. Adhesives can be used to increase firmness during assembly.

接着剤を使用して組立てることも可能です。
組裝過程中，可使用粘劑增加牢固。

Assembly sequence 組立順番に注意 組裝順序	Make n sets n個作ります 制作n組	Decal デカール 水貼	Optional part 選んで作ります 選擇制作	The other side 向きを変えます 翻轉	Need to use adhesive 接着剤必要 需使用粘合劑	Same for both sides 反対側も同様に作り 對側相同

Cyanoacrylate glue 瞬間接着剤 強力膠	Zimmerit decal ツィンメリットデカール 防磁水貼	PE parts エーチング 蝕刻片	Drilling 穴を開けます 鑽孔	Confirm the direction and shape of the parts 部品の向きと形状に注意して下さい 注意零件的方向和形狀

Tools ツール 工具	Pliers 切っさてレンチ 剪鉗	Cement 接着剤 膠水	Modeler's knife ペンナイフ 筆刀	Tweezers ピンセット 鑷子

Applying decals / 貼り方 / 水貼使用方法



01
Cut out decal design from sheet
貼りたいマークを切り抜きます
將水貼剪下



02
Dip the decal in the tepid water
for 15~20 sec
マークをぬるま湯に15秒から20秒まで浸します
將水貼在溫水中浸泡15至20秒

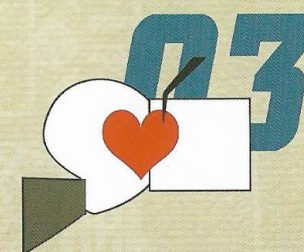

03
Hold the backing sheet edge and
slide decal onto the model
マークをスライドさせてモデルに移します
將水貼從底紙上移至模型



04
Move decal onto position with cotton
swab, press decal gently down until
excess water and air bubbles are gone
綿棒でマークを正しい位置にずらして、
気泡や水分をとり
用棉棒將水貼調整到相應位置，并將水
份和氣泡擠壓出

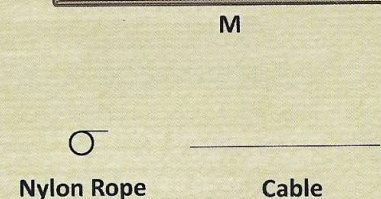
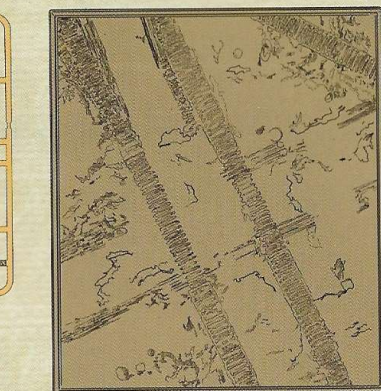
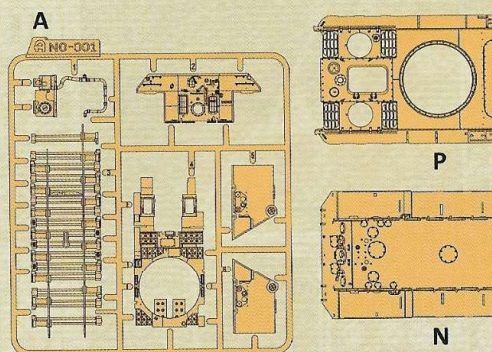
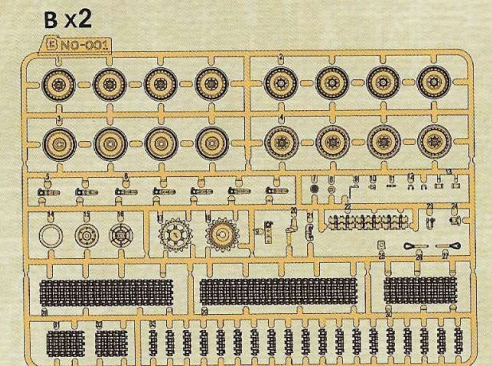
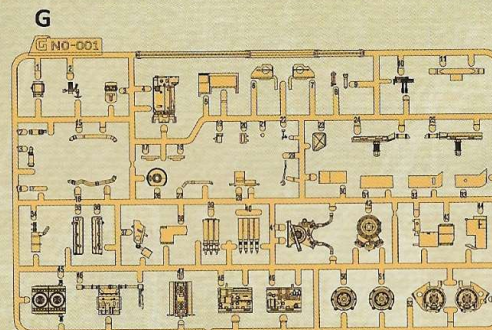
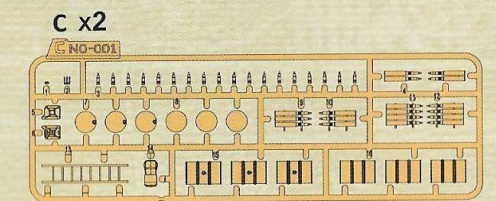
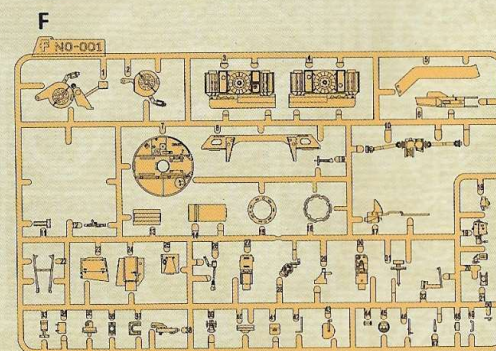
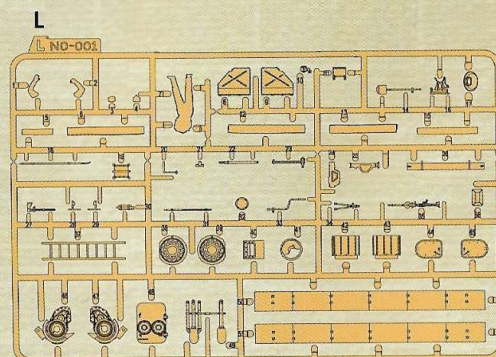
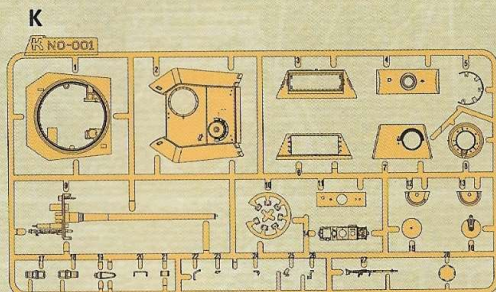
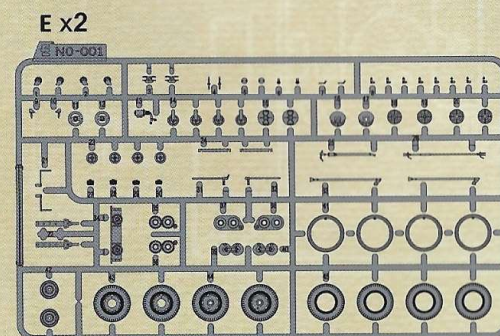
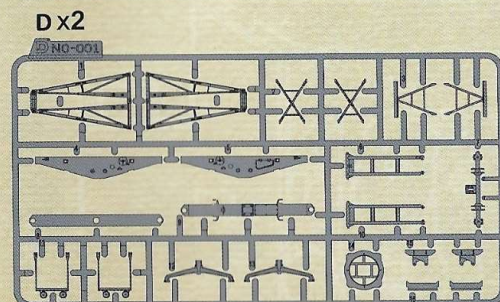
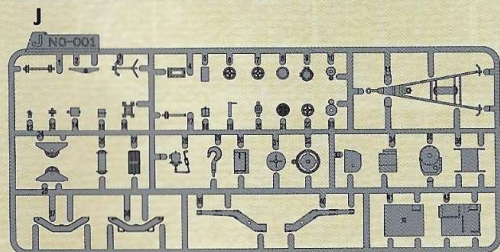
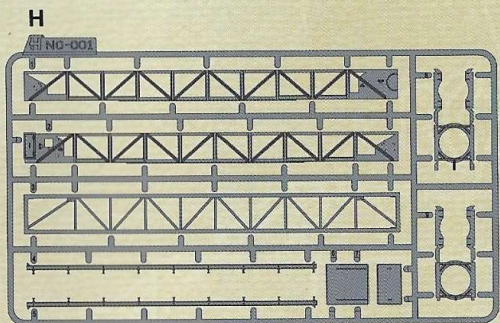

Nylon Rope

Cable

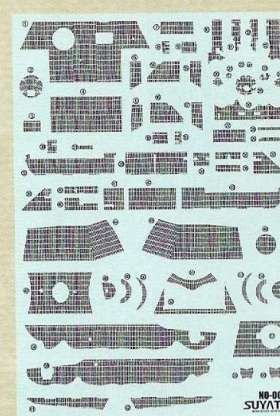
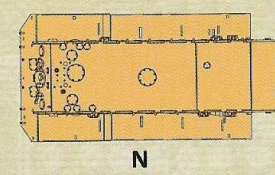
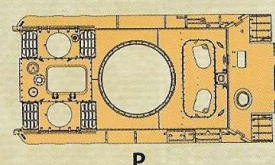

Zimmerit Decal

防磁水贴指示

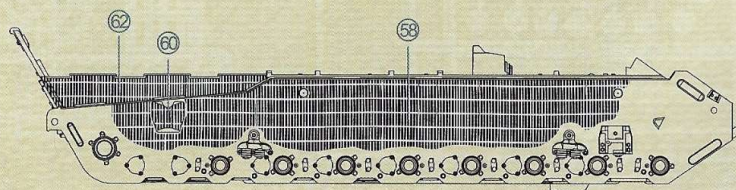
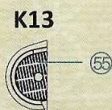
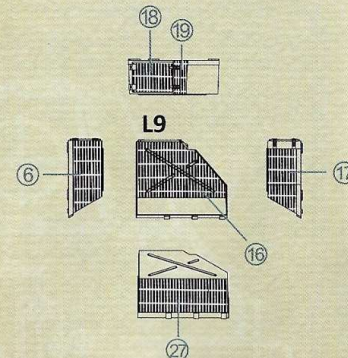
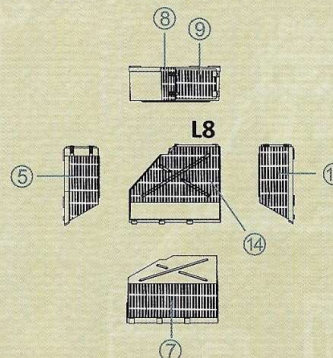
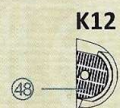
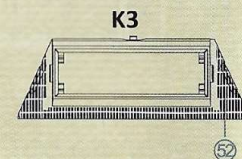
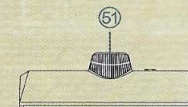
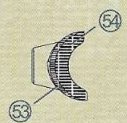
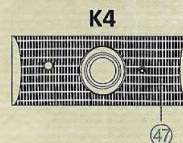
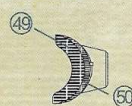
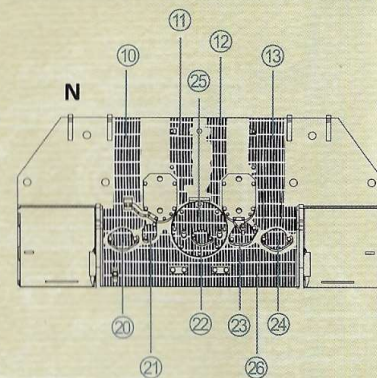
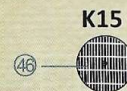
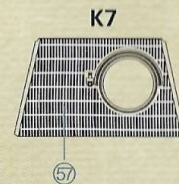
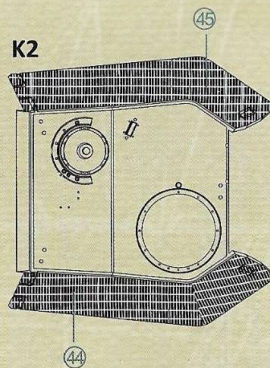
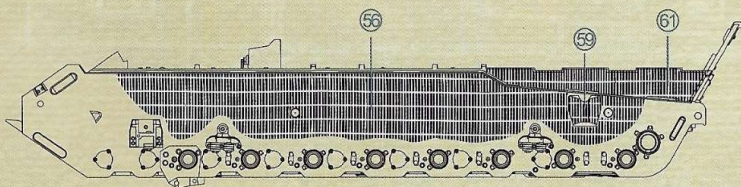
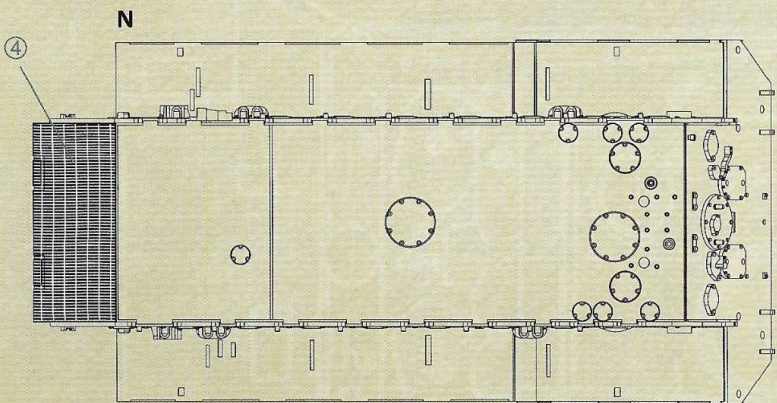
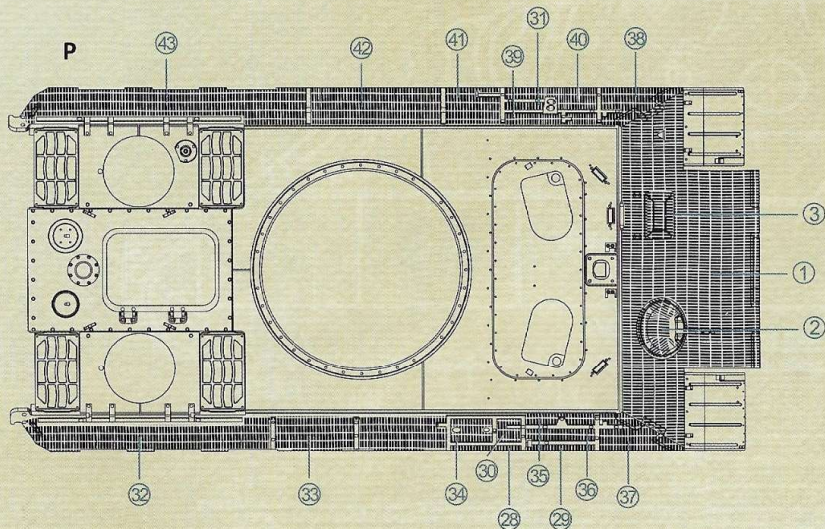

Painting 上色指示

Interior Painting Panther A Family

Color info and profiles by

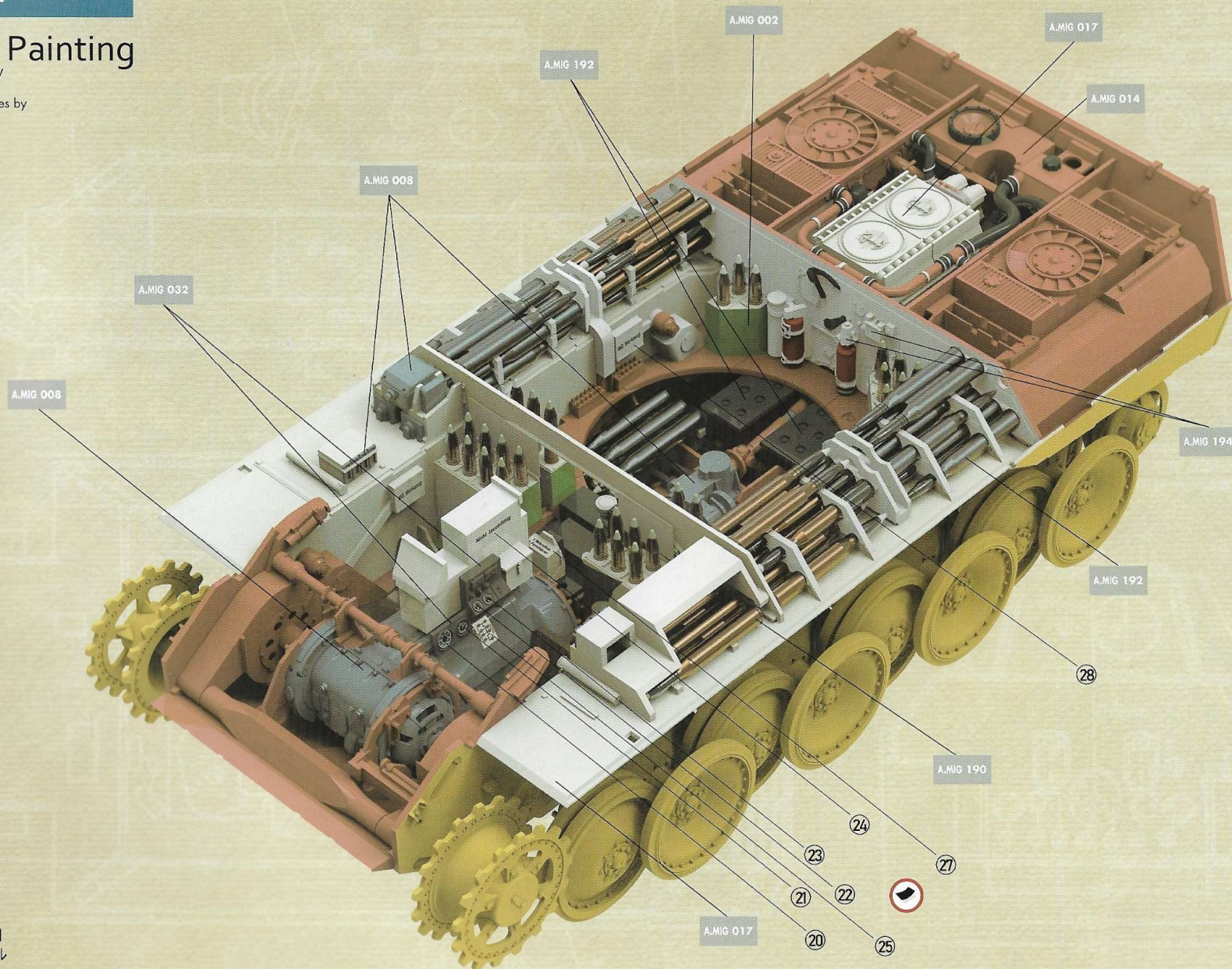

 Decal
デカル
水貼



SUYATA

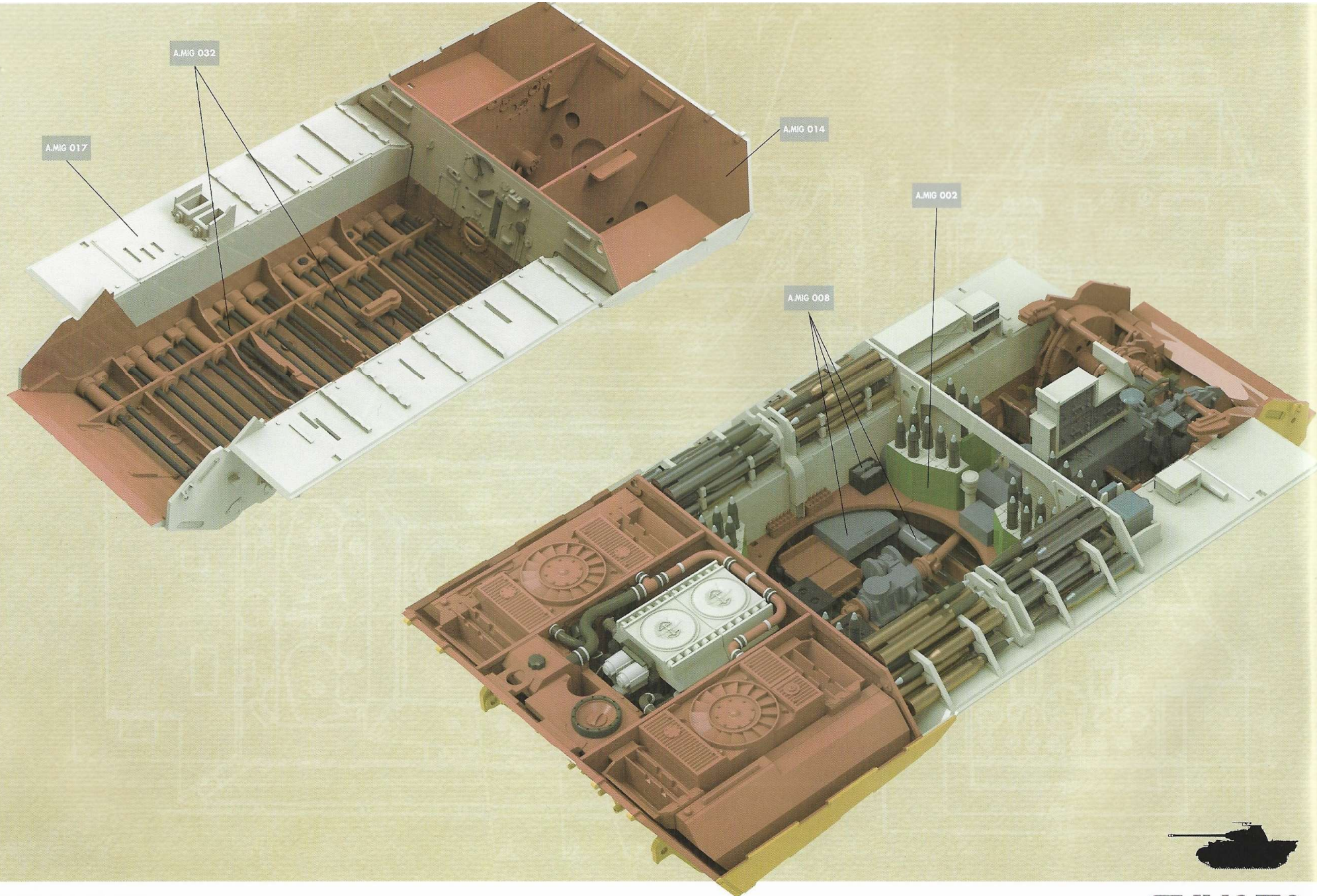

SUYATA

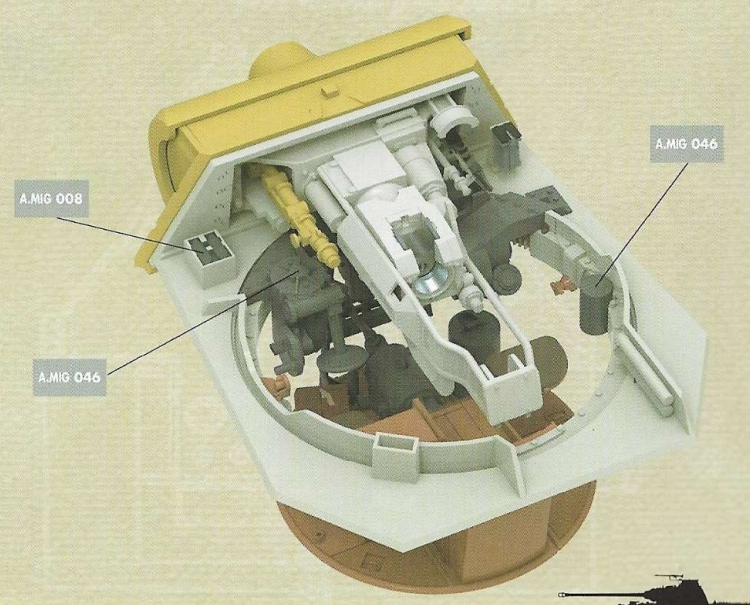
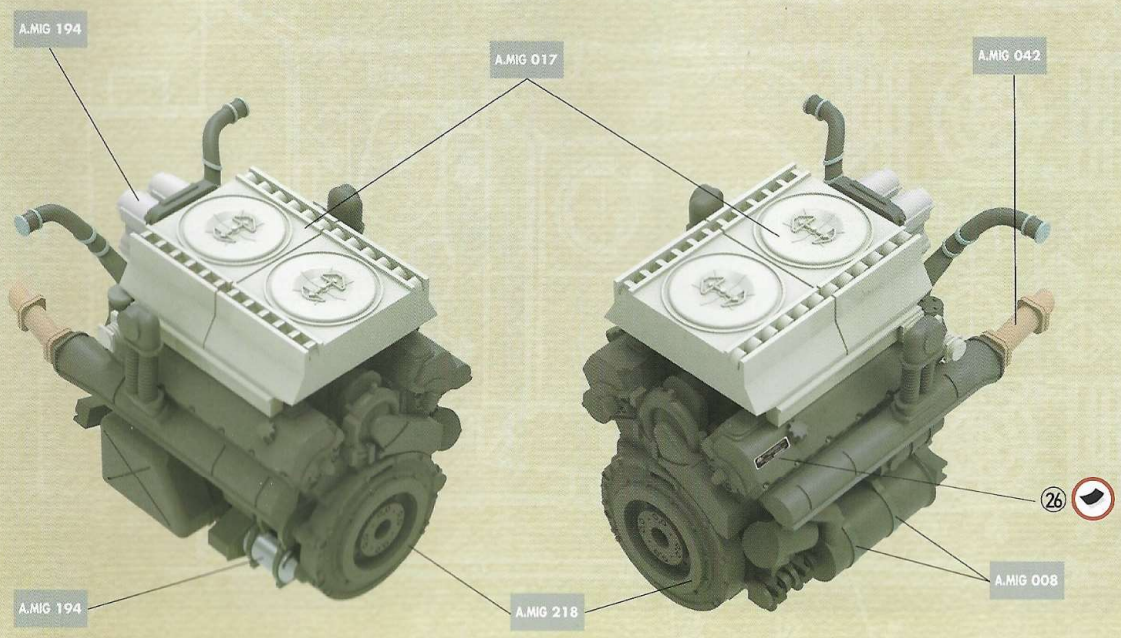
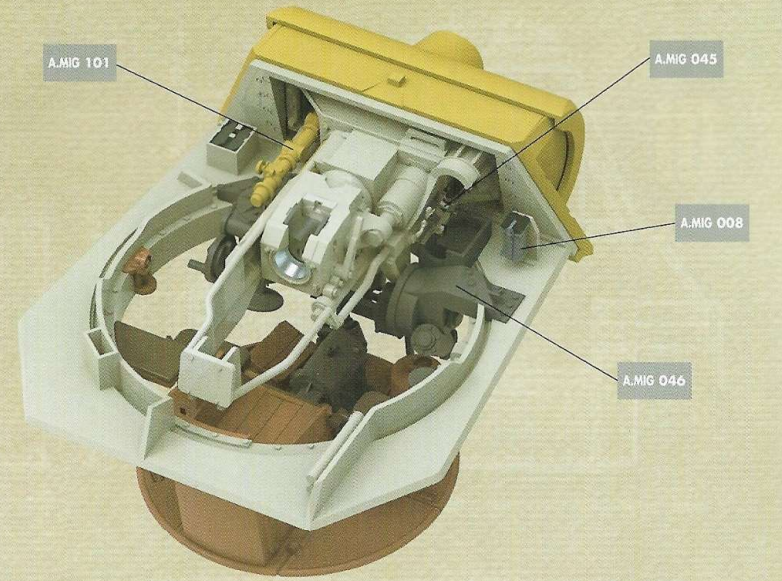
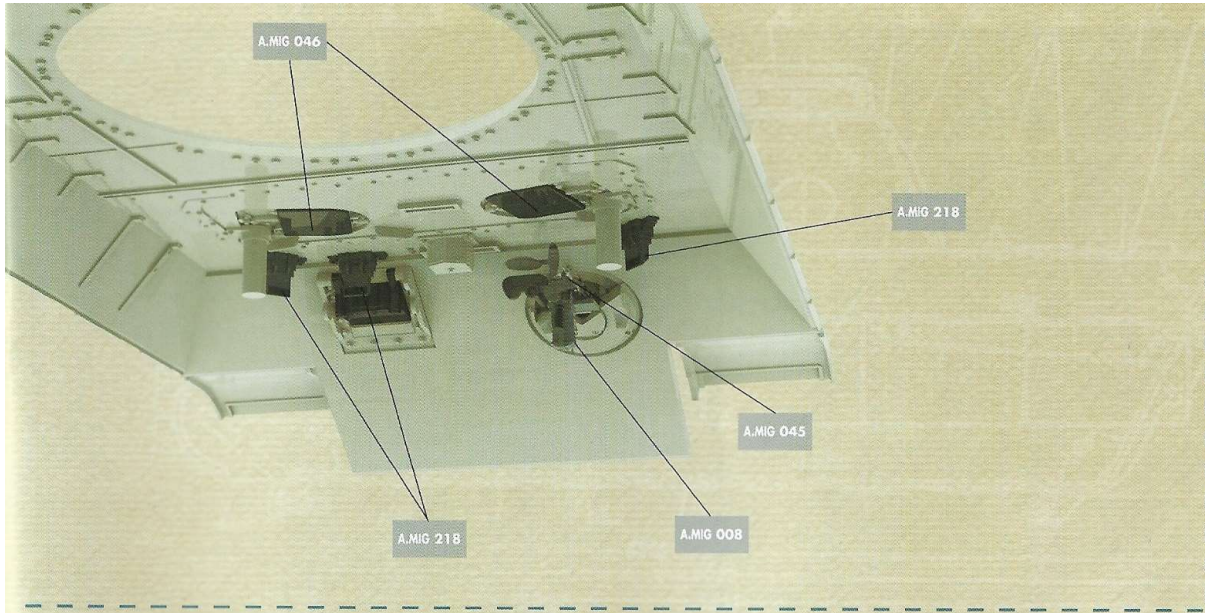

SUYATA

01

扭杆安装 1



Attaching torsion bars 1

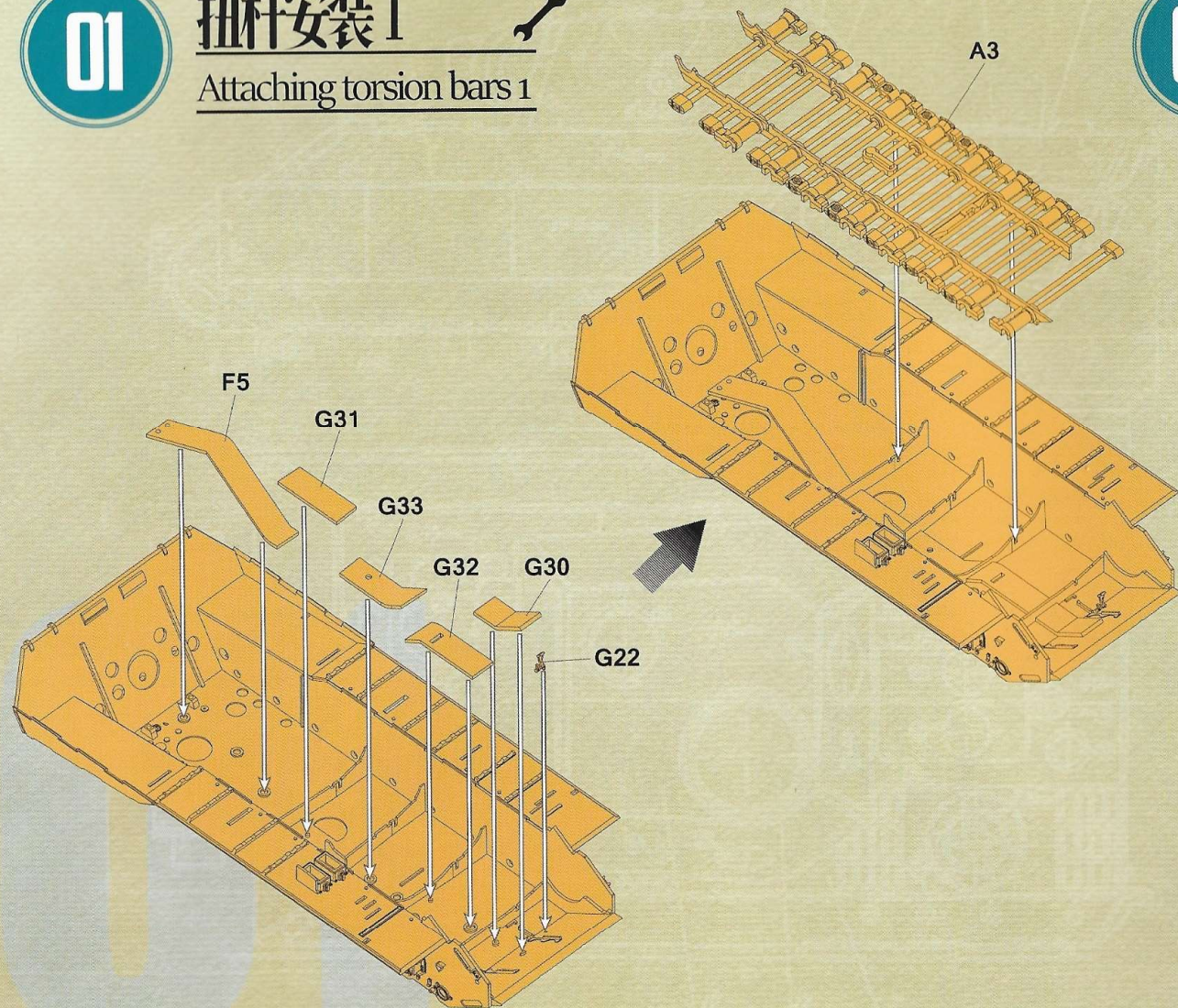

02

变速箱安装 1



Attaching gearbox 1

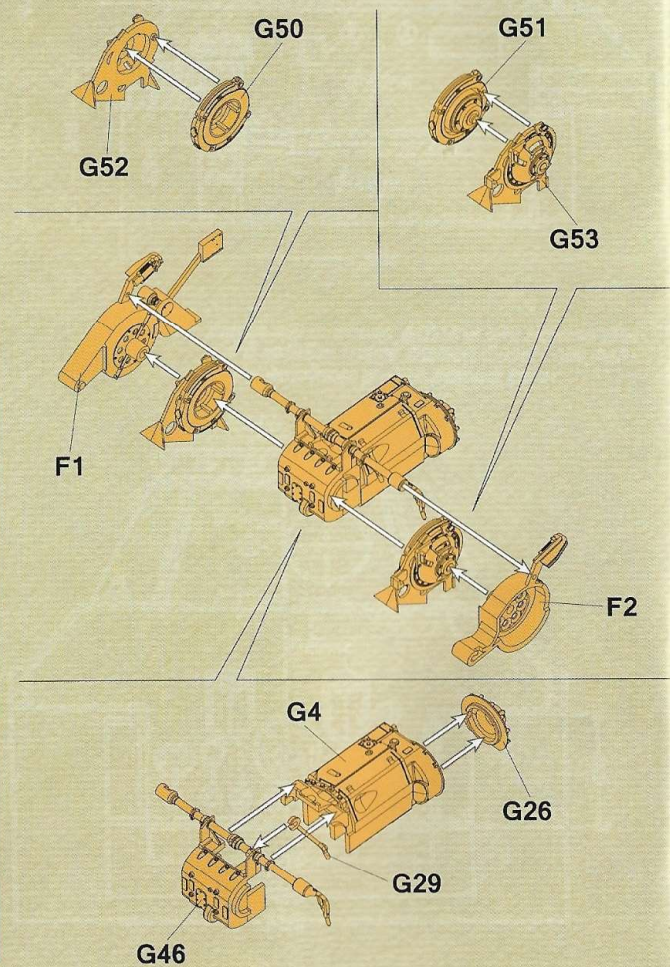

03

变速箱安装 2 

Attaching gearbox 2

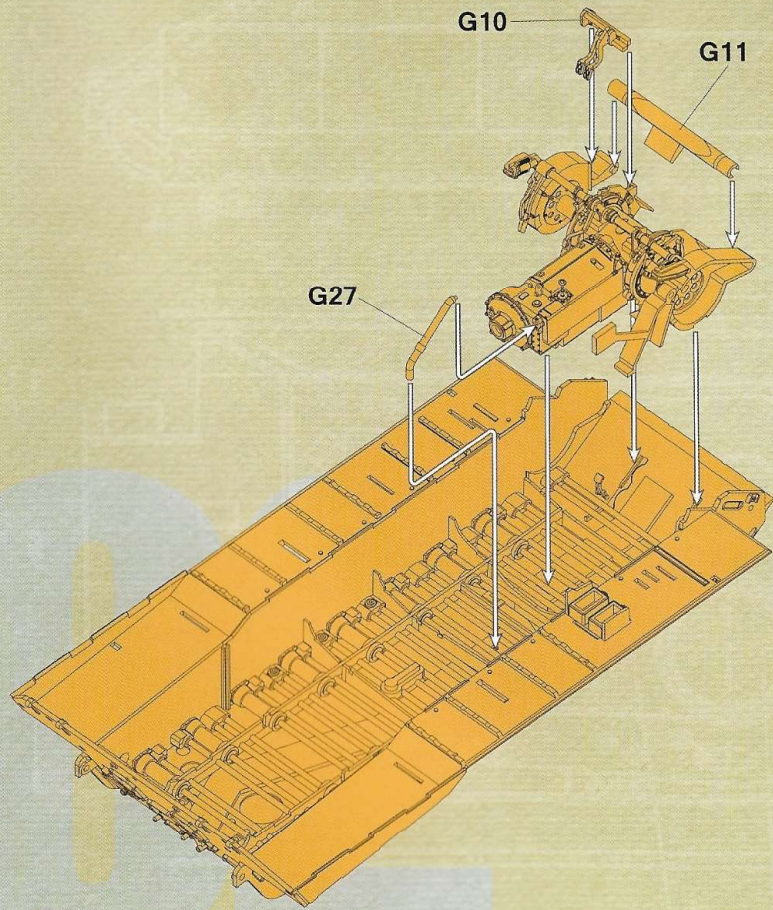

04

扭杆安装 2 

Attaching torsion bars 2

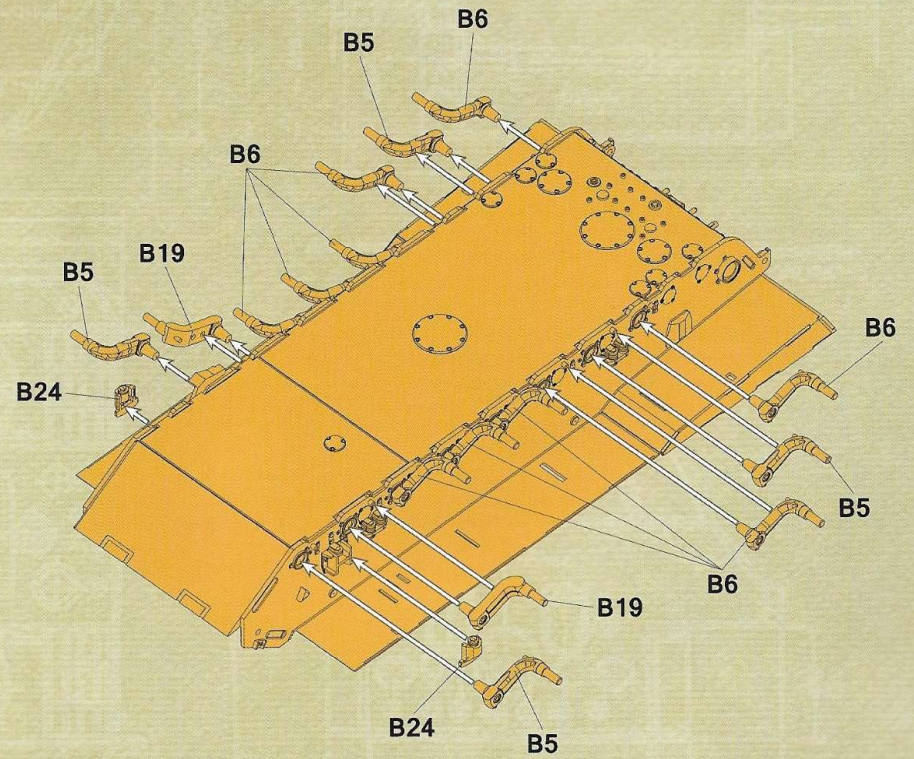

05

负重轮安装



Attaching road wheels

06

主动轮安装



Attaching drive sprockets

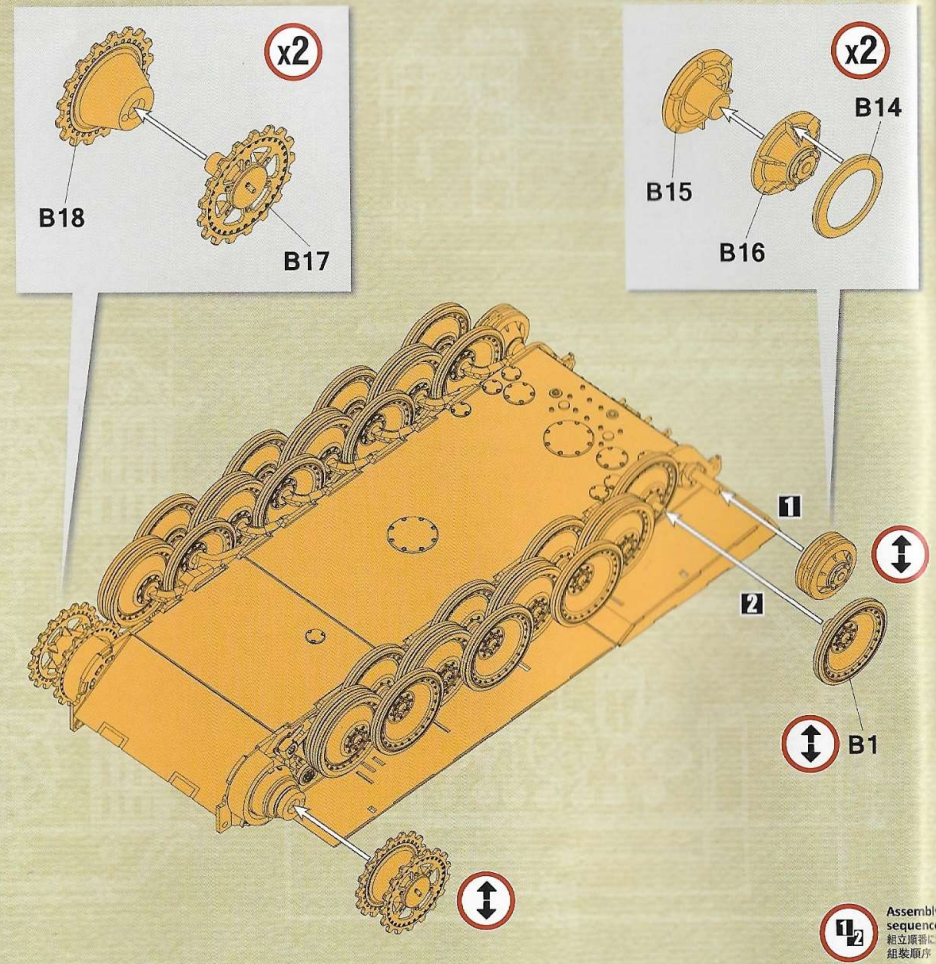
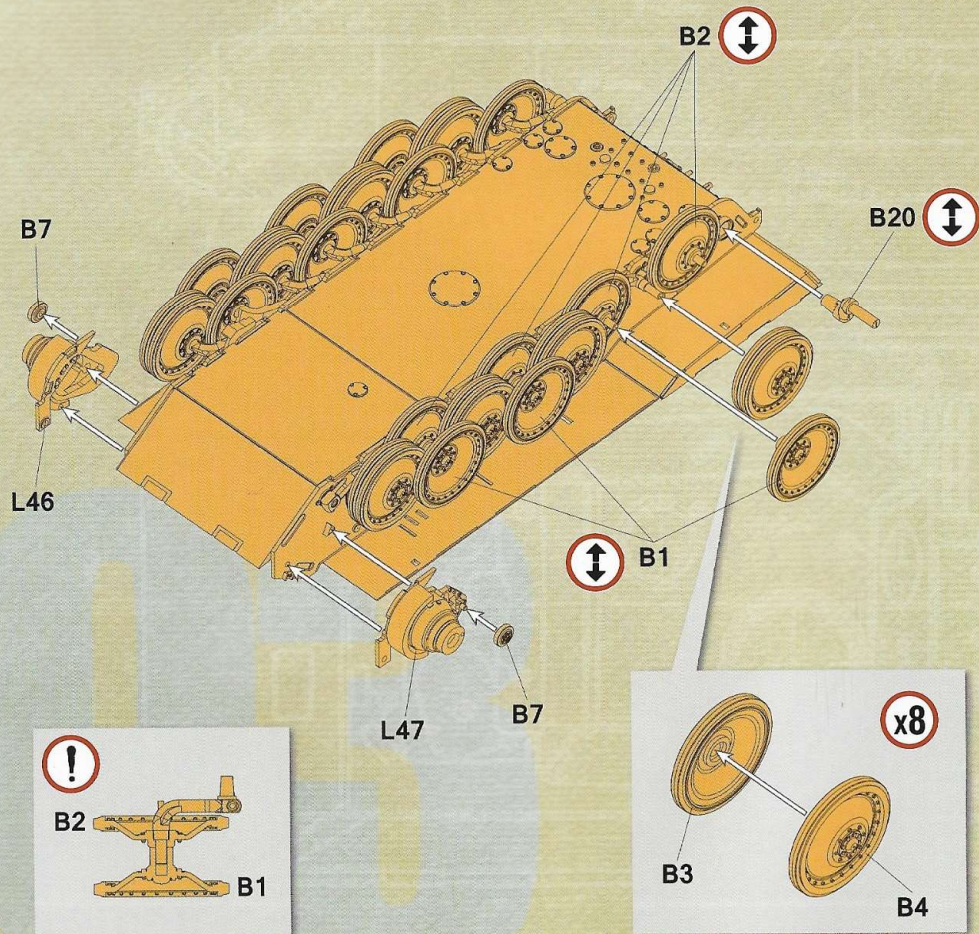

Assembly sequence
装配顺序

07

内部组装 1



Internal structure assembly 1

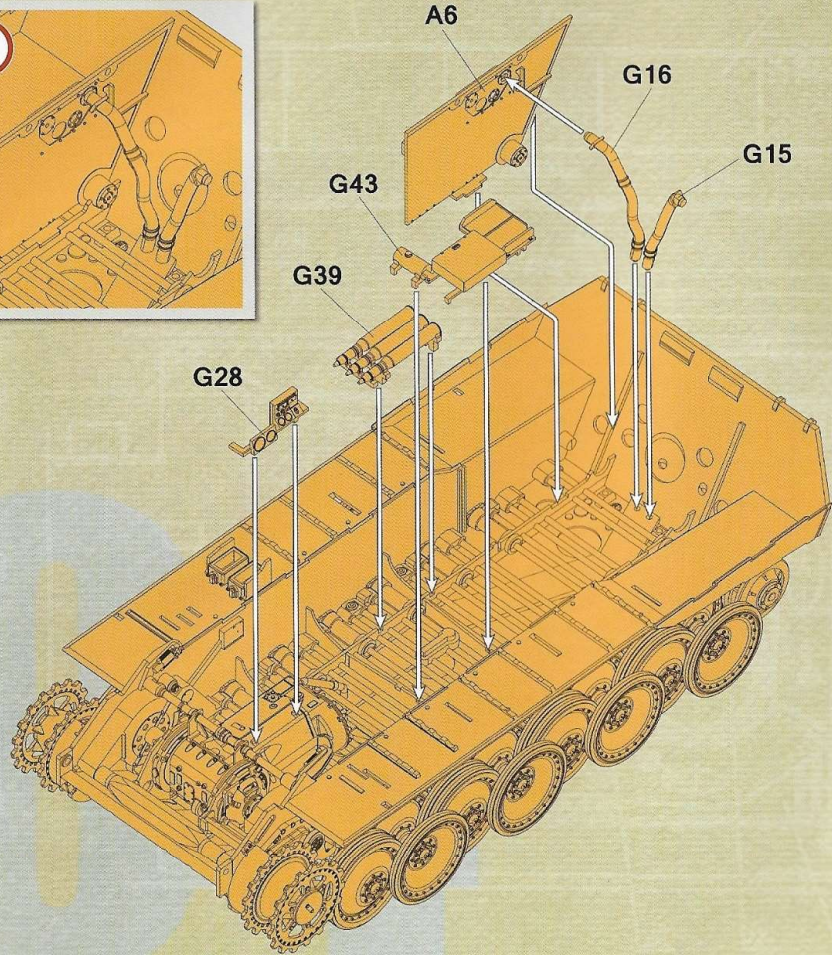

08

发动机组安装 1



Attaching engine 1

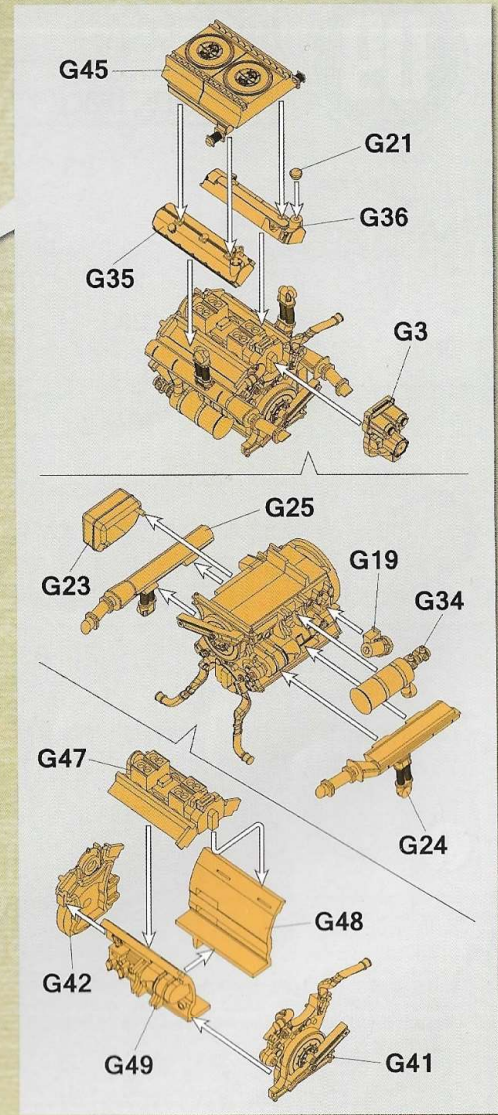
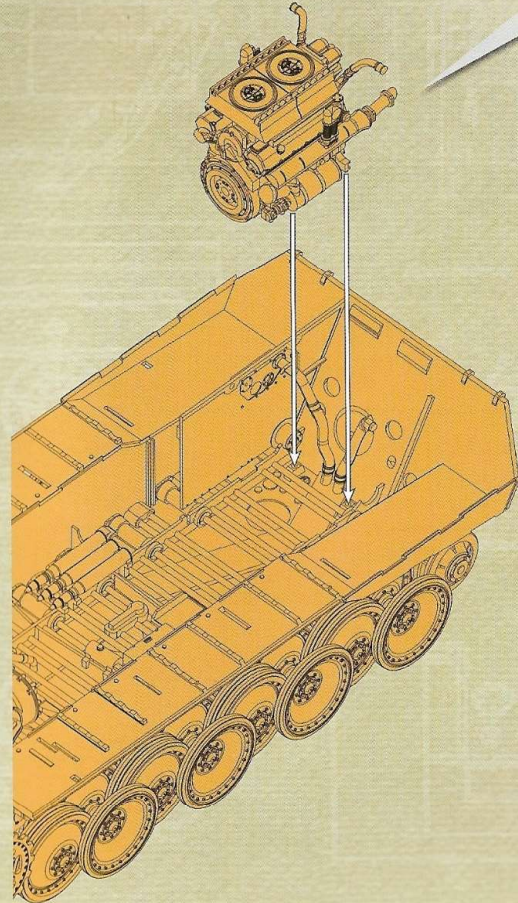

09

履帶安裝



Attaching tracks

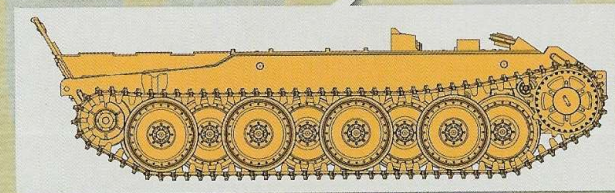
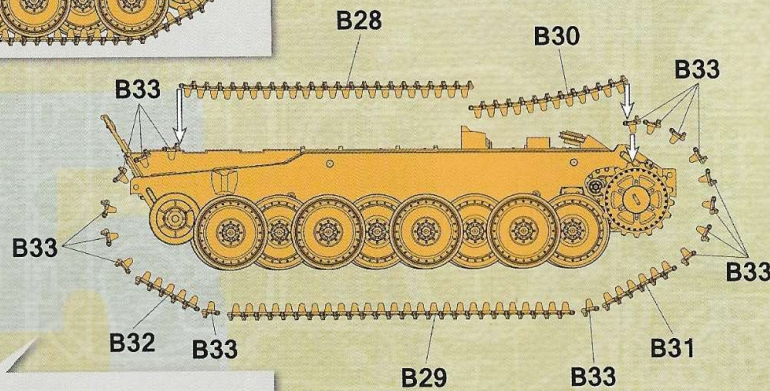
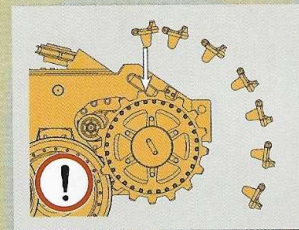
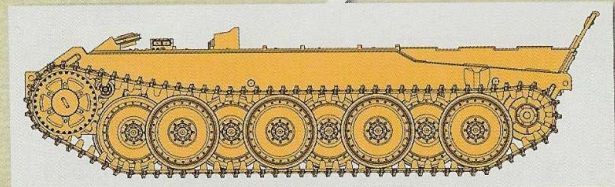
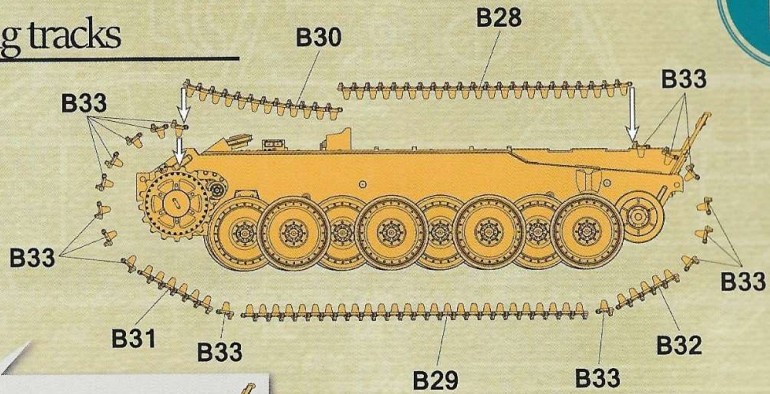
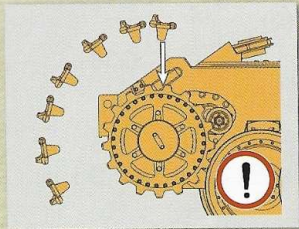

10

內部組裝 2



Internal structure assembly 2

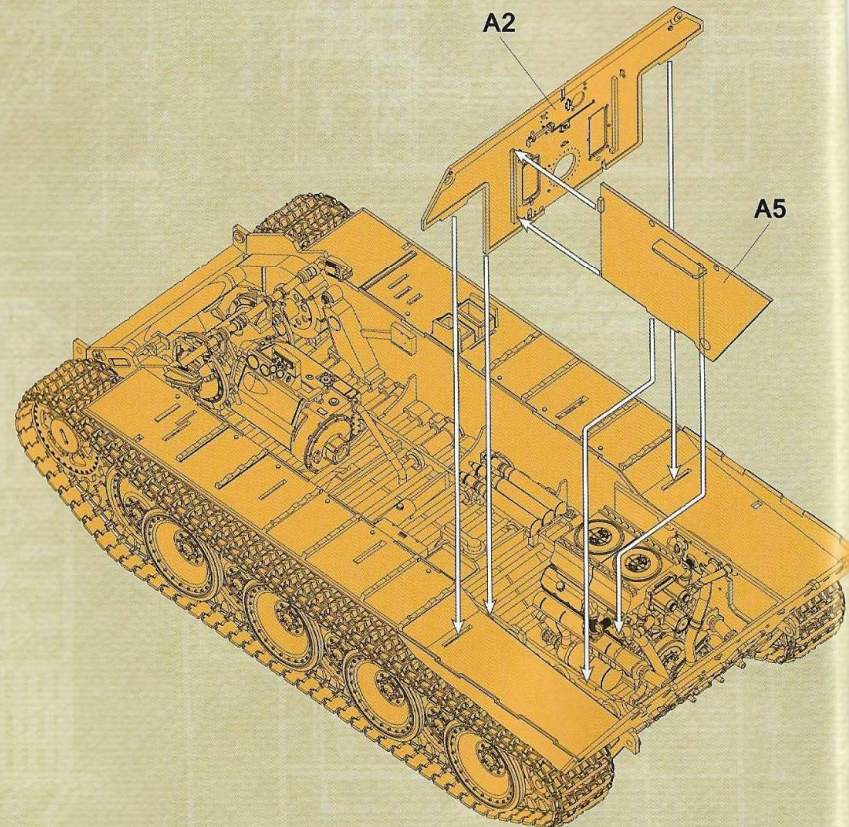

11

发动机组安装 2

Attaching engine 2

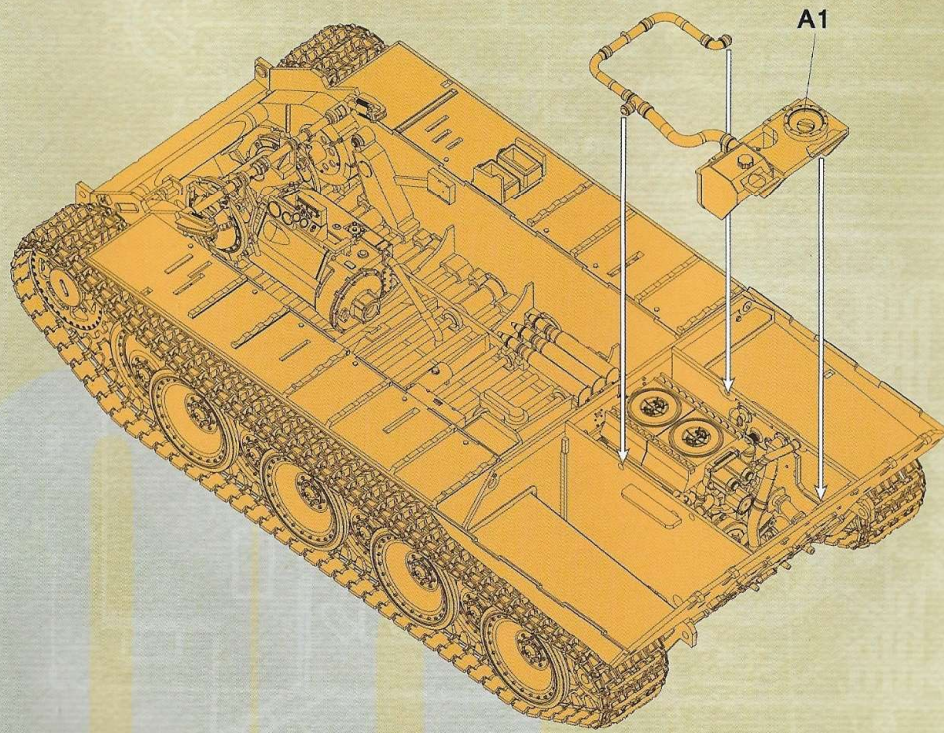

12

内部组装 3

Internal structure assembly 3

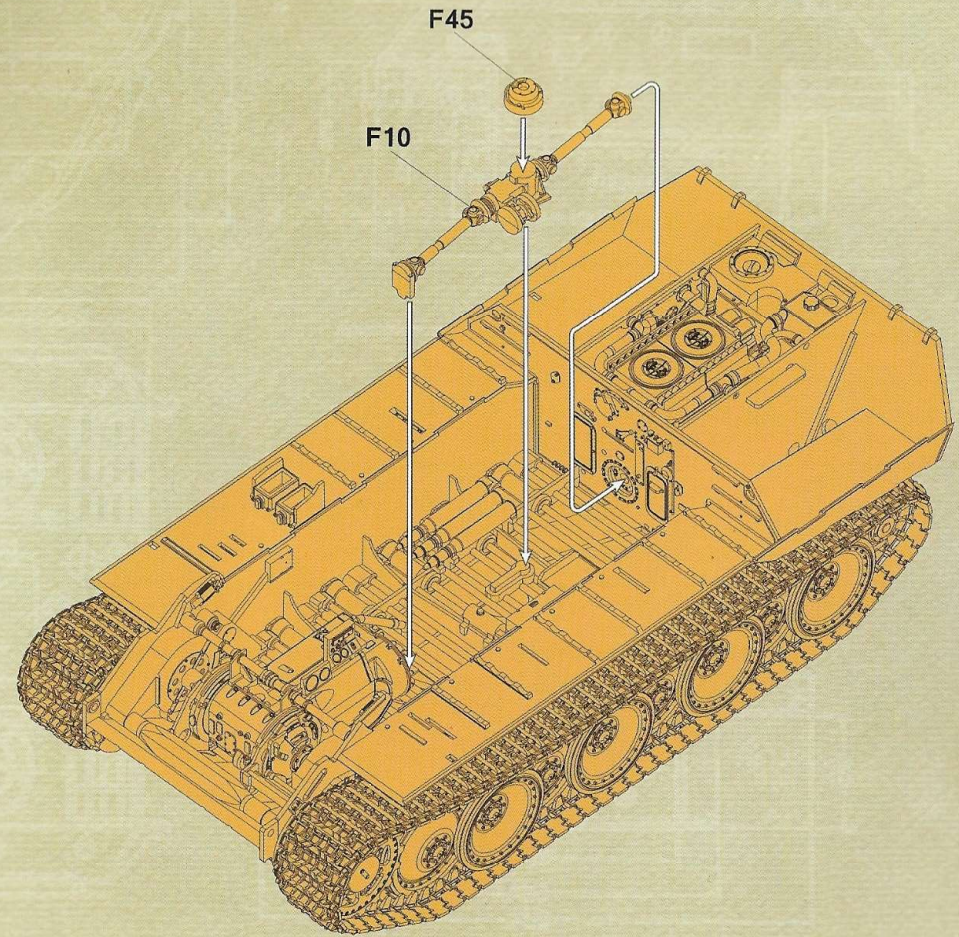

13

战斗室组装 1



Fighting compartment assembly 1

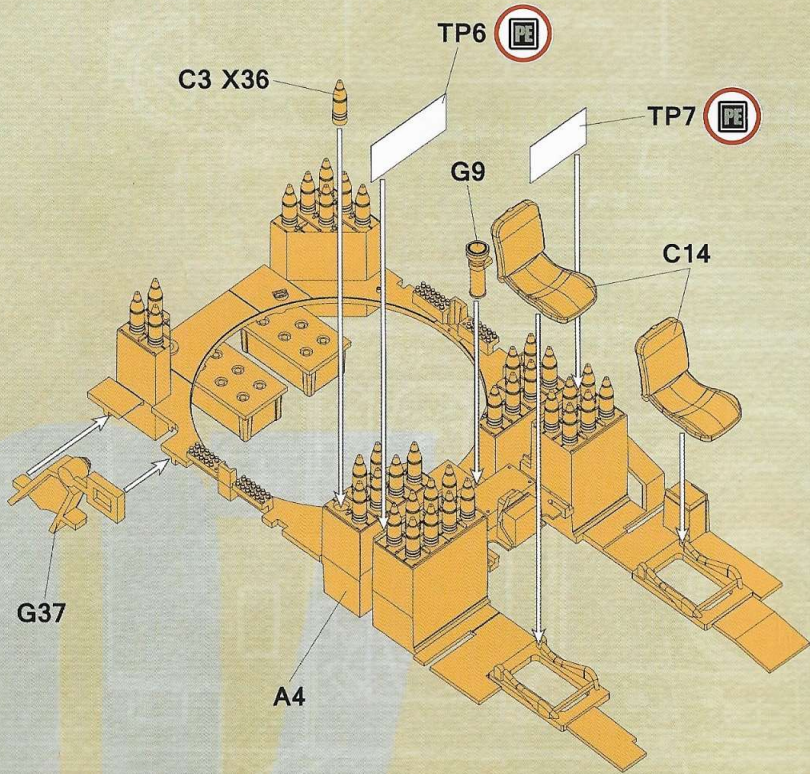

14

战斗室组装 2



Fighting compartment assembly 2

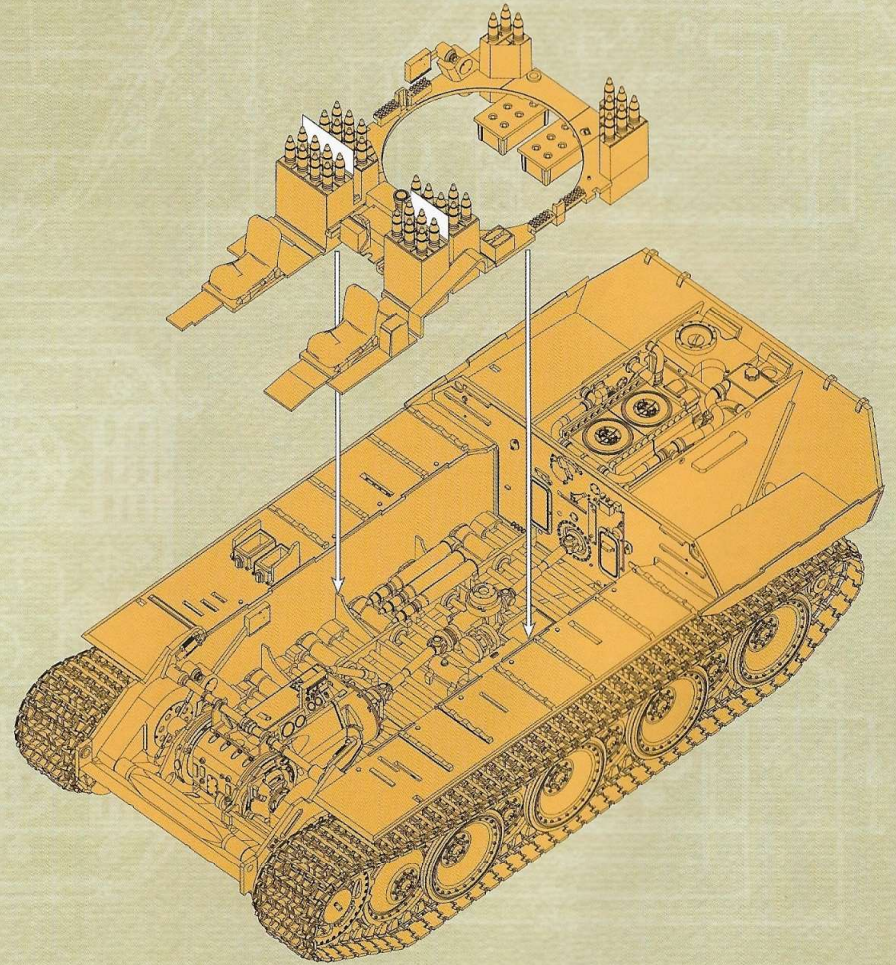

15

战斗室组装 3

Fighting compartment assembly 3

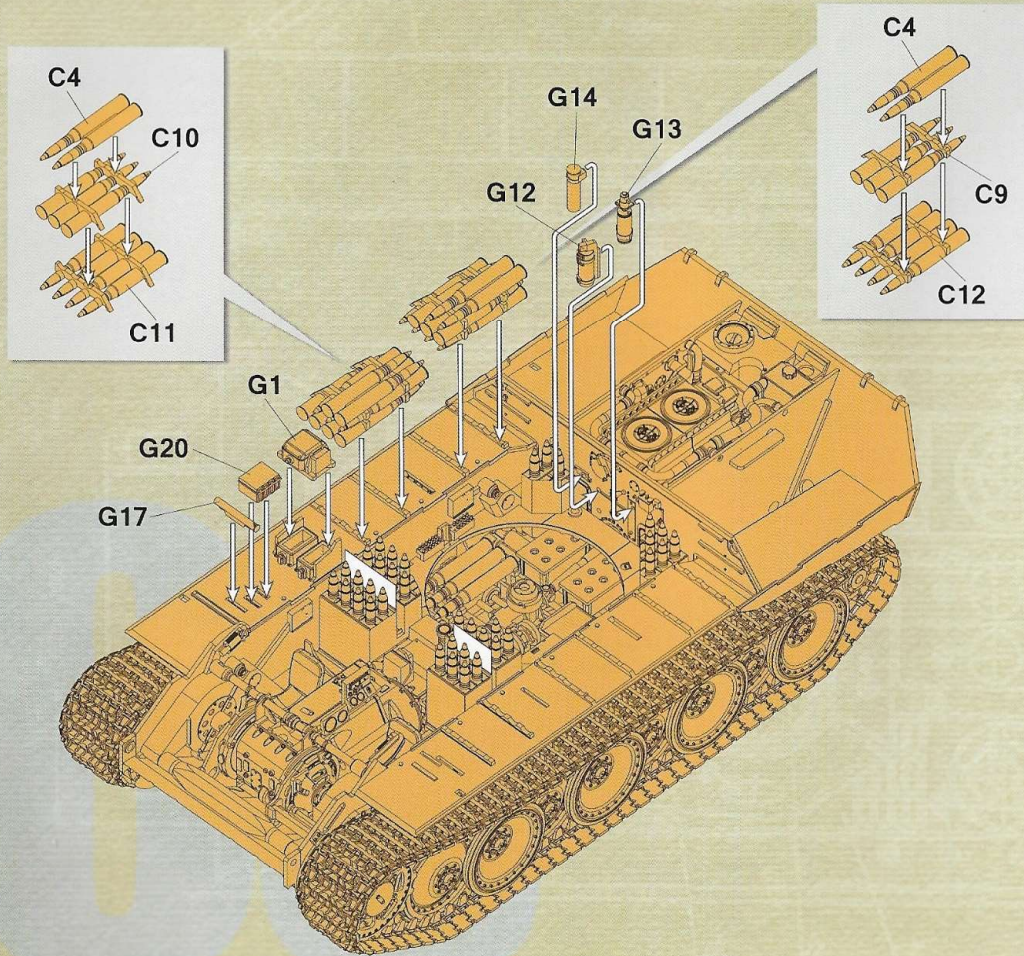

16

战斗室组装 4

Fighting compartment assembly 4

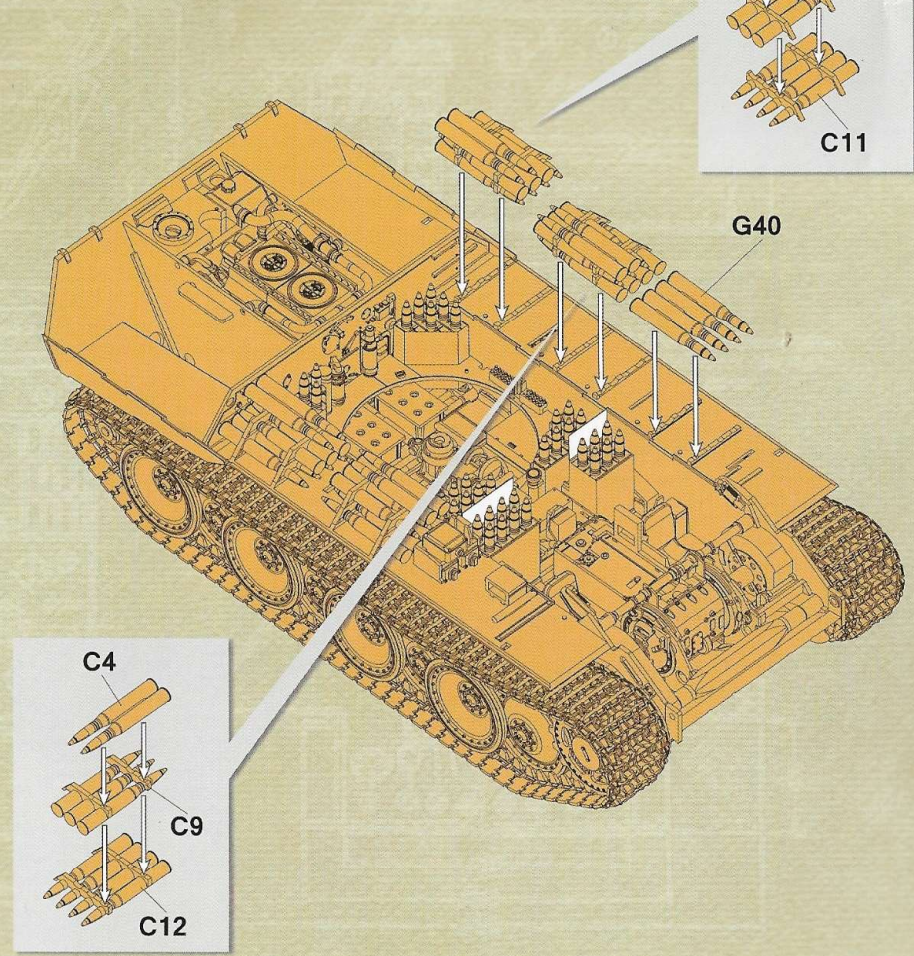

17

内部组装 4



Internal structure assembly 4

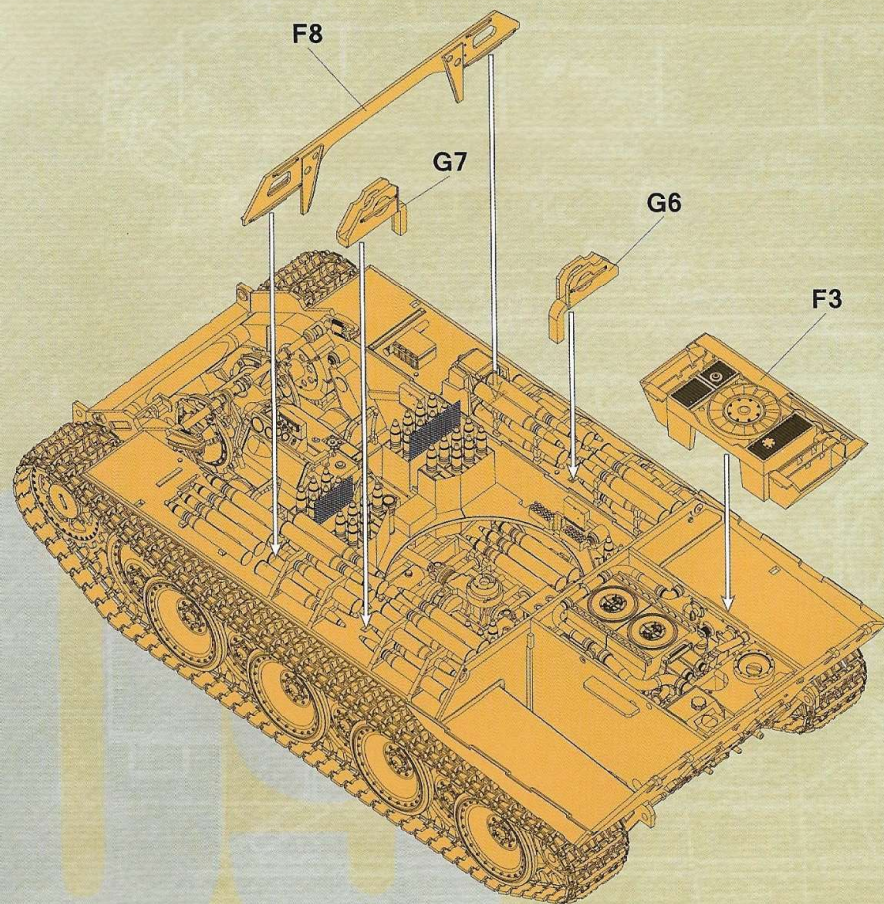

18

内部组装 5



Internal structure assembly 5

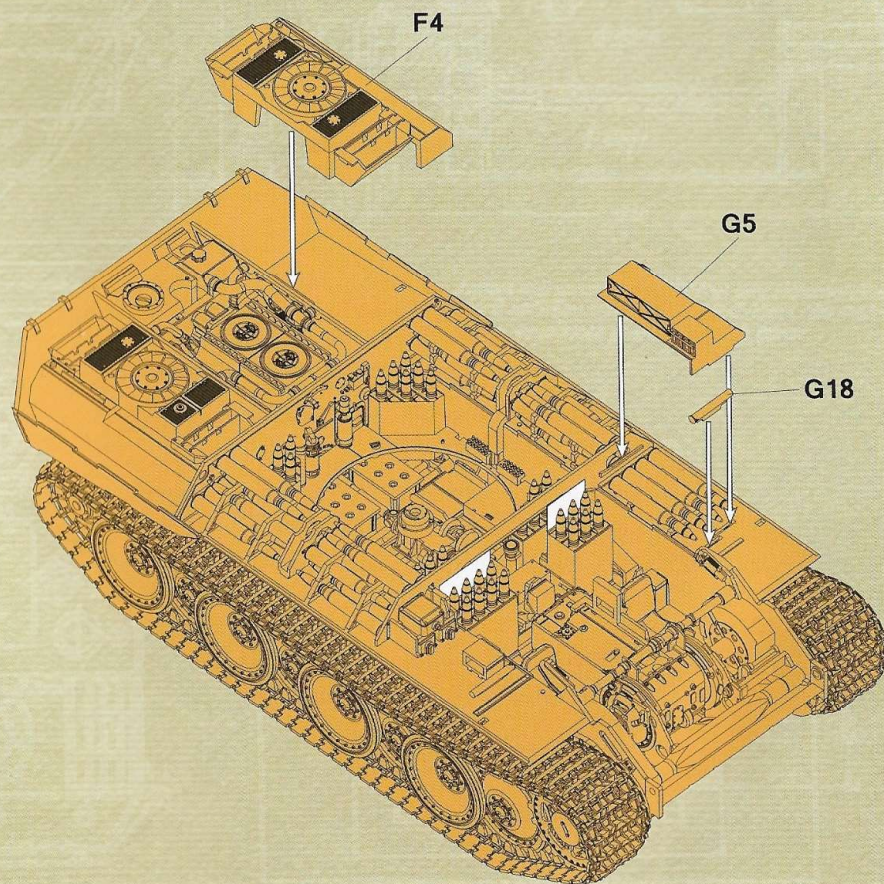

19

排气管安装



Attaching exhaust pipes

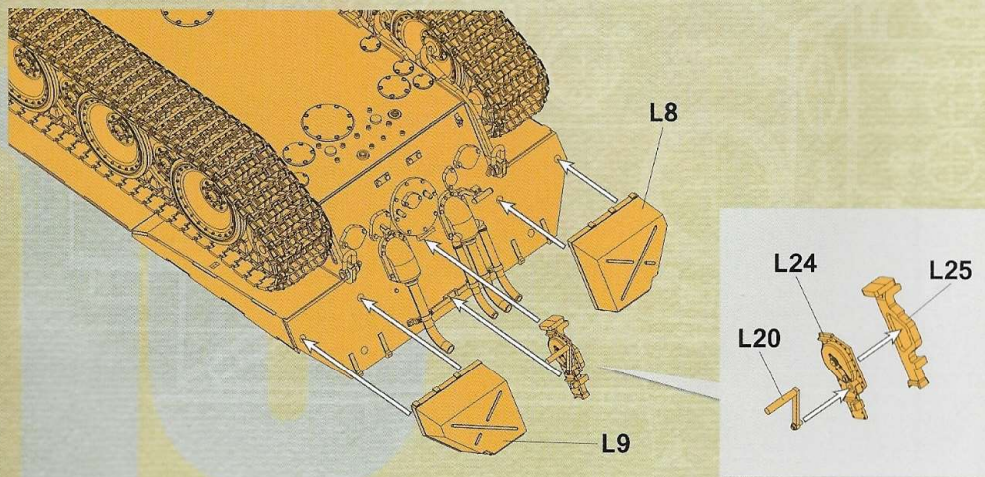
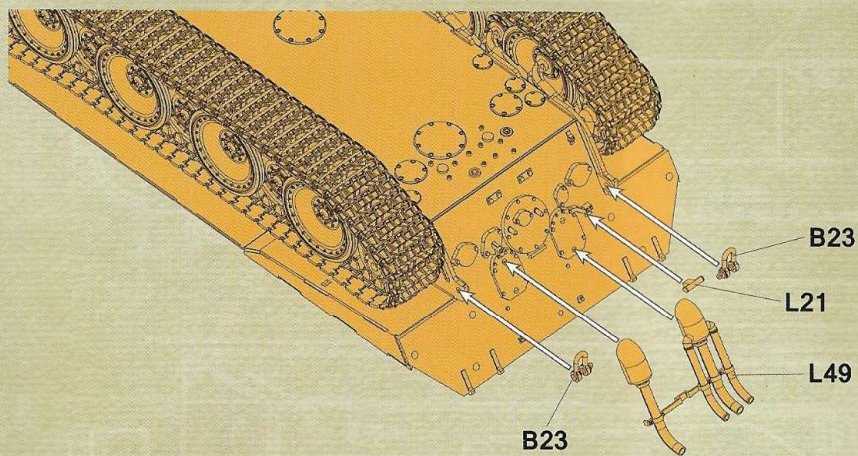

20

车体组装 1



Hull assembly 1

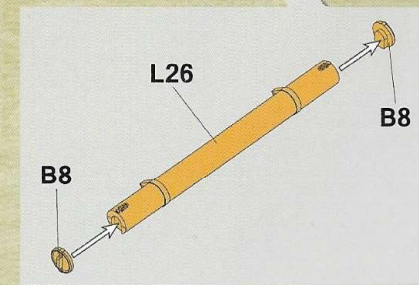
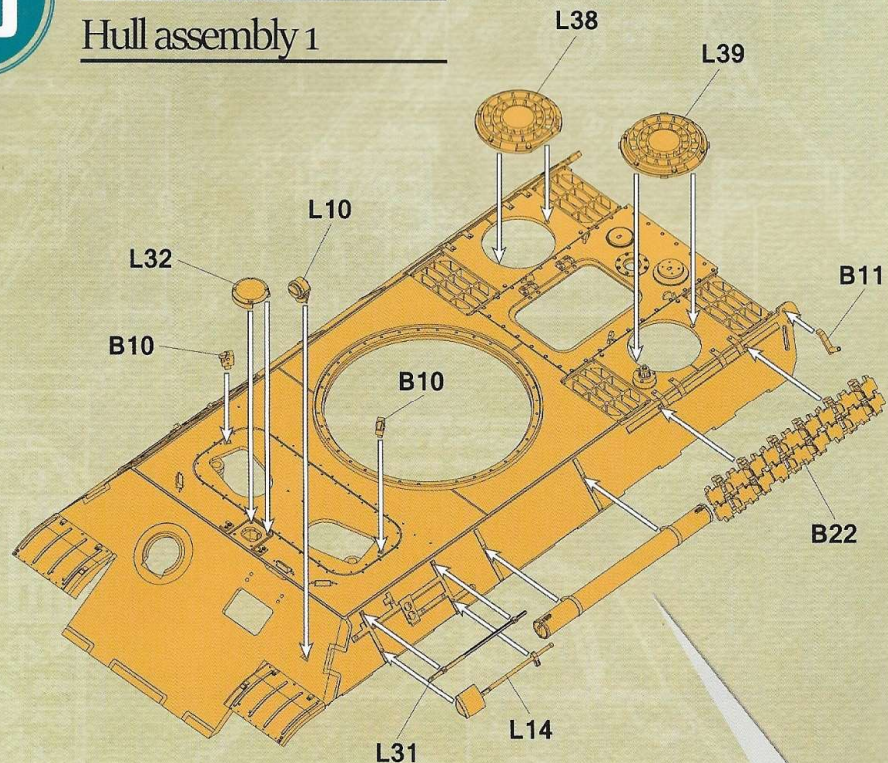

21

车体组装 2

Hull assembly 2

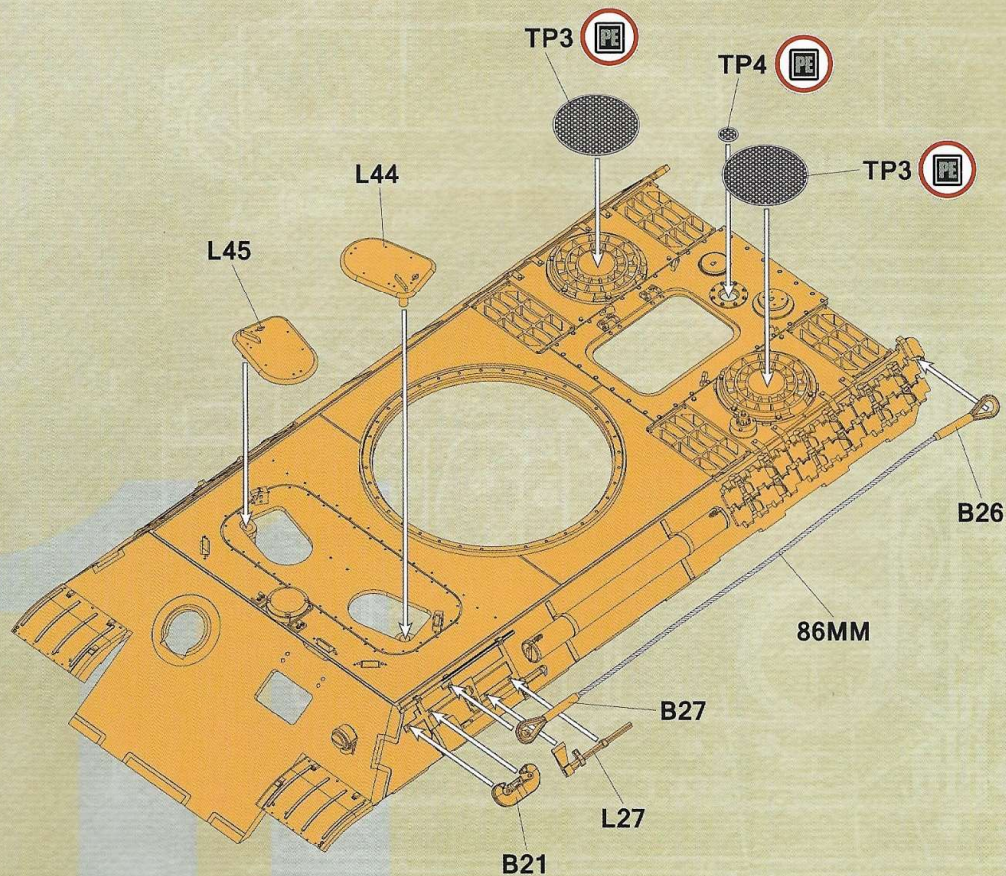

22

车体组装 3

Hull assembly 3

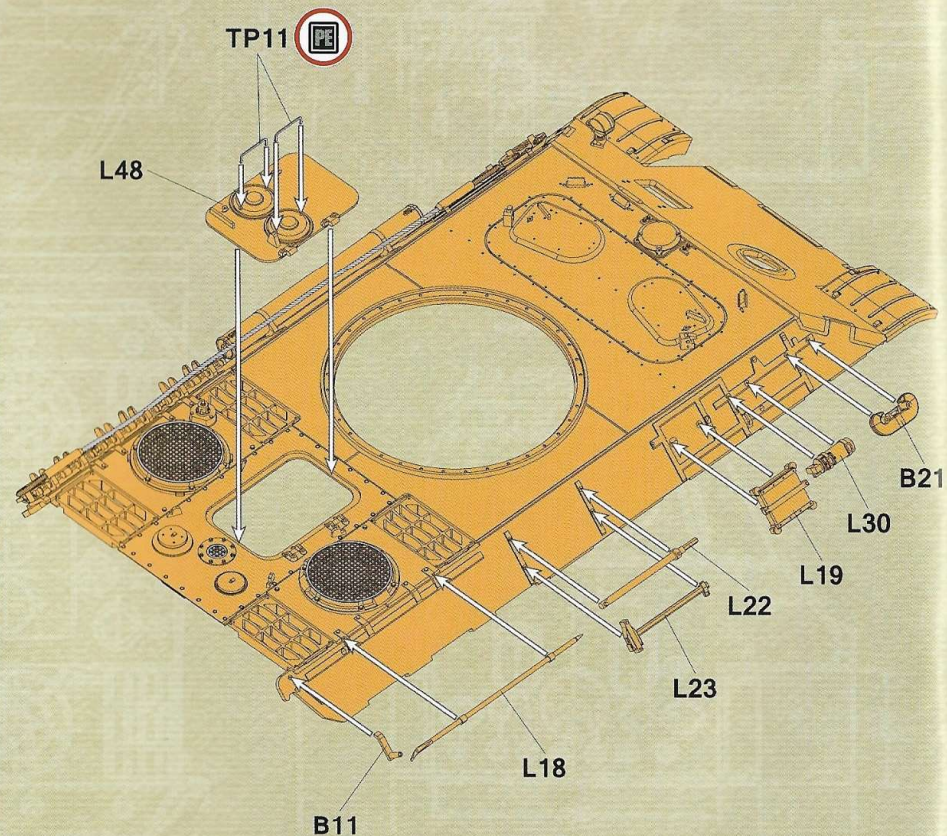

23

车体组装 4

Hull assembly 4

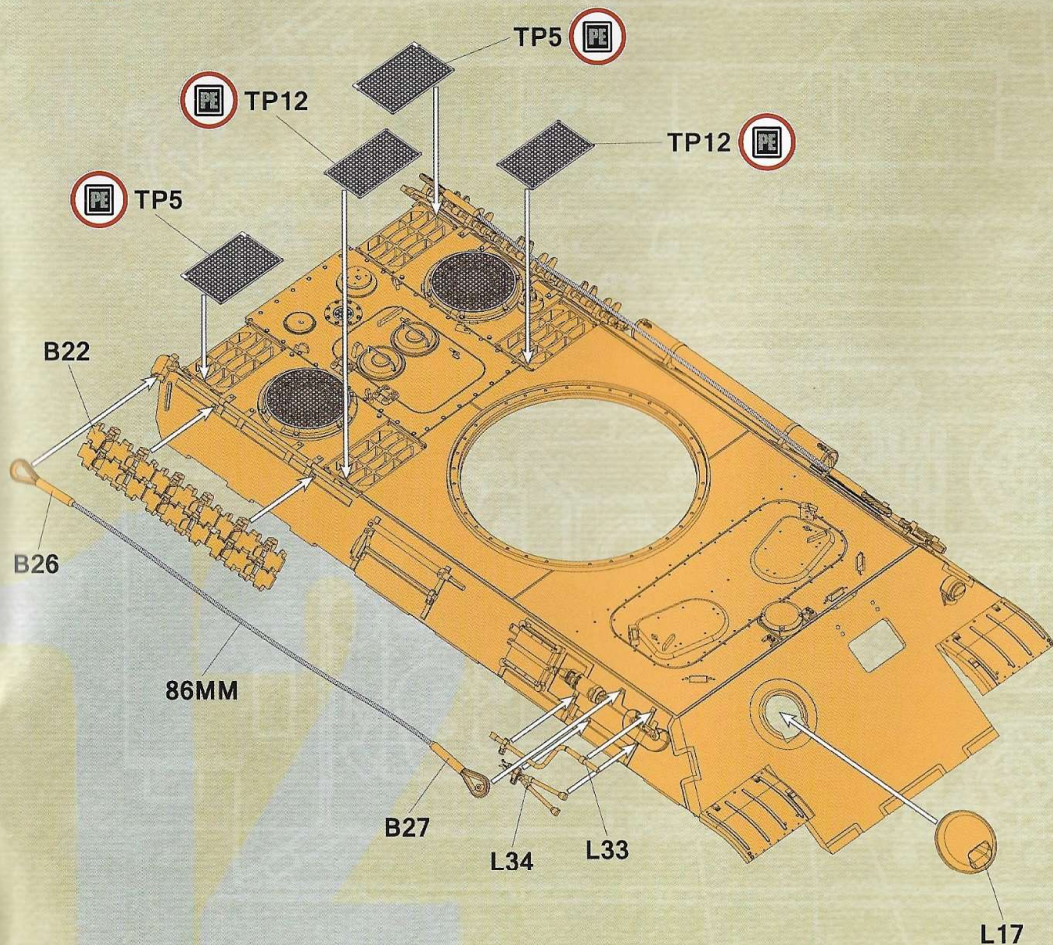

24

机枪安装

Attaching machine gun

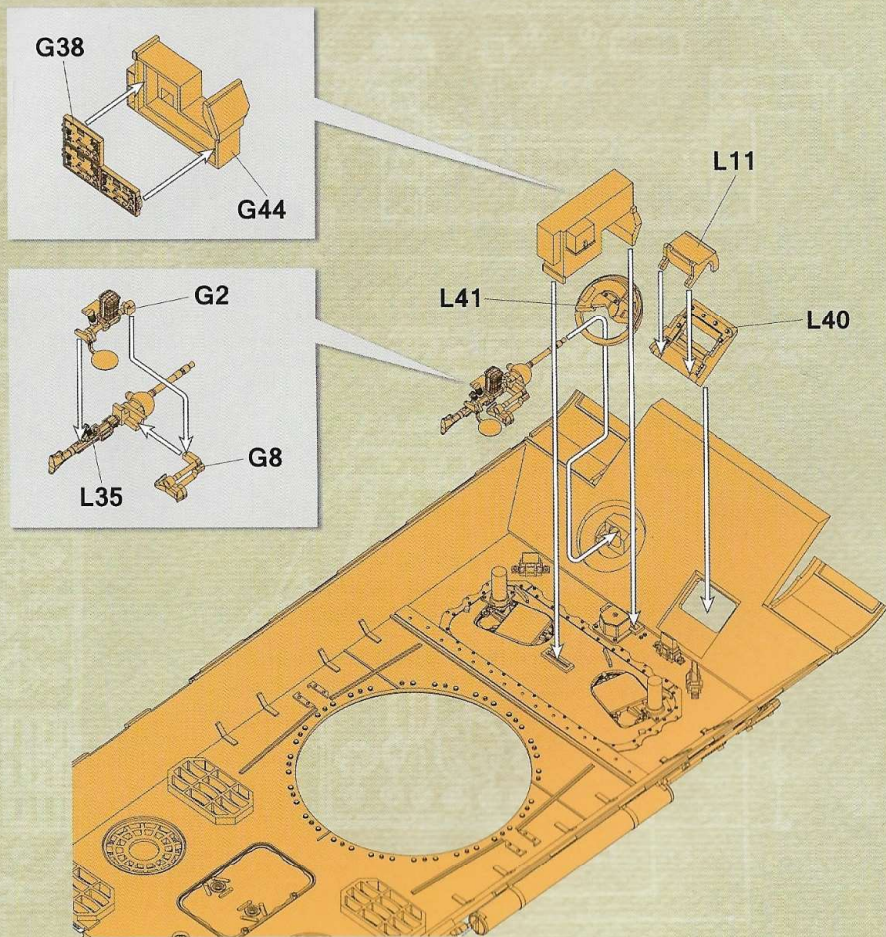

25

车体组装 5

Hull assembly 5

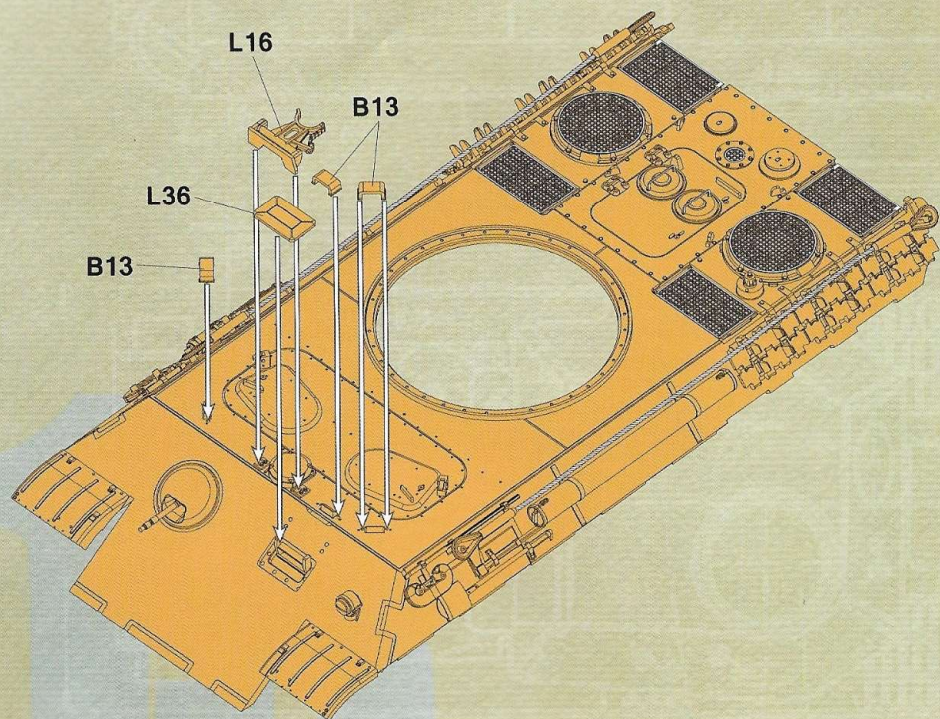

26

车体组装 6

Hull assembly 6

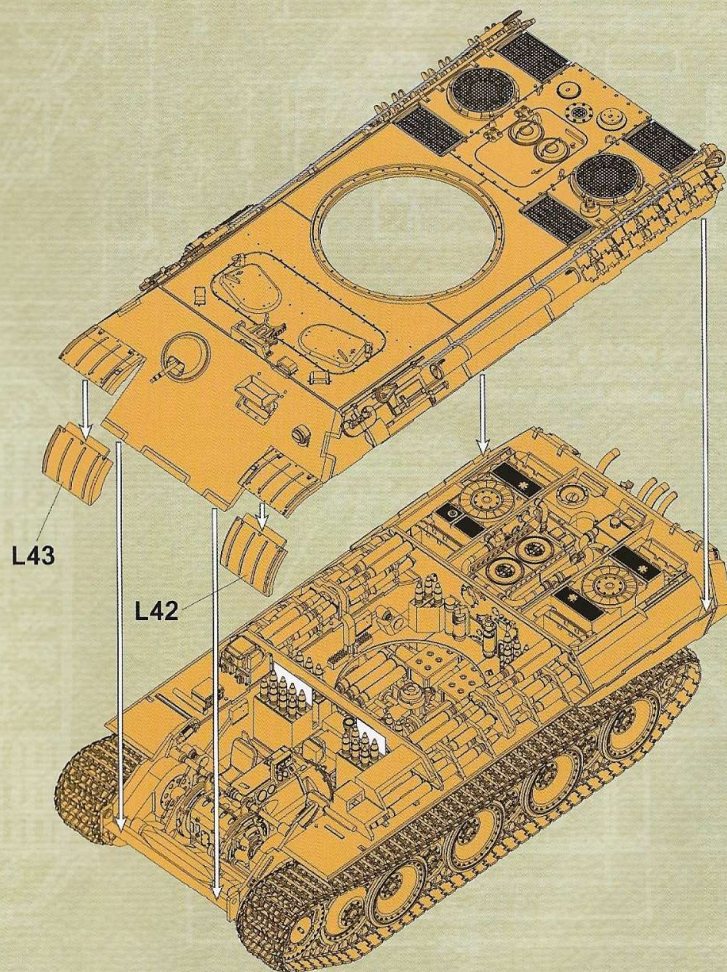

27

裙板安裝



Attaching side skirts

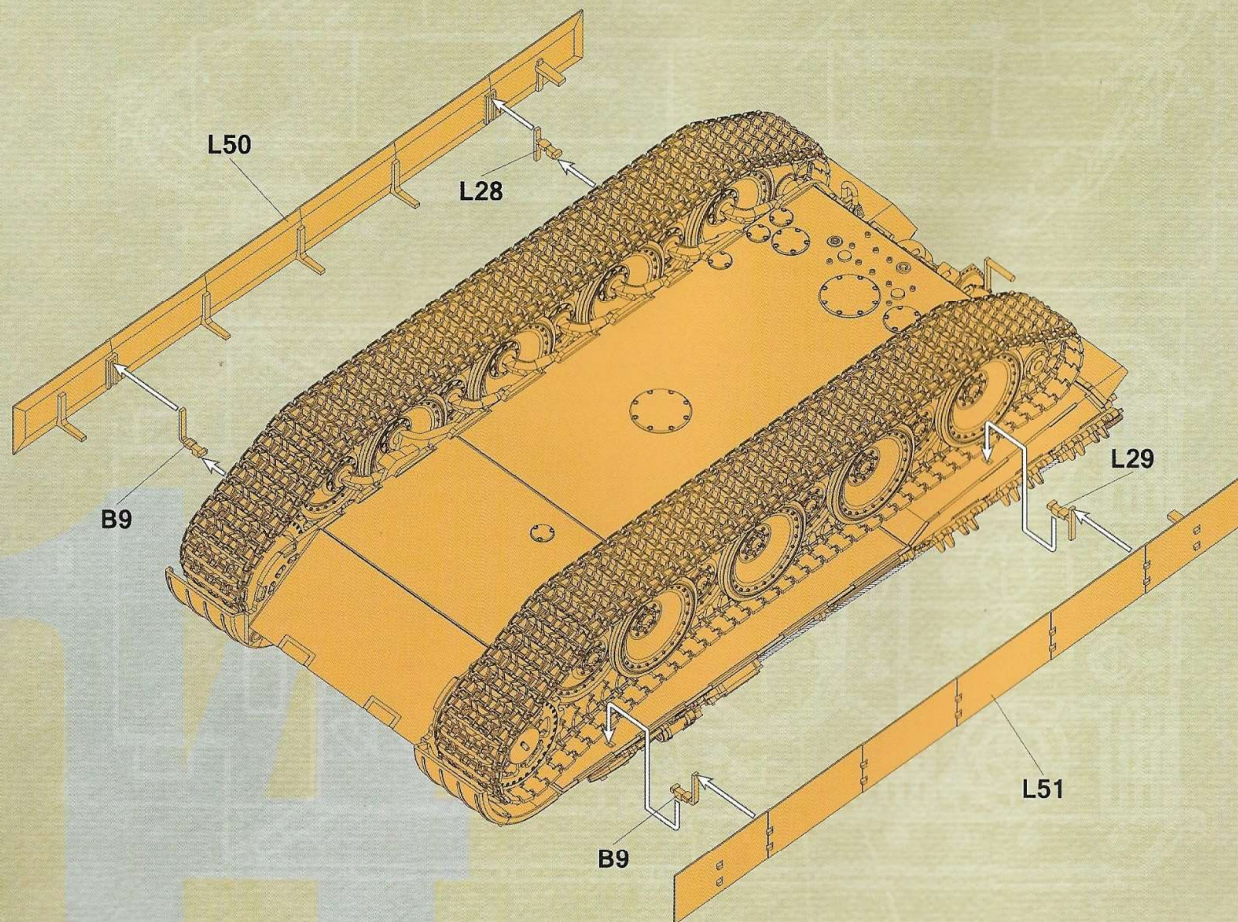

28

炮塔組裝 1



Turret assembly 1

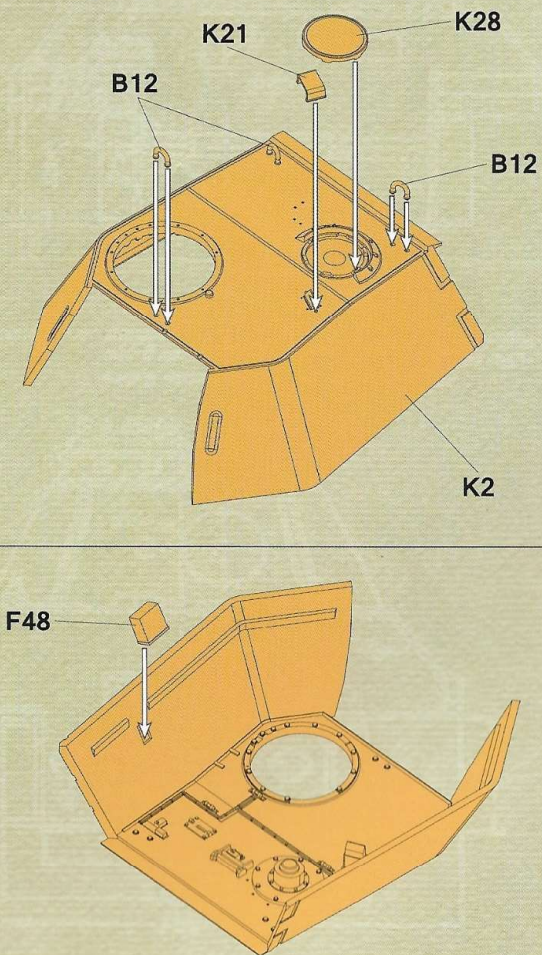

29

炮塔组装 2



Turret assembly 2

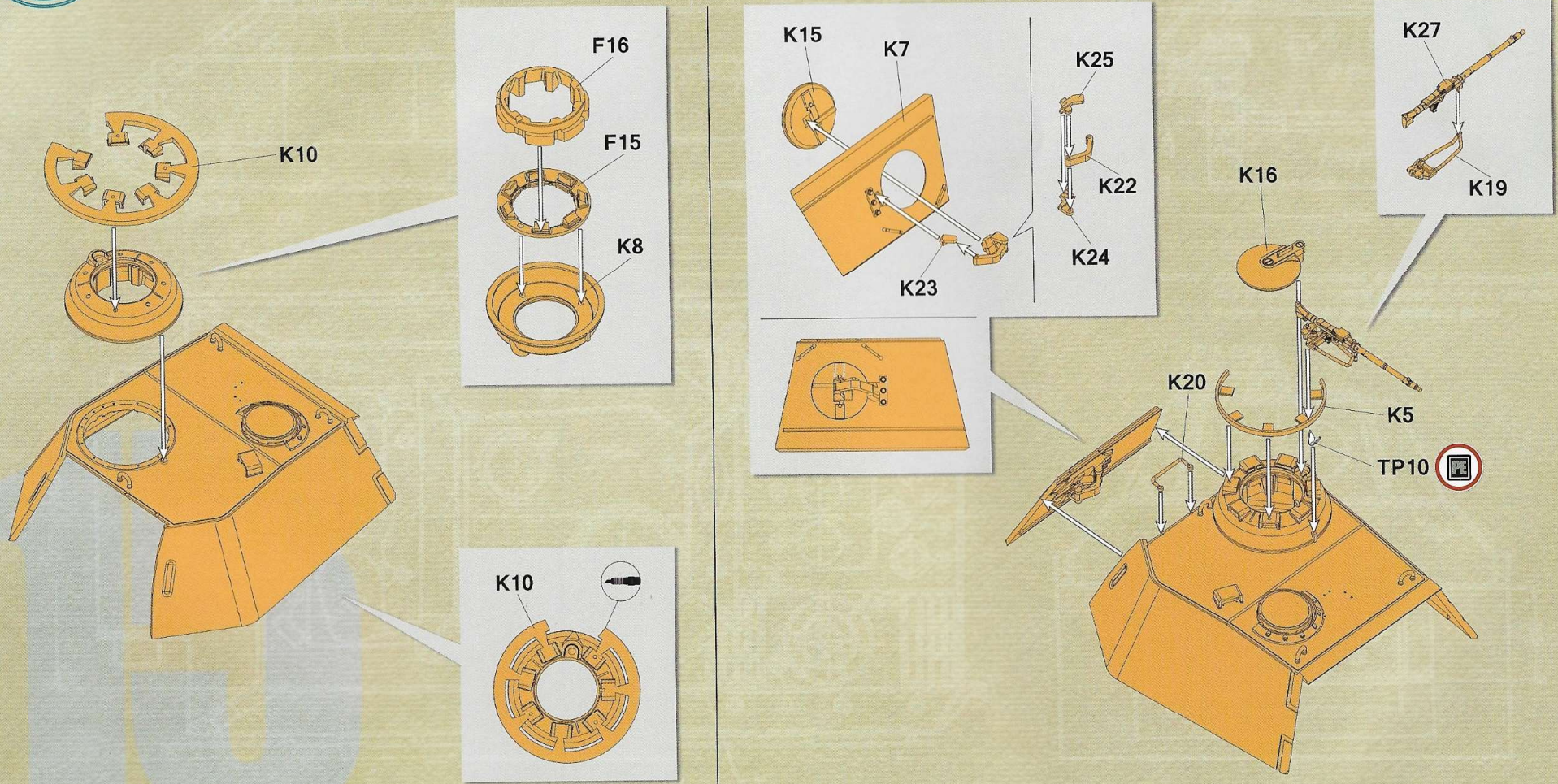

30

炮塔组装 3

Turret assembly 3

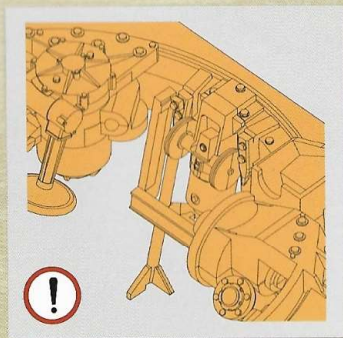
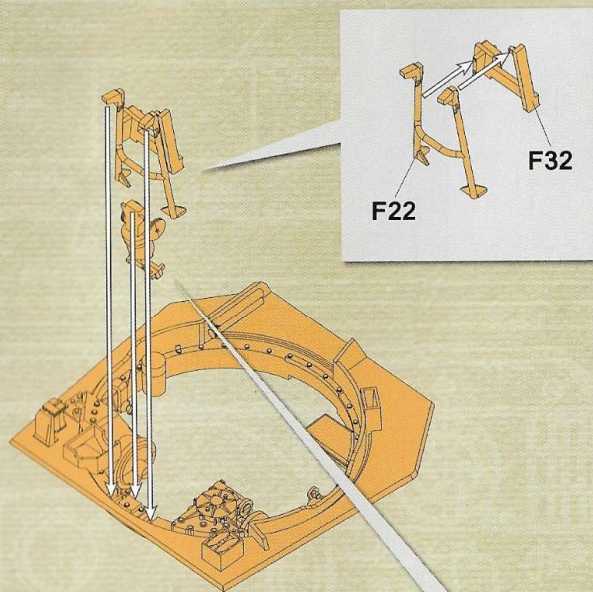
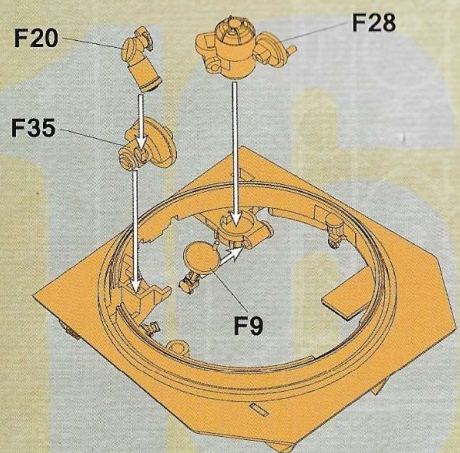
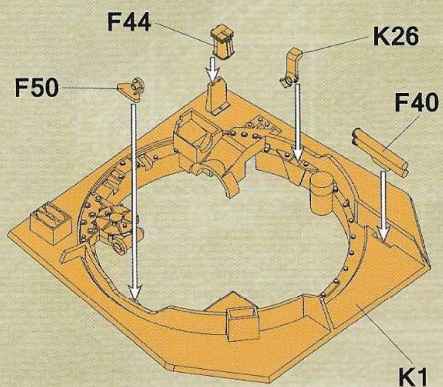

31

炮塔组装 4

Turret assembly 4

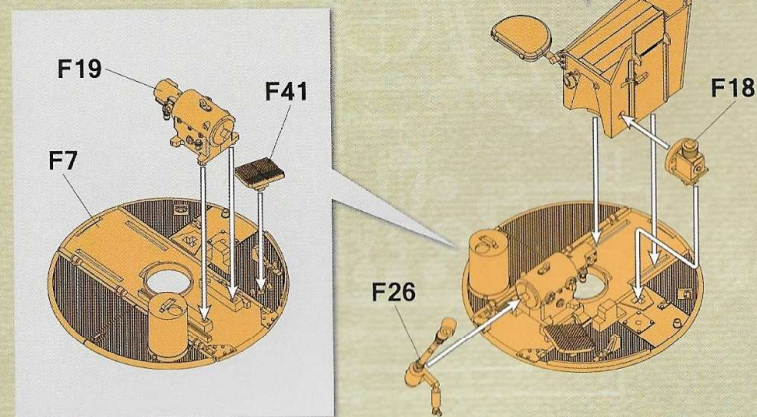
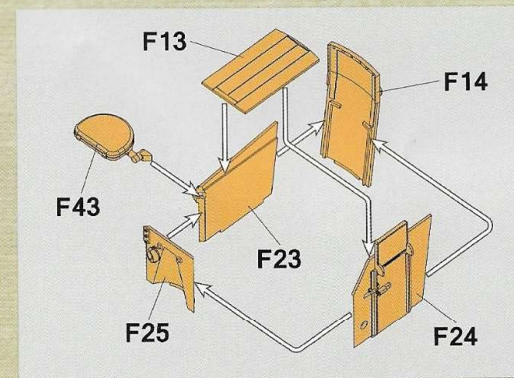

32

炮塔组装 5



Turret assembly 5

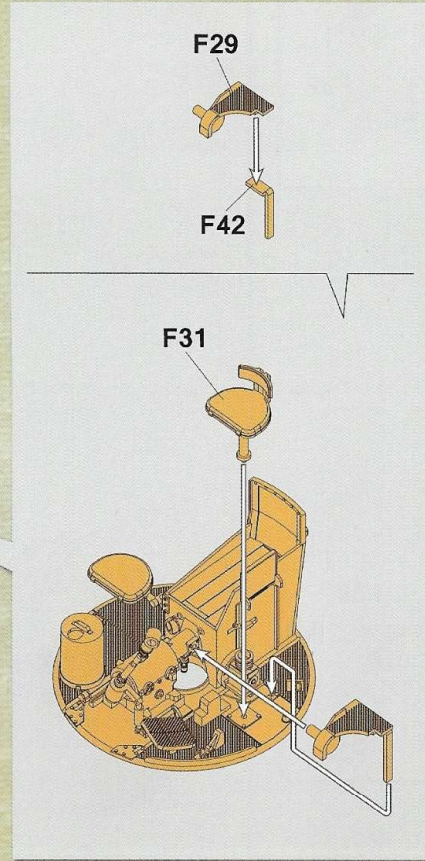
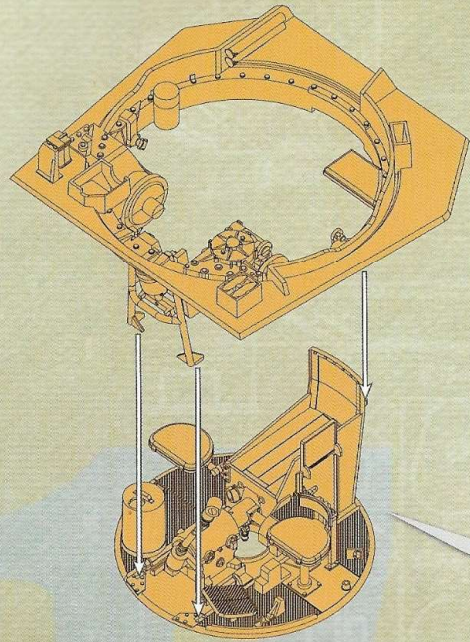

33

火炮组装 1



Gun assembly 1

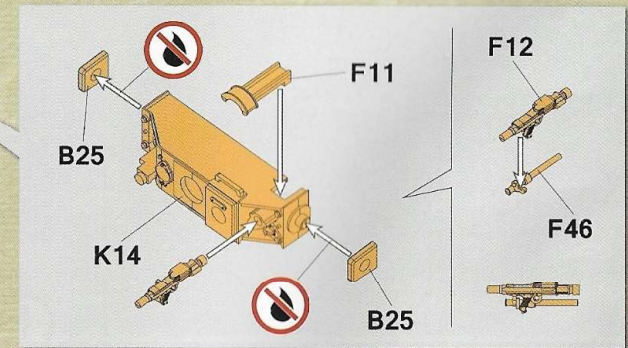
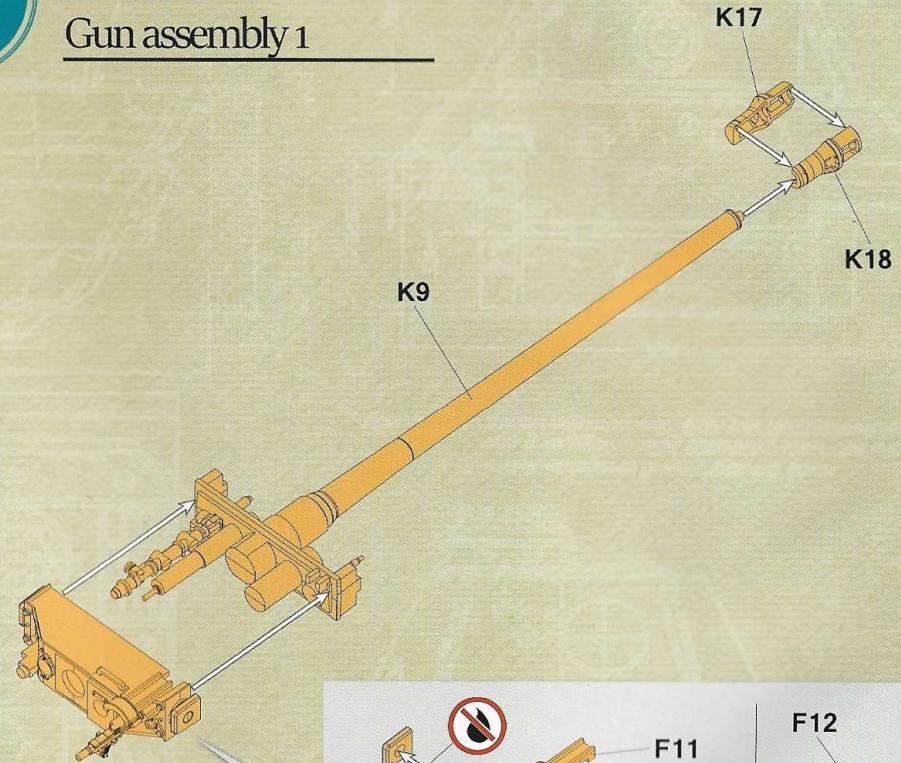

34

火炮组装 2



Gun assembly 2

35

火炮组装 3



Gun assembly 3

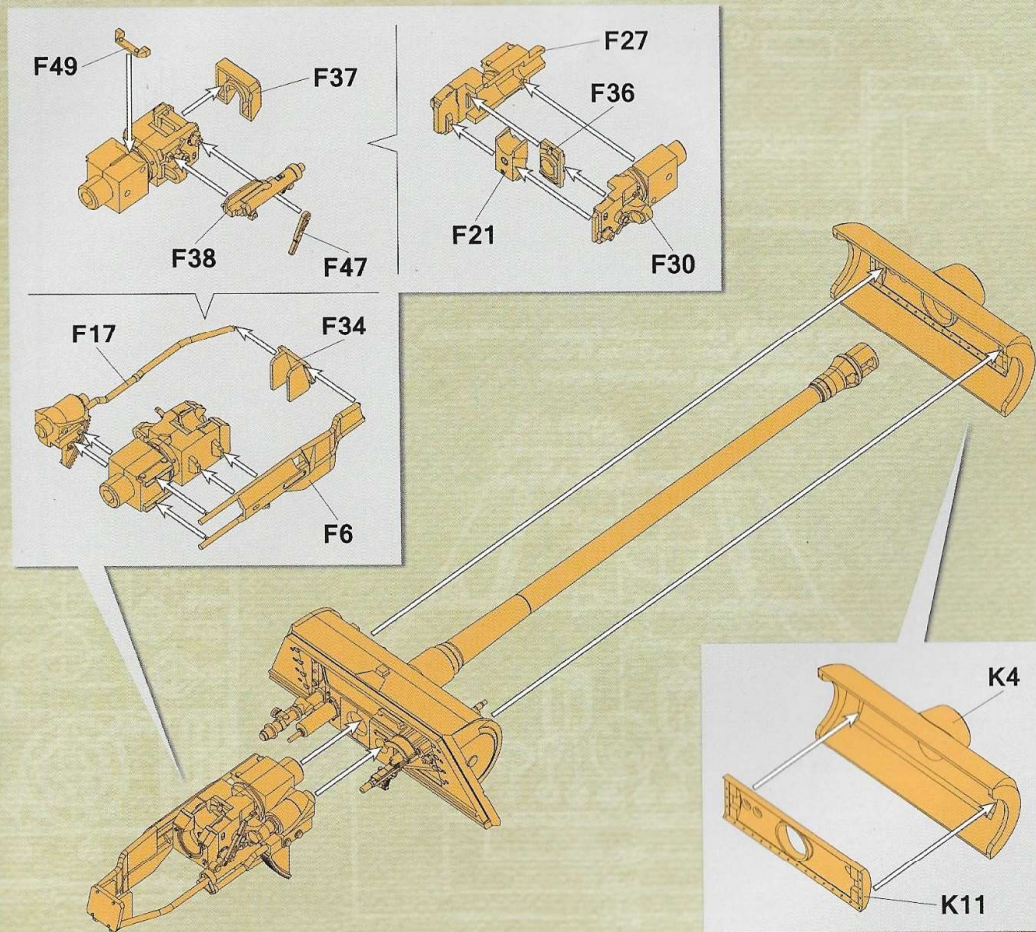
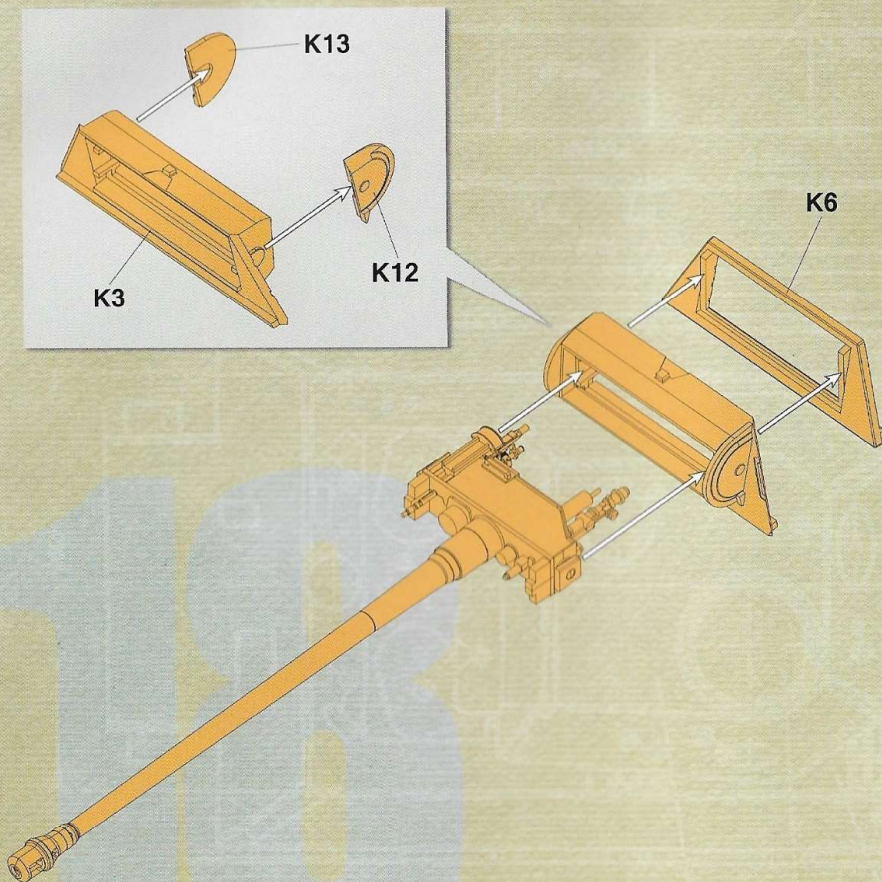

36

火炮组装 4



Gun assembly 4

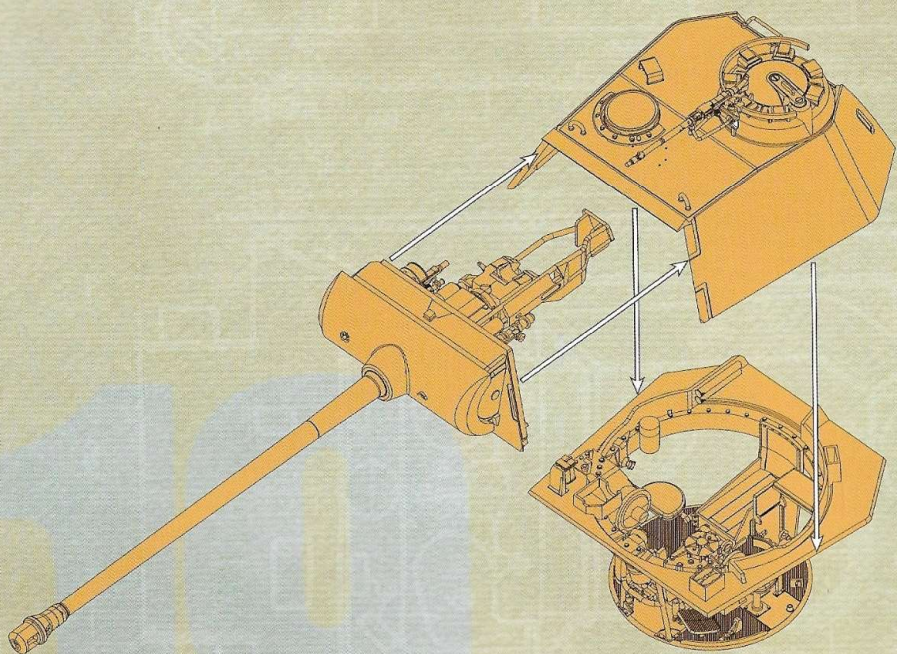

37

炮塔安装



Attaching turret

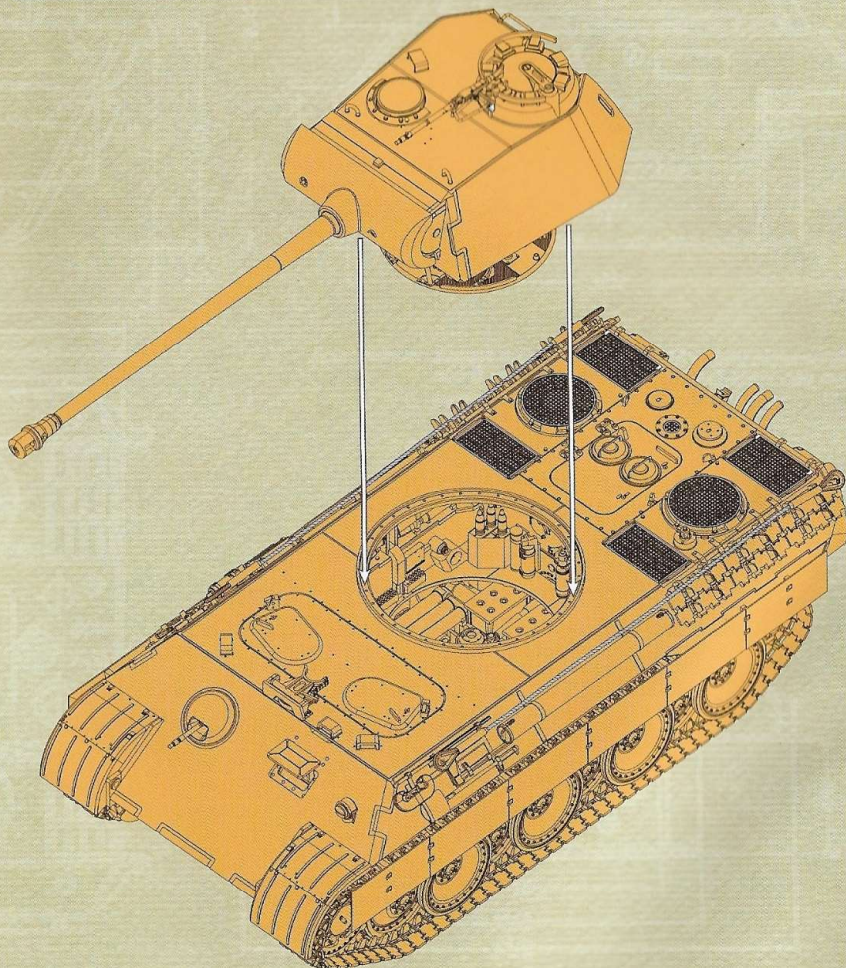

SUYATA

38

吊车组装 1



Gantry crane assembly 1

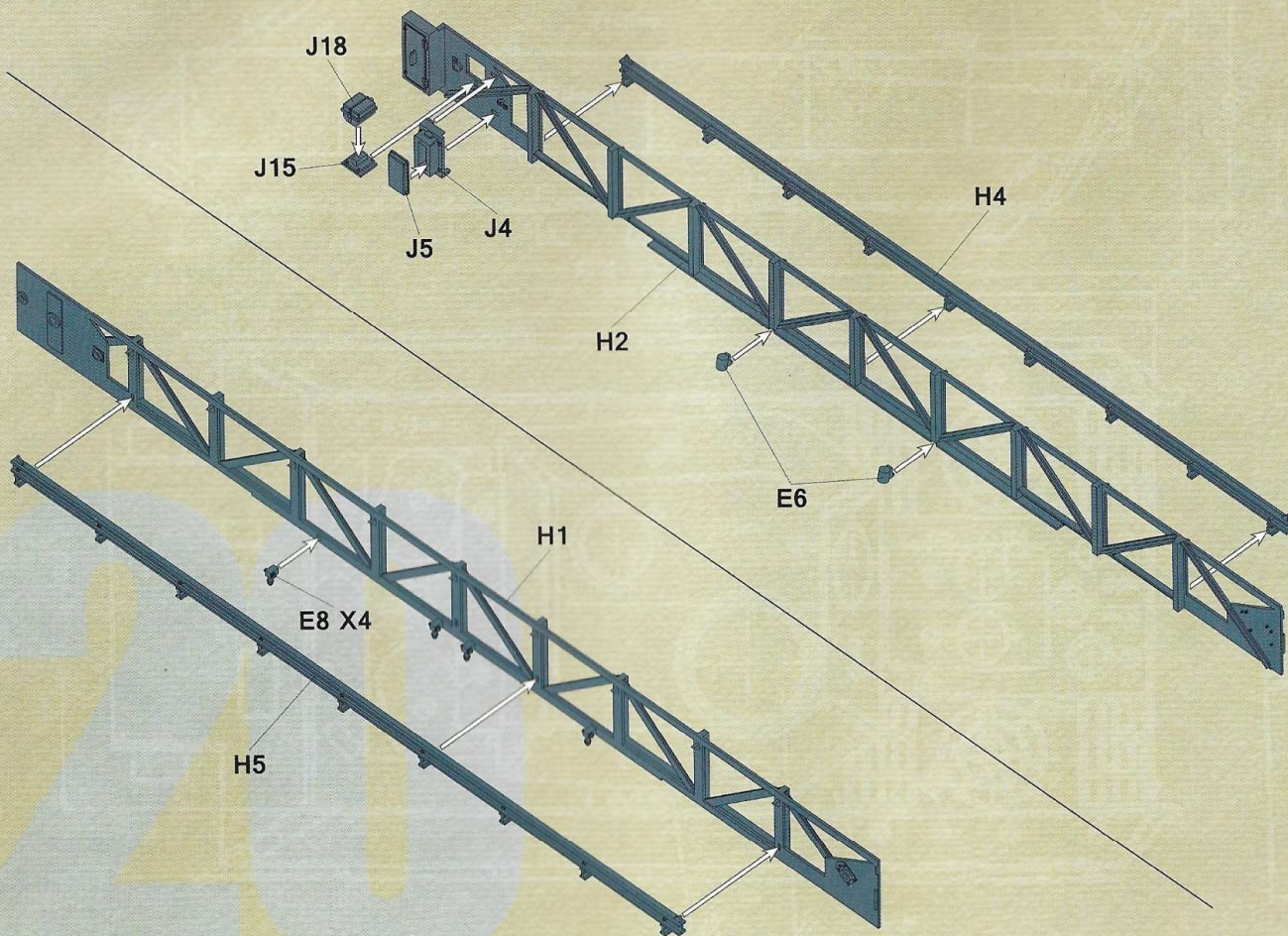

39

吊车组装 2



Gantry crane assembly 2

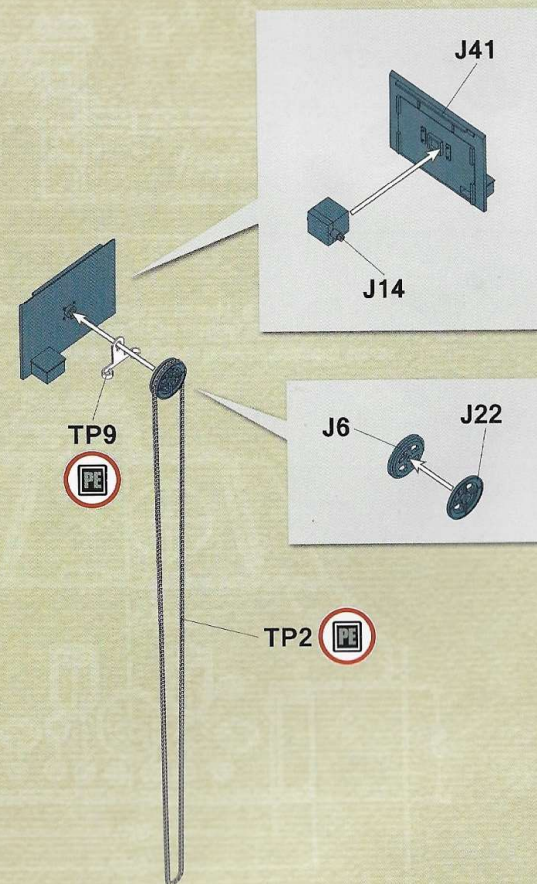

40

吊车组装 3



Gantry crane assembly 3

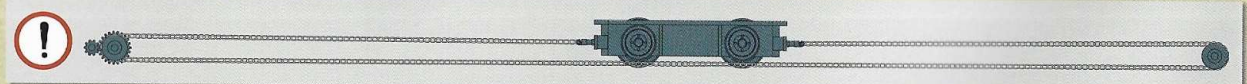
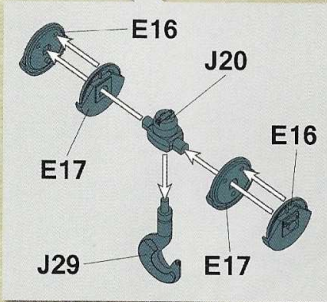
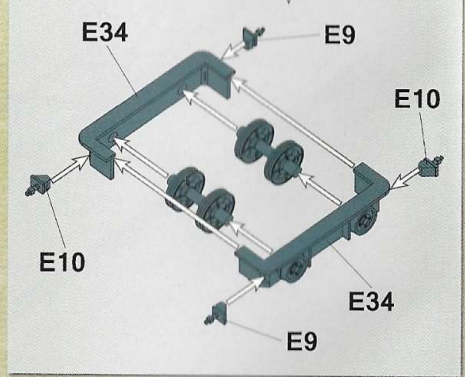
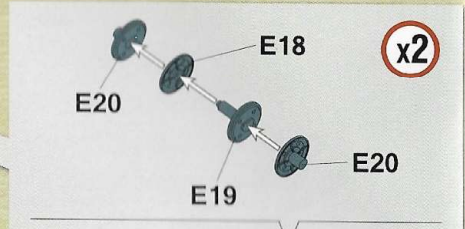
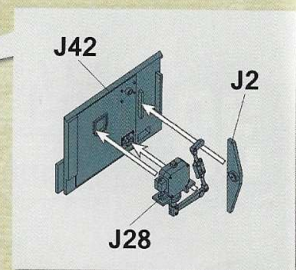
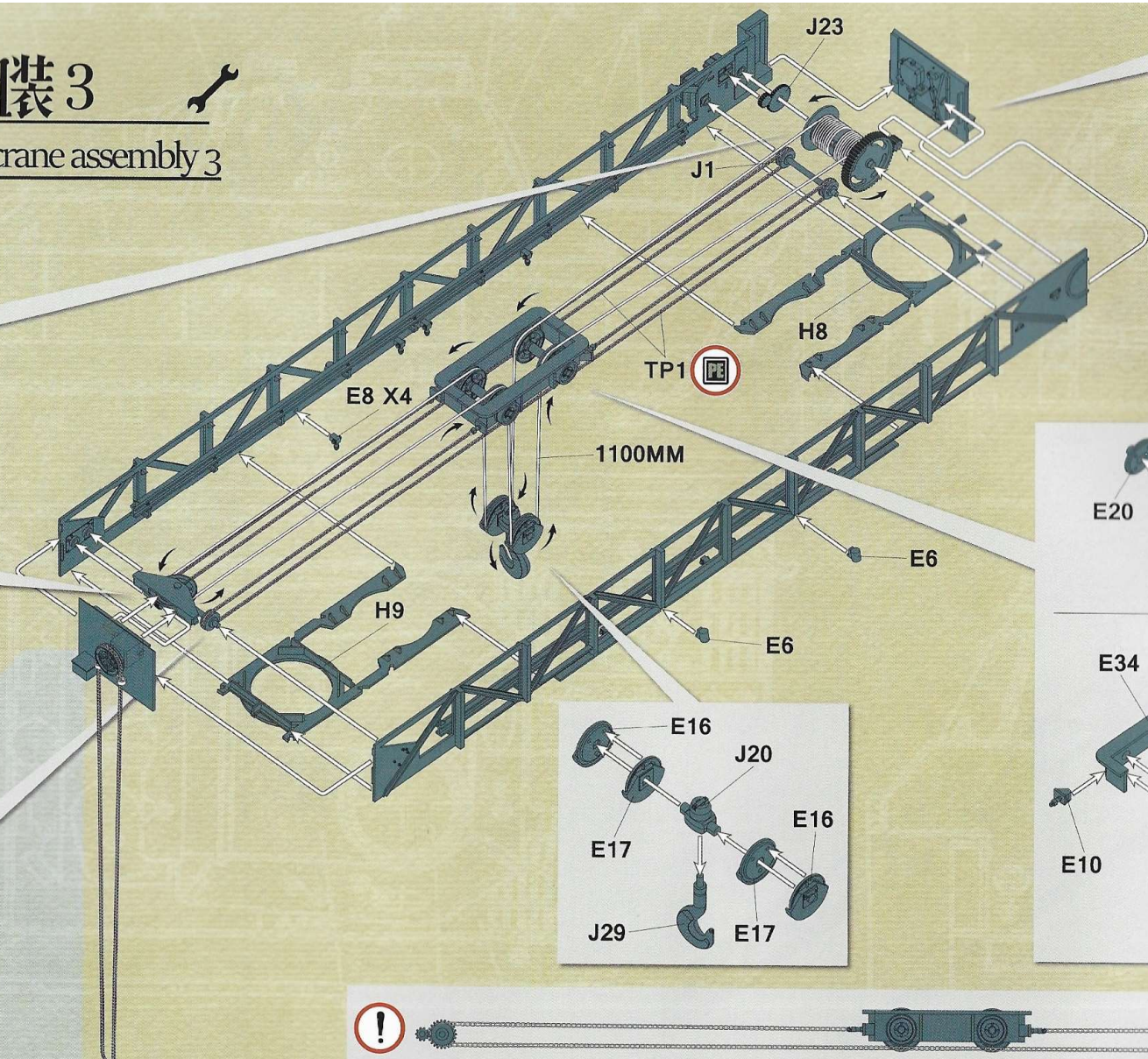
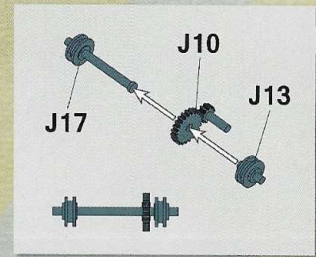
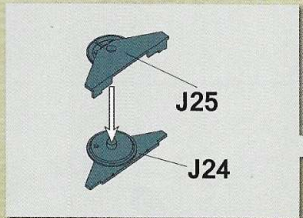
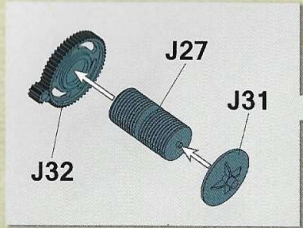

SUYATA

41

吊车组装 4



Gantry crane assembly 4

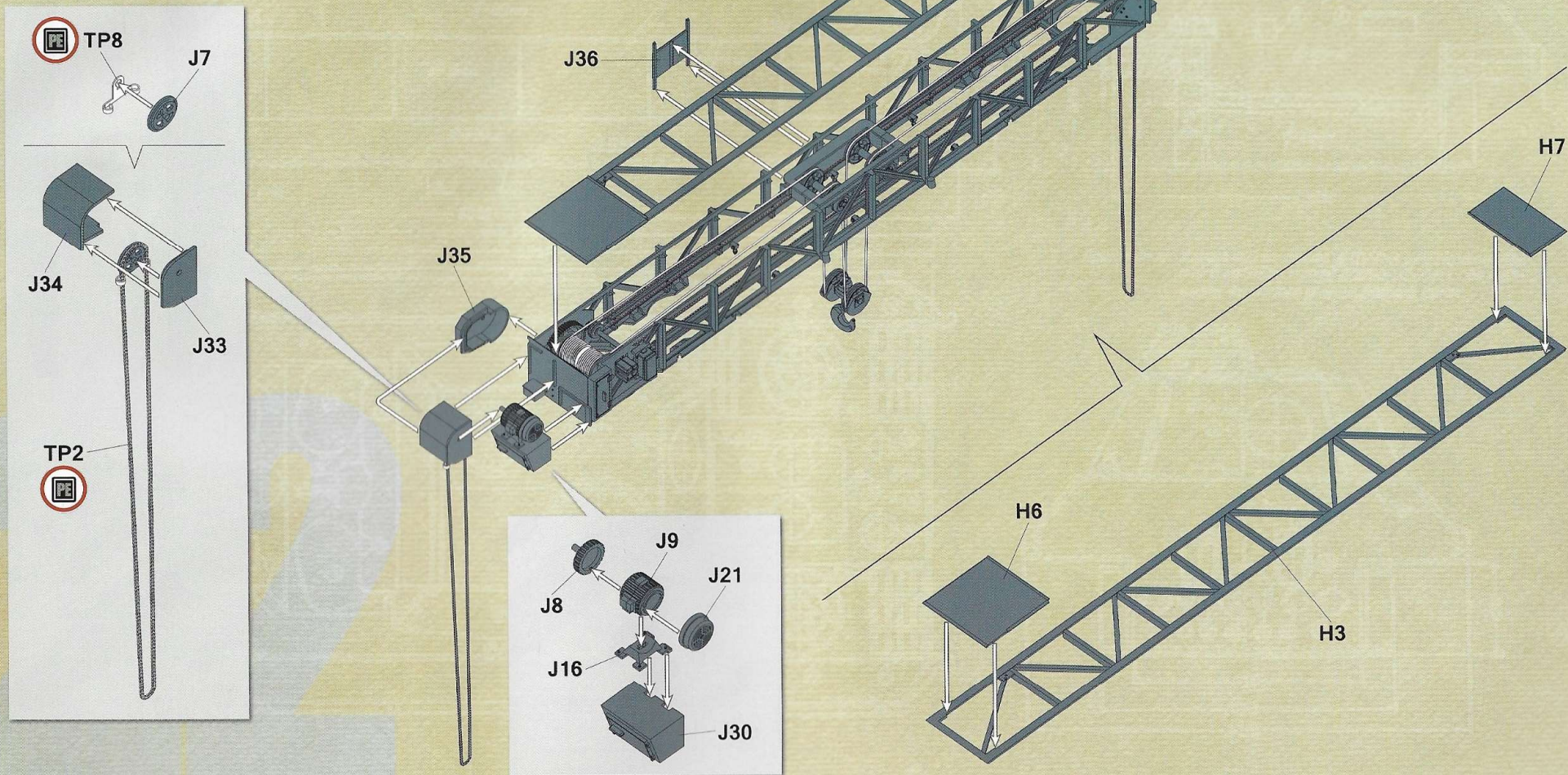

42

吊车组装 5



Gantry crane assembly 5

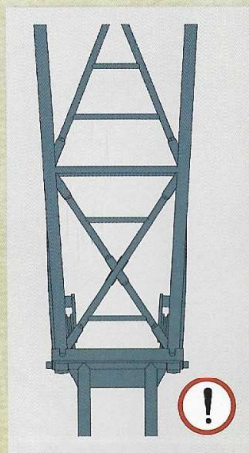
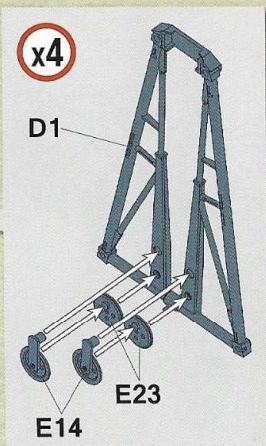
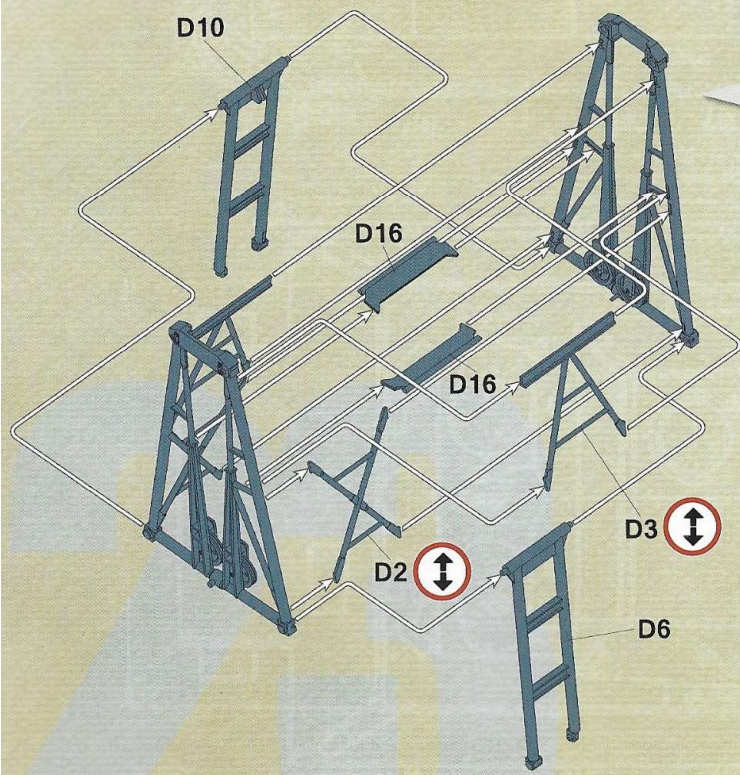

43

吊车组装 6



Gantry crane assembly 6

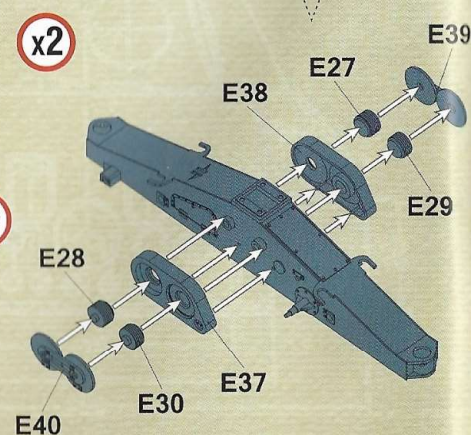
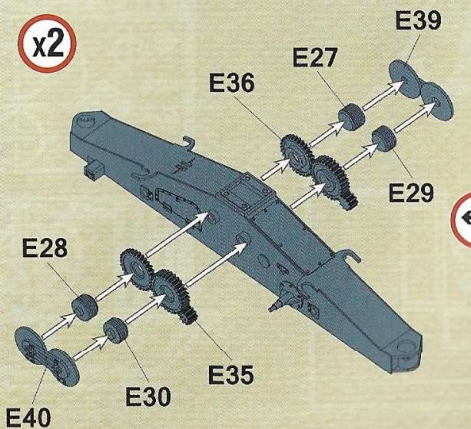
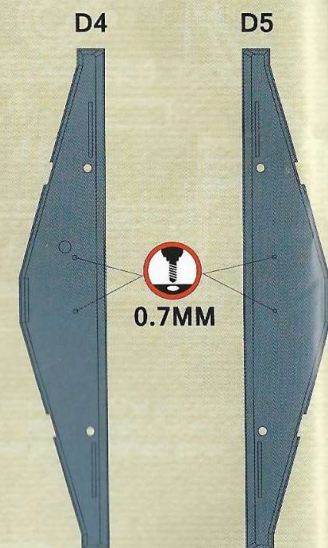
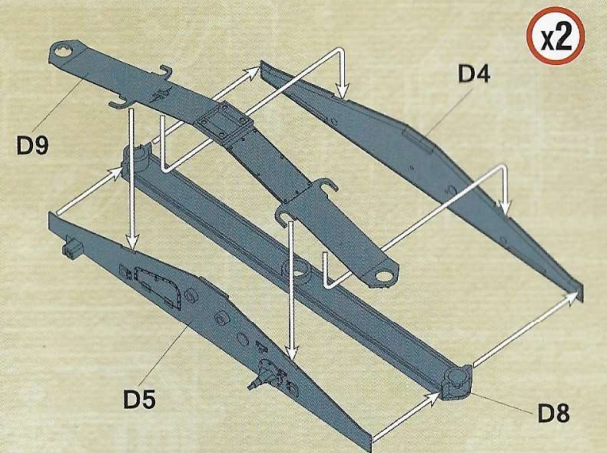

44

吊车组装 7



Gantry crane assembly 7

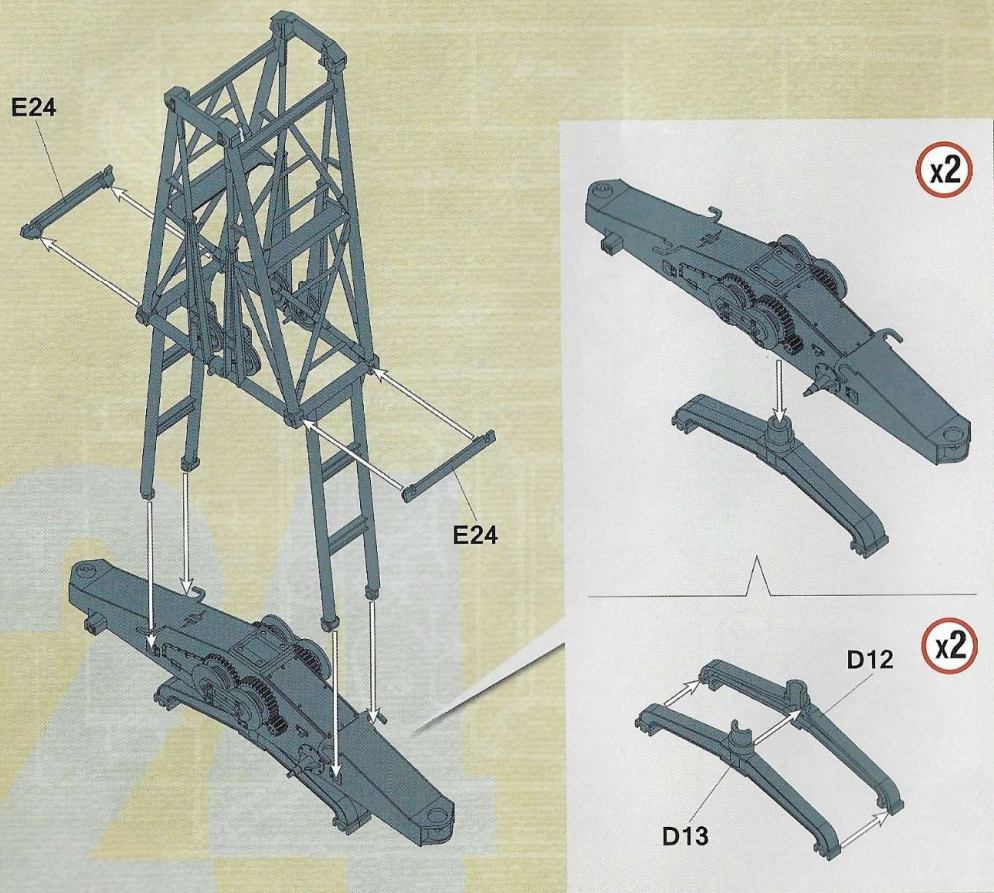

45

吊车组装 8



Gantry crane assembly 8

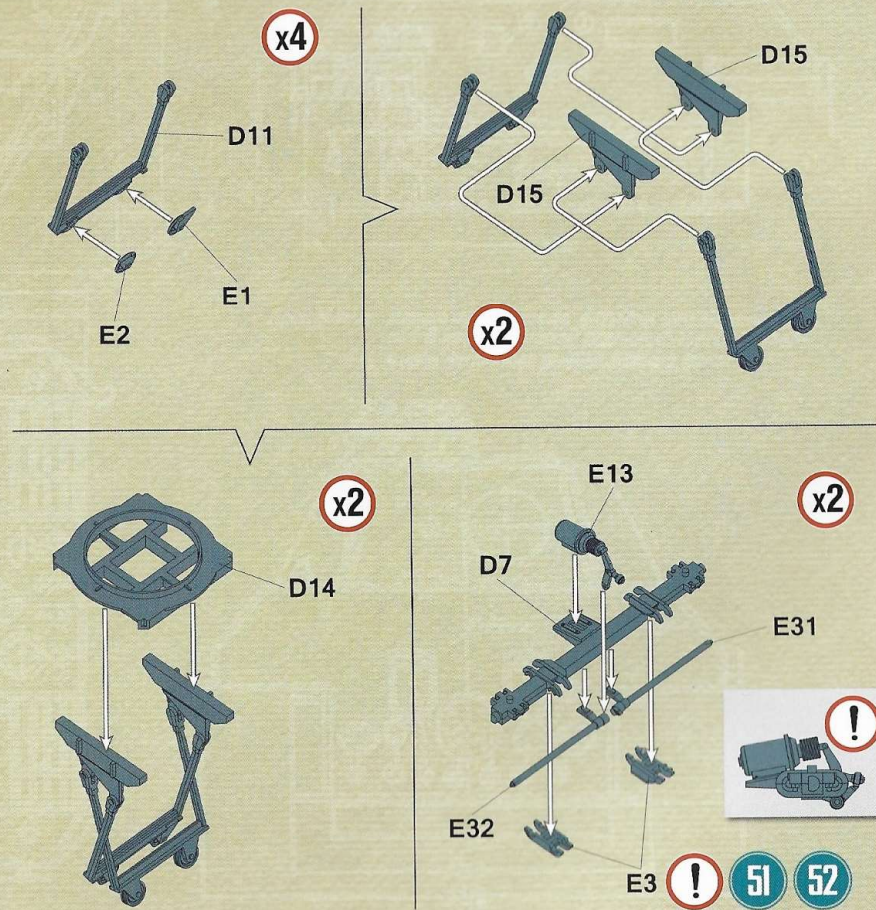

46

吊车组装 9



Gantry crane assembly 9

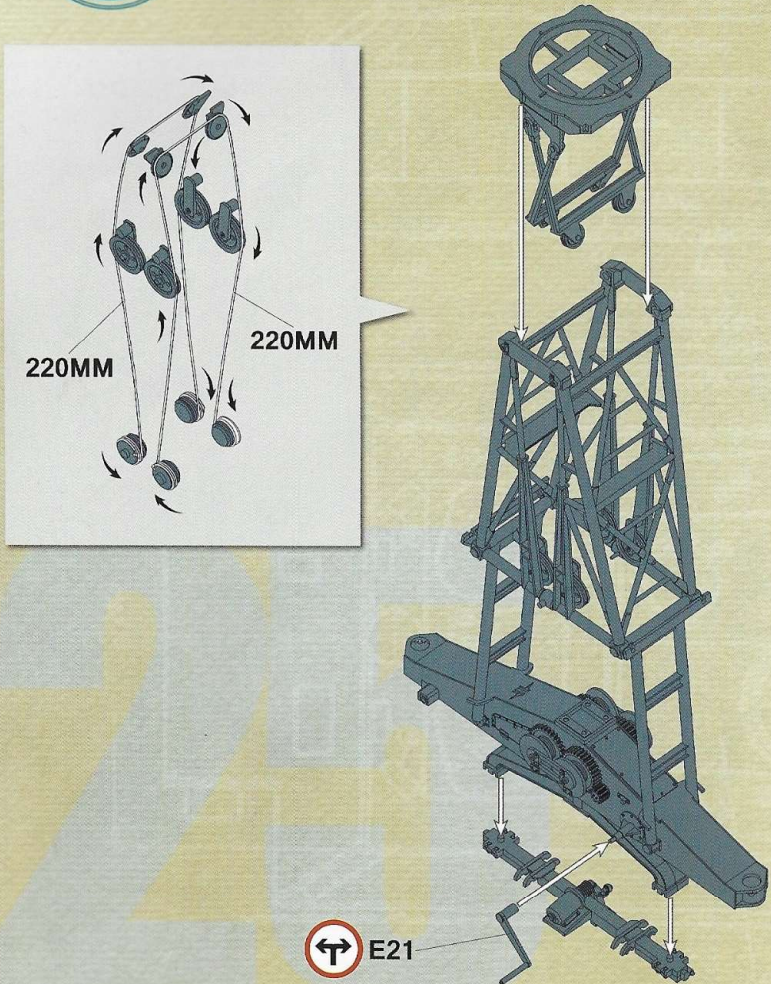

47

吊车组装 10



Gantry crane assembly 10

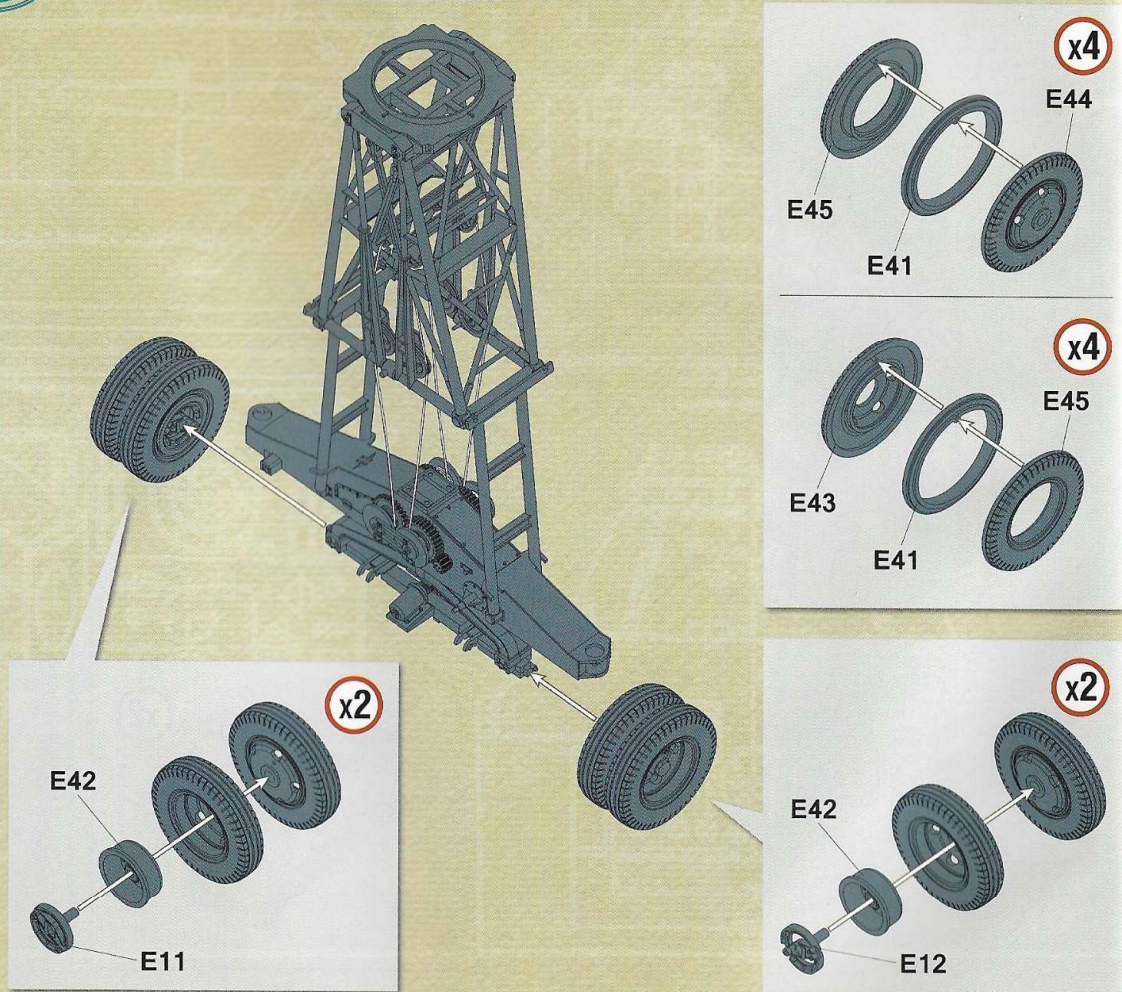

48

吊车组装 11



Gantry crane assembly 11

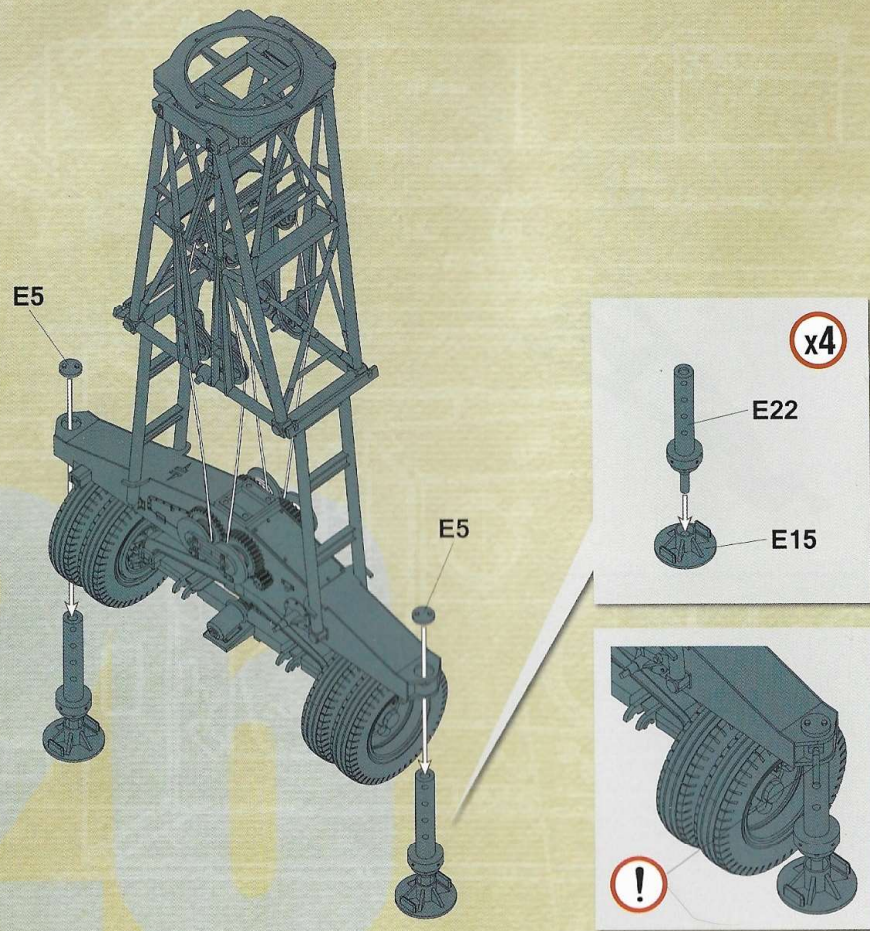

49

吊车组装 12



Gantry crane assembly 12

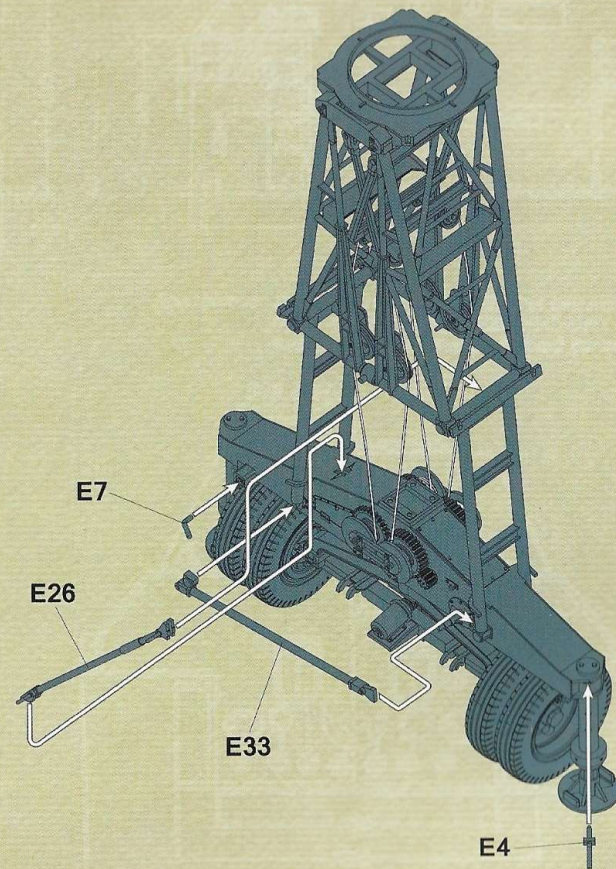

50

吊车组装 13



Gantry crane assembly 13

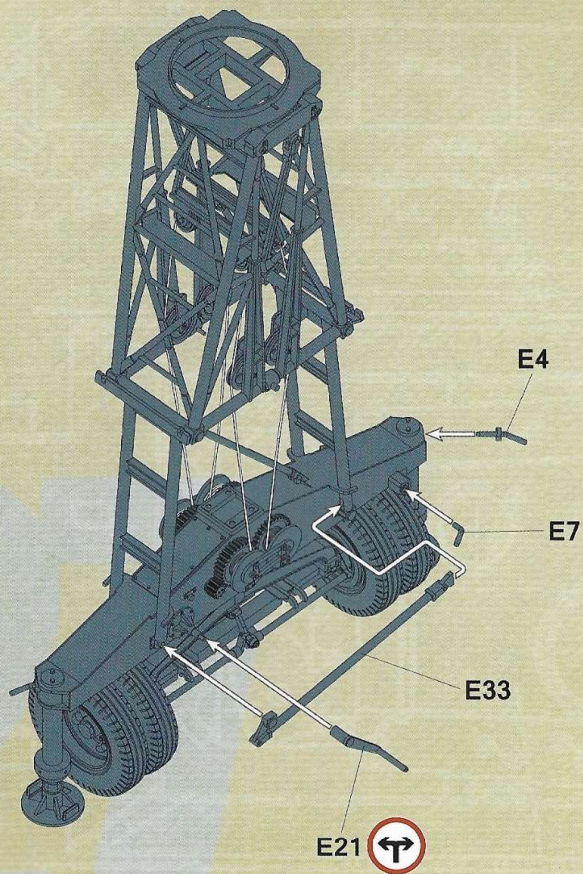

51

吊车组装 14



Gantry crane assembly 14

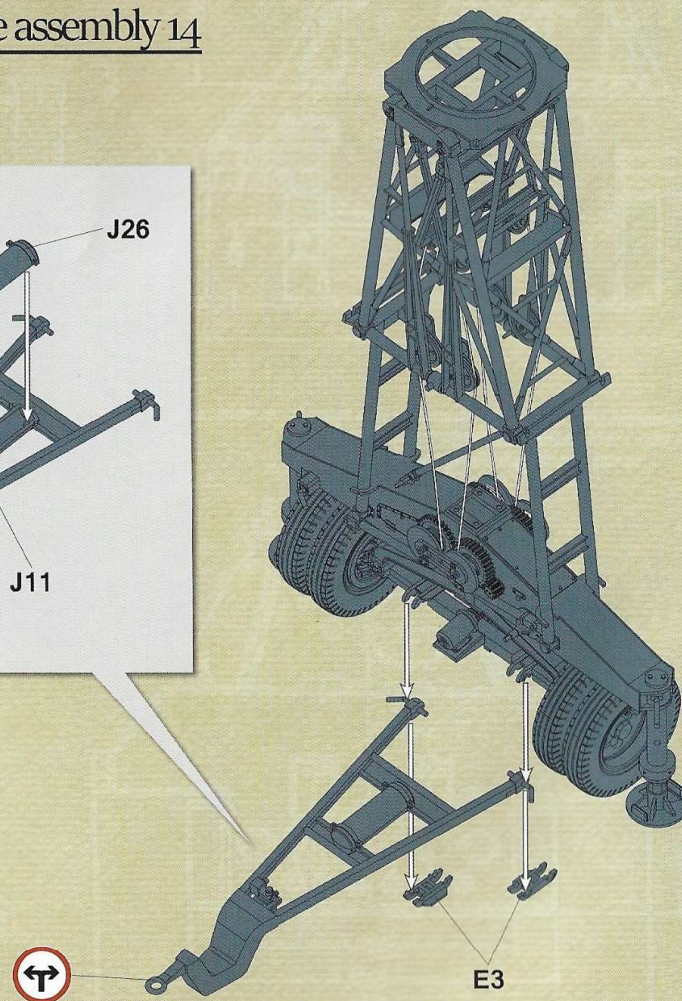
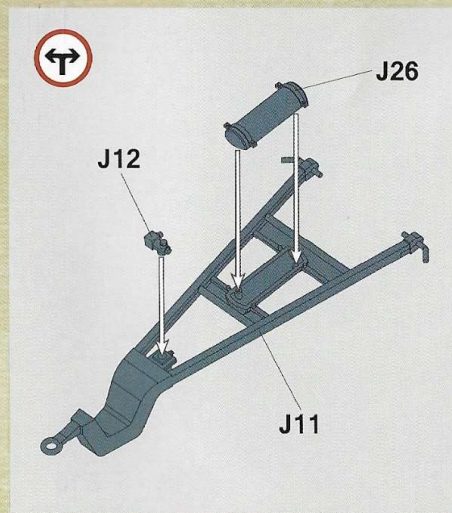

52

吊车组装 15



Gantry crane assembly 15

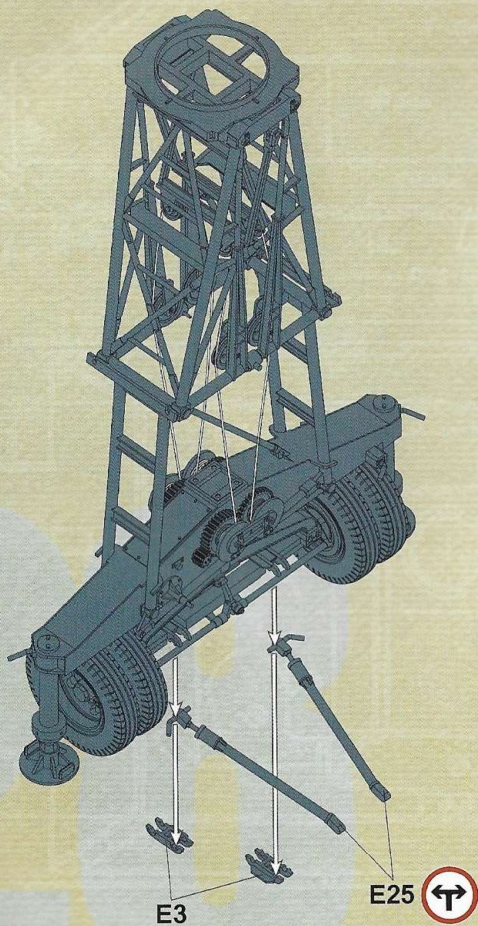

53

吊车组装 16



Gantry crane assembly 16

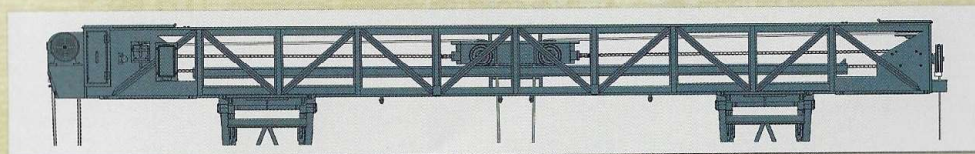
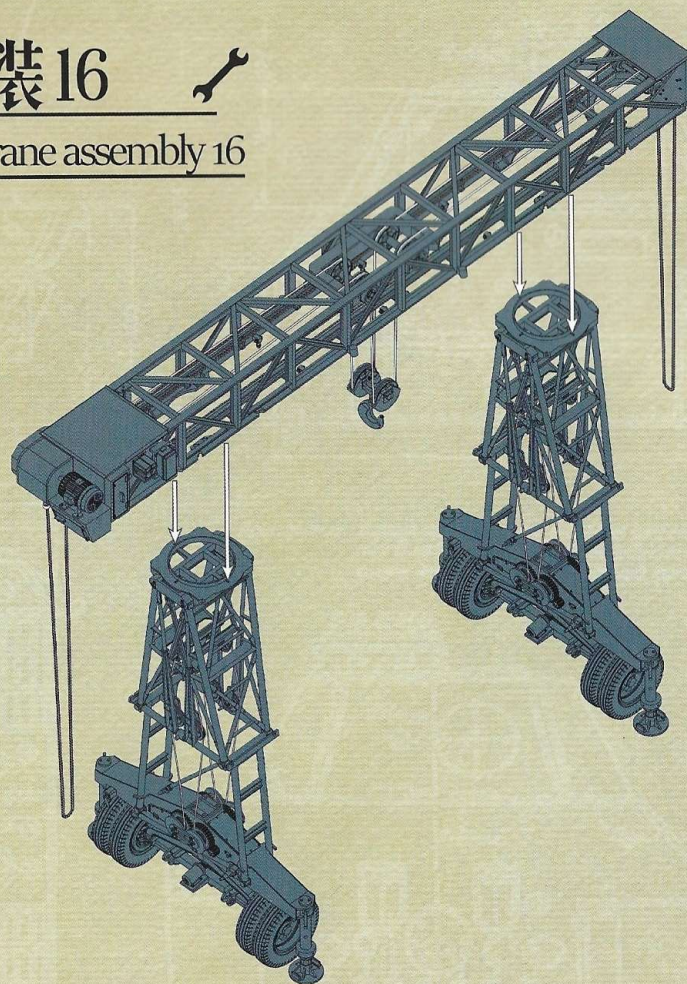

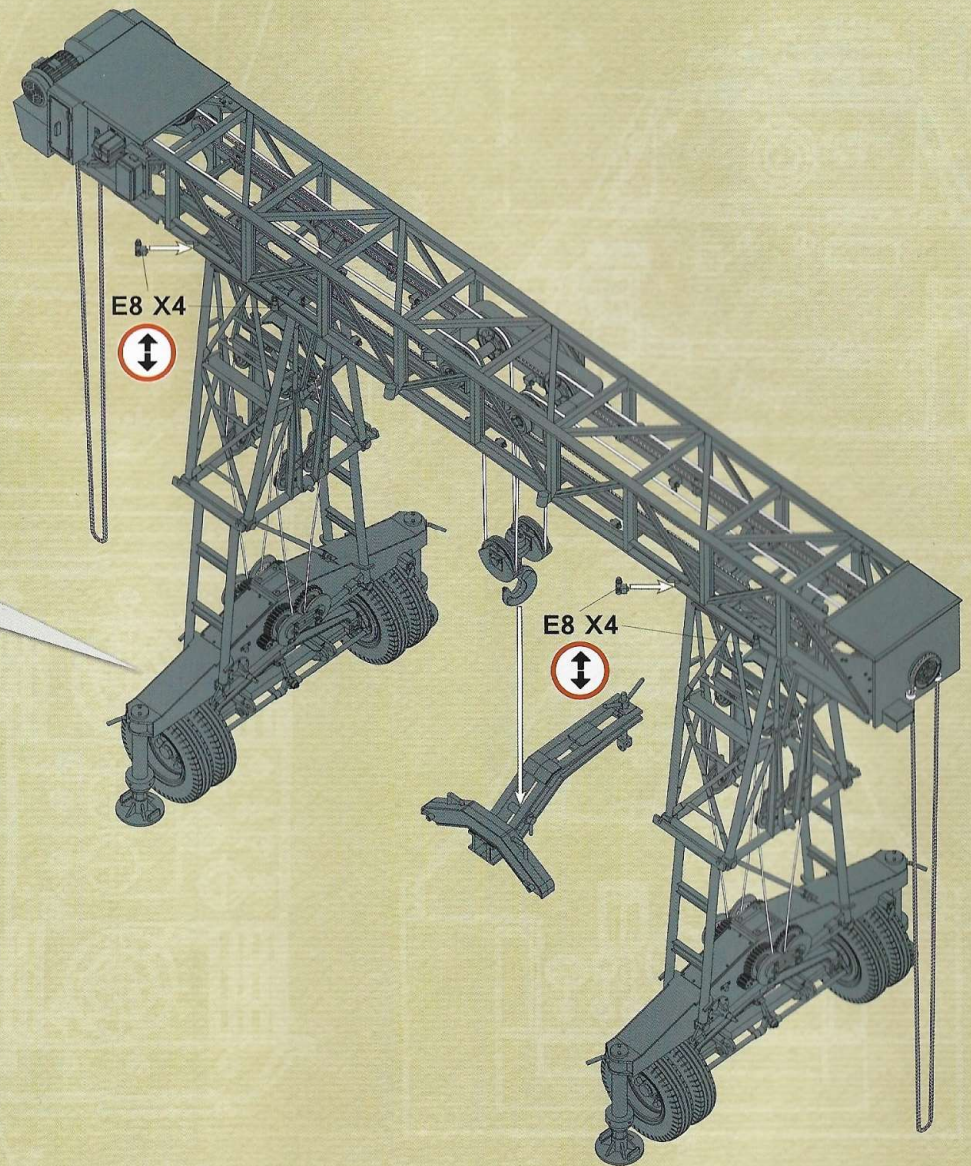
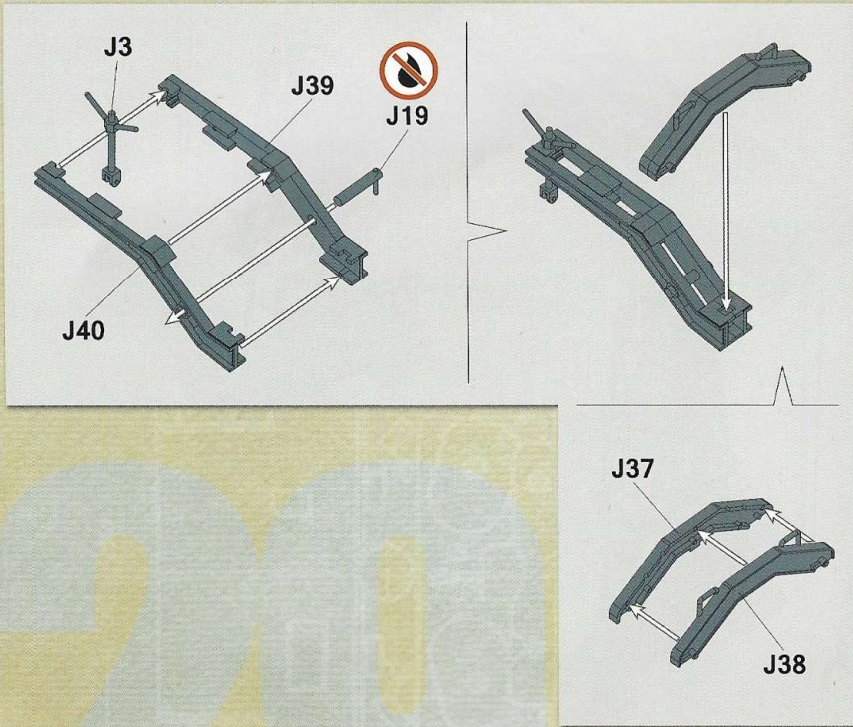

55

维修情景组装 1

Diorama assembly 1

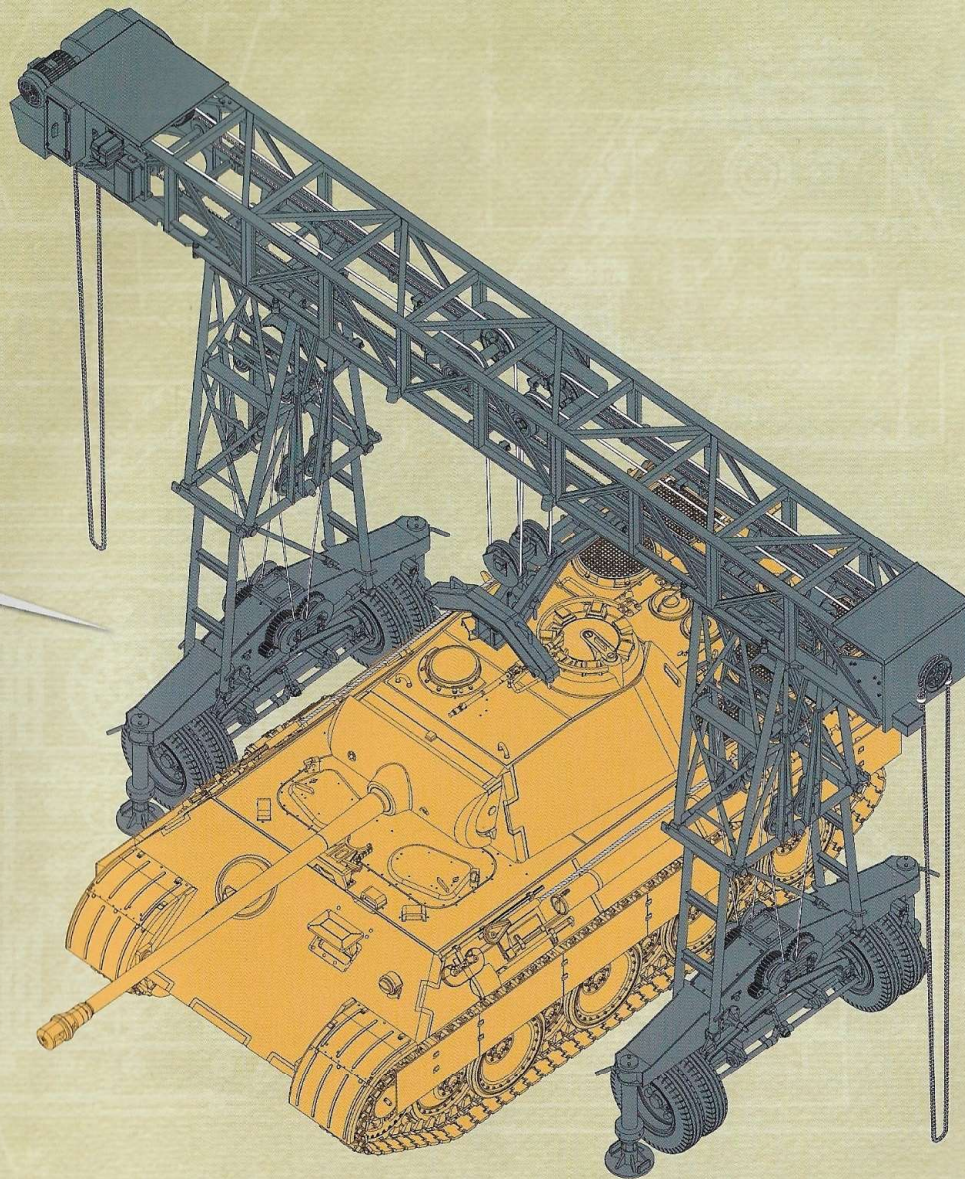
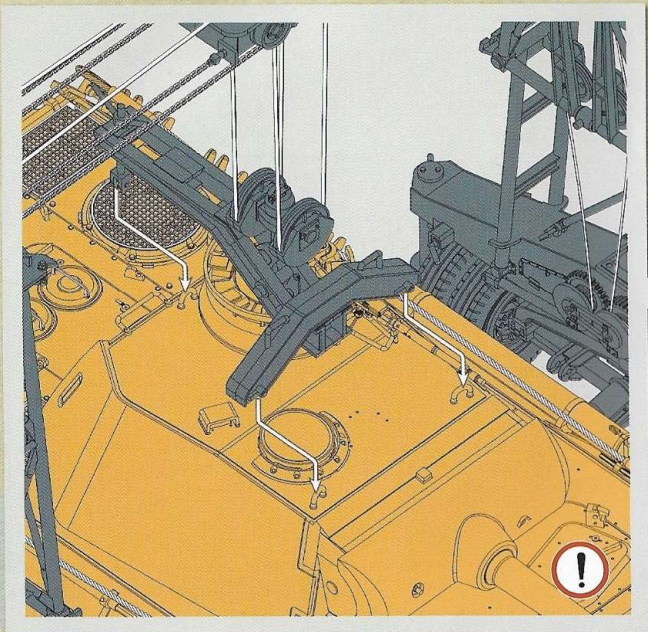

SUYATA

56

维修情景组装 2

Diorama assembly 2

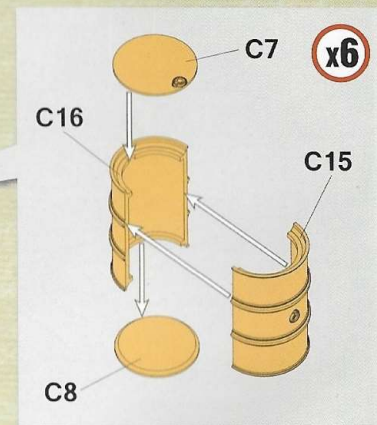
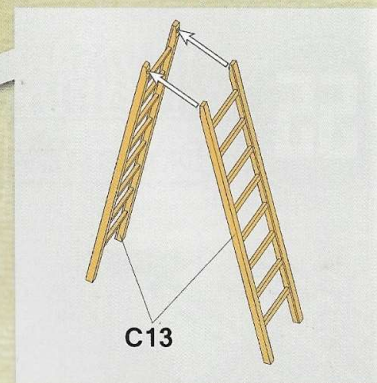
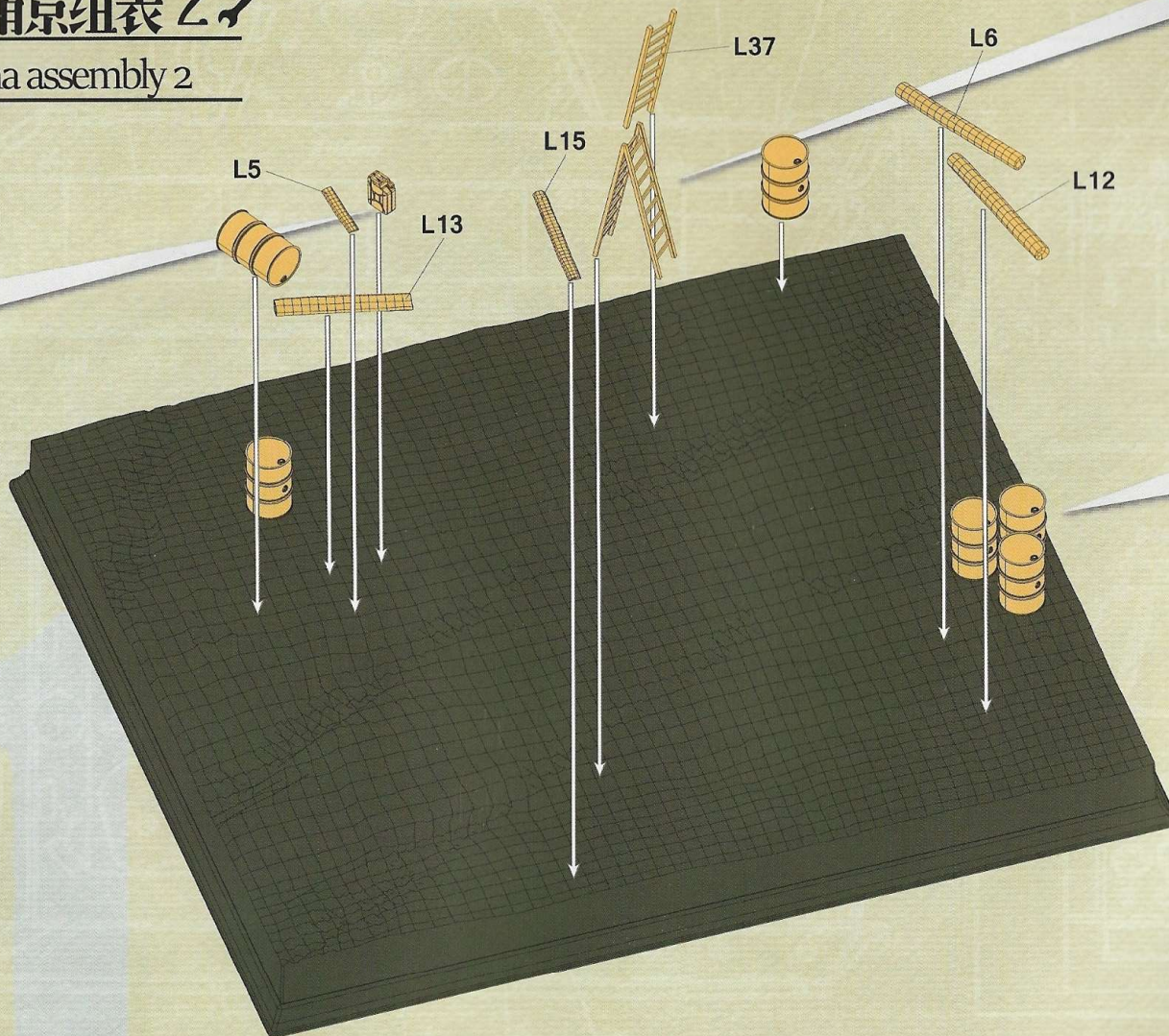
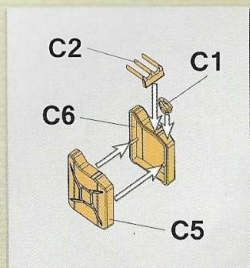

SUYATA

57

维修情景安装



Assembling diorama

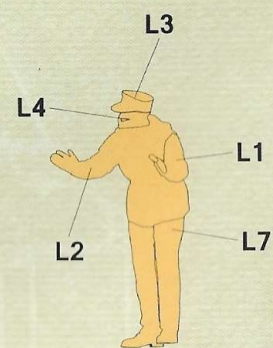
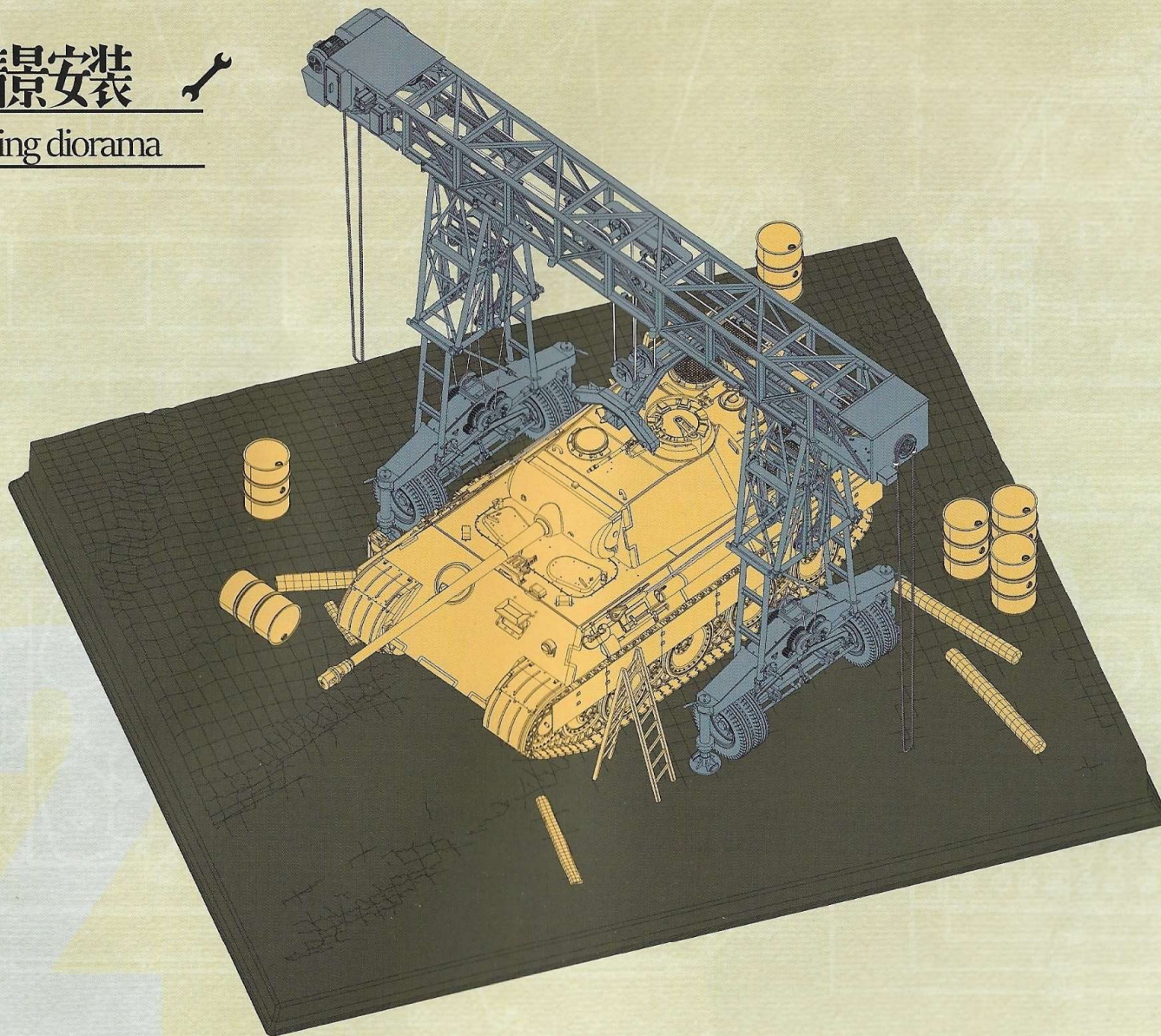

SUYATA

Painting & Marking Guide

Exterior Painting

Panther A, 3./SS-Panzer Regiment 1,
France 1944

www.migjimez.com



A.MIG 033	Rubber & Tires	A.MIG 035	Dark Tracks	A.MIG 036	Old Wood	A.MIG 038	Old Wood
A.MIG 040	Medium Rust	A.MIG 045	Gun Metal	A.MIG 093	Crystal Red	A.MIG 096	Crystal Periscope Green
A.MIG 002	Olivgrün Opt.2	A.MIG 010	Dunkelgelb Mid war	A.MIG 015	Schokobraun		

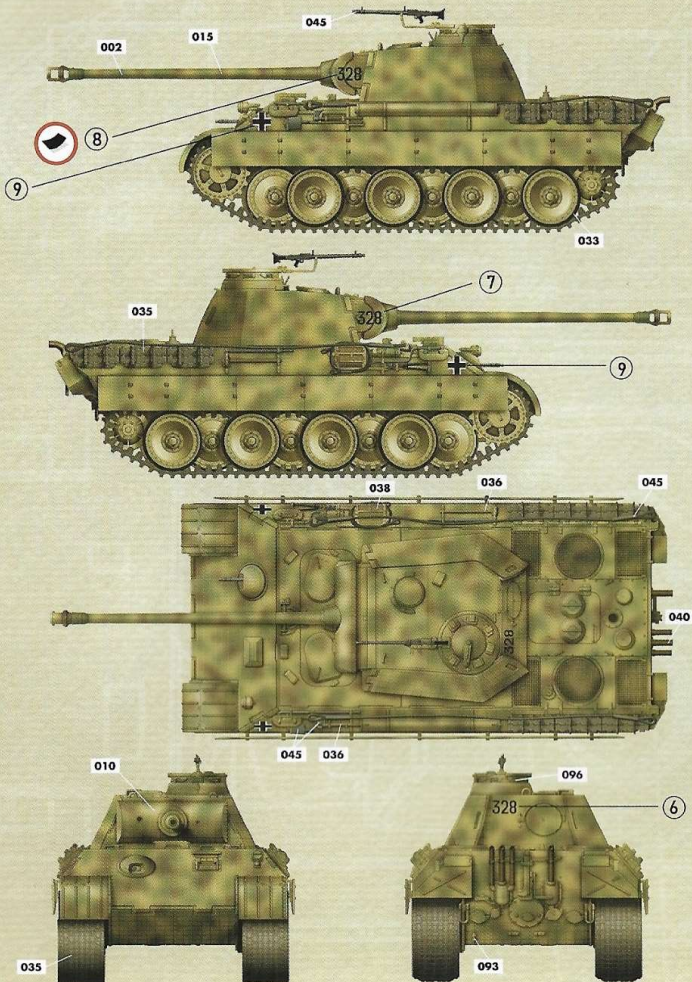

3 Kompanie, Pz. Reg. Grossdeutschland,
France June 1944

A.MIG 033	Rubber & Tires	A.MIG 035	Dark Tracks	A.MIG 036	Old Wood	A.MIG 038	Old Wood
A.MIG 040	Medium Rust	A.MIG 045	Gun Metal	A.MIG 093	Crystal Red	A.MIG 096	Crystal Periscope Green
A.MIG 002	Olivgrün Opt.2	A.MIG 010	Dunkelgelb Mid war	A.MIG 015	Schokobraun		

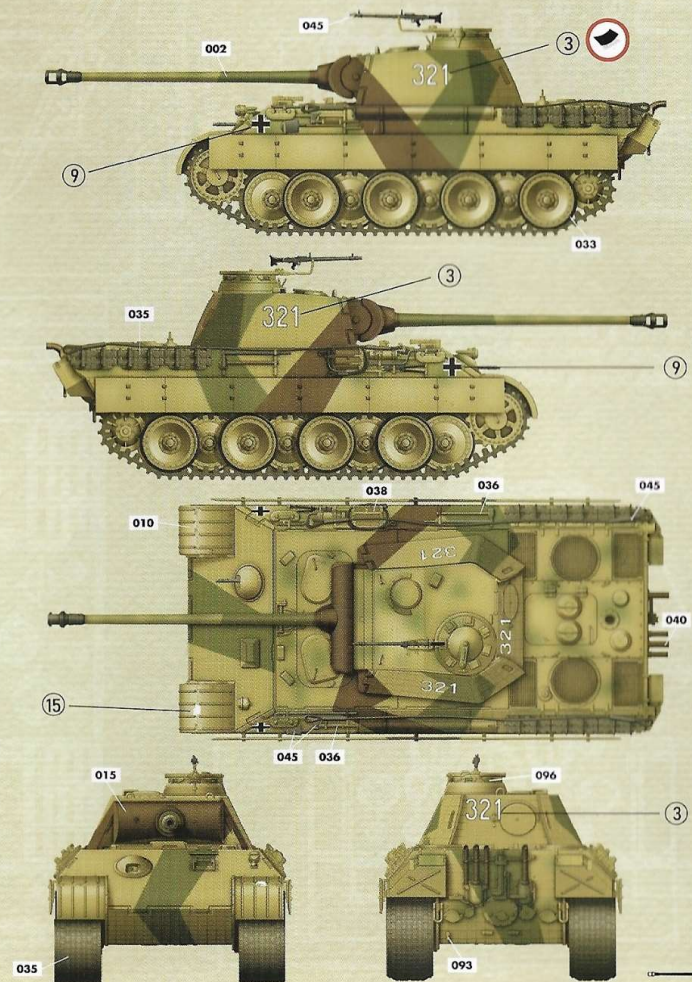

SUYATA

Panther A, Stab I Abteilung SS Pz Reg 2,
France 1944

www.migjimez.com



A.MIG 033	Rubber & Tires	A.MIG 035	Dark Tracks	A.MIG 036	Old Wood	A.MIG 038	Old Wood
A.MIG 040	Medium Rust	A.MIG 045	Gun Metal	A.MIG 093	Crystal Red	A.MIG 096	Crystal Periscope Green
A.MIG 002	Olivgrün Opt.2	A.MIG 010	Dunkelgelb Mid war	A.MIG 015	Schokobraun		

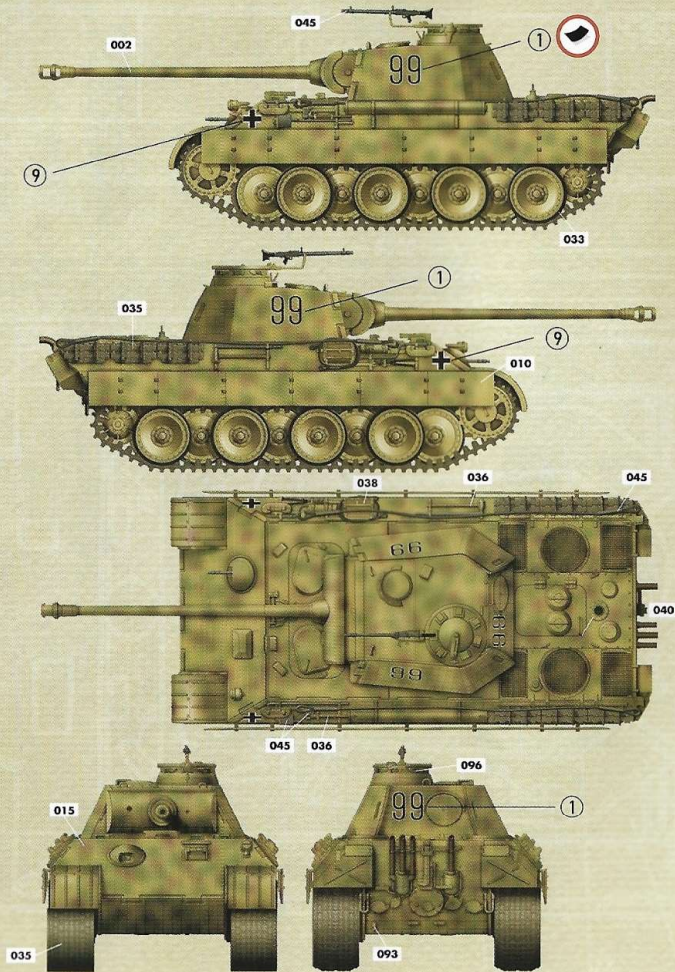

Panther A, 4 kompanie SS Pz Reg 2,
Mont Ormel, Italy 1944

A.MIG 033	Rubber & Tires	A.MIG 035	Dark Tracks	A.MIG 036	Old Wood	A.MIG 038	Old Wood
A.MIG 040	Medium Rust	A.MIG 045	Gun Metal	A.MIG 093	Crystal Red	A.MIG 096	Crystal Periscope Green
A.MIG 002	Olivgrün Opt.2	A.MIG 010	Dunkelgelb Mid war	A.MIG 015	Schokobraun		

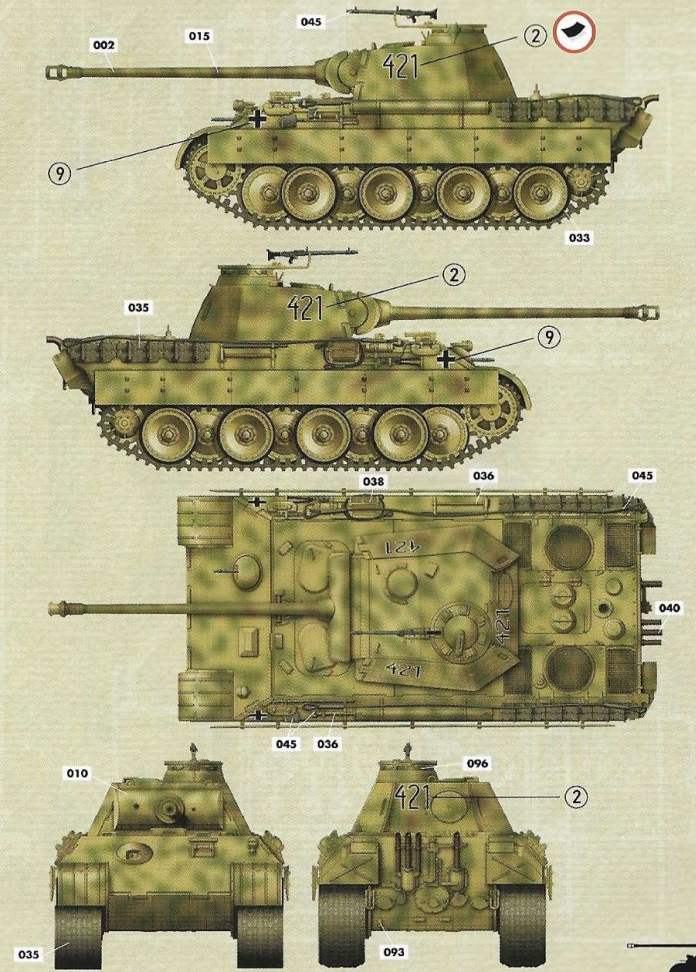

SUYATA

2nd Kompanie, Panzer Regiment 'Großdeutschland',
Karachev, September 1943.

www.migimenez.com



- A.MIG 033** Rubber & Tires
- A.MIG 050** Matt White
- A.MIG 192** Polished Metal
- A.MIG 195** Silver
- A.MIG 002** Olivgrün Opt.2
- A.MIG 011** Dunkelgelb
ALS 44 DG 1

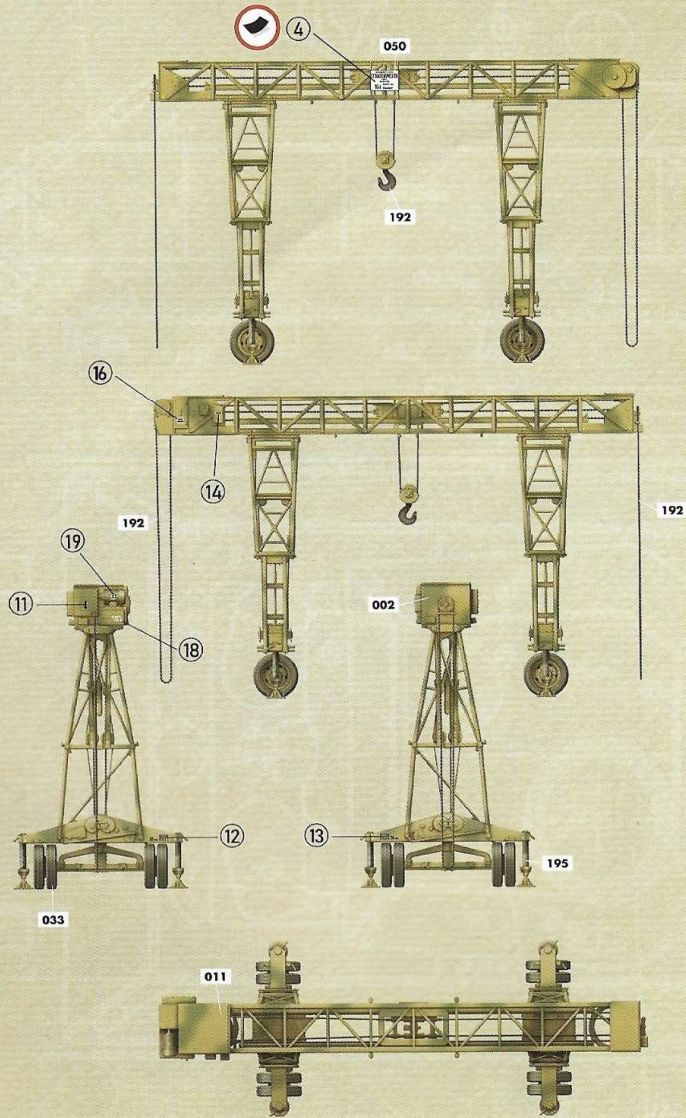

1/48 'Fries Kran' 16T Strabokran 1943/44
production, due Late-September.

- A.MIG 033** Rubber & Tires
- A.MIG 050** Matt White
- A.MIG 192** Polished Metal
- A.MIG 195** Silver
- A.MIG 001** Olivgrün Opt.1
- A.MIG 010** Dunkelgelb
Mid war
- A.MIG 015** Schokobraun

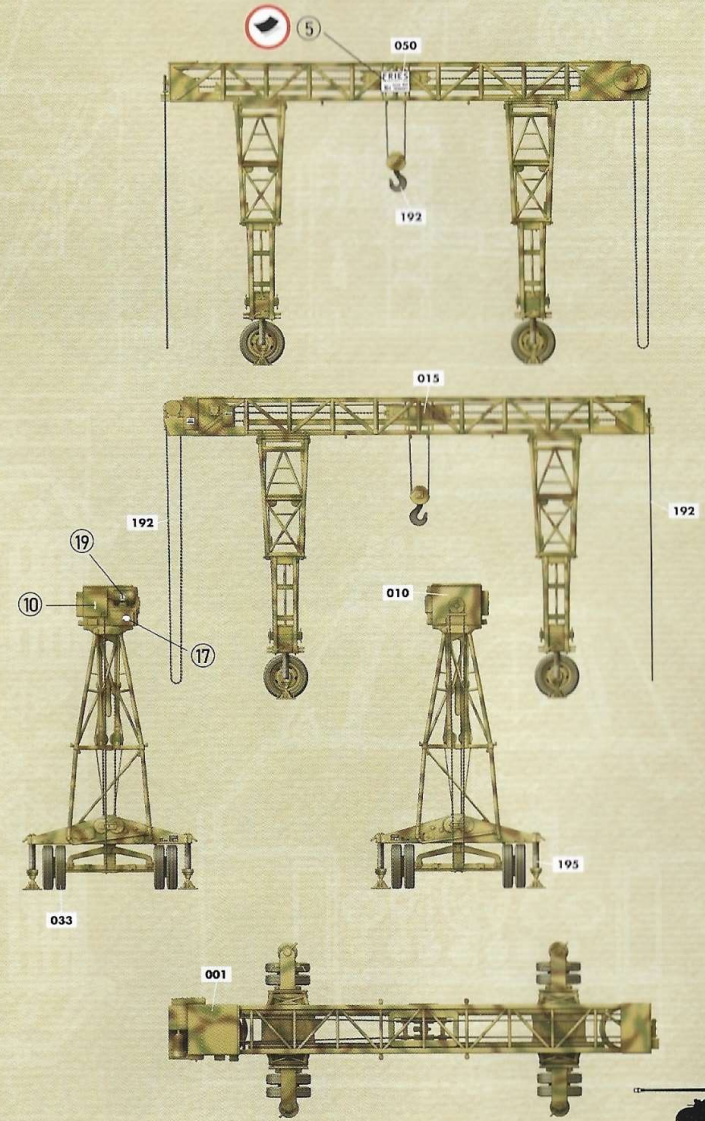

SUYATA

SUYATA®



Facebook



WeChat



Weibo