

**PAINTING GUIDE FOR COCKPIT SIDEWALLS**

**NOTE**  
 FOR EASE OF PAINTING WE PROVIDED THE RIGHT SIDEWALL AS A SEPARATE PIECE. GLUE IN PLACE AFTER PAINTING THE COCKPIT TUB.

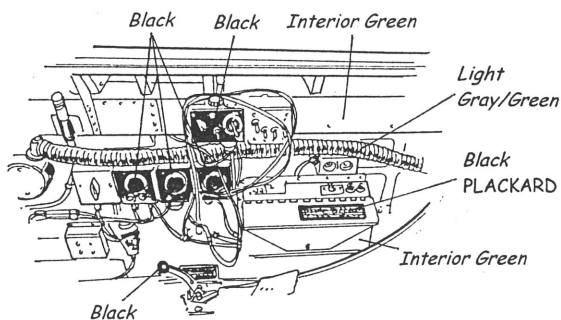
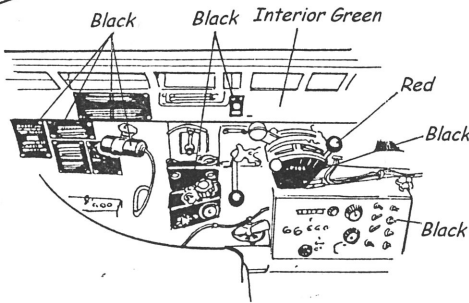

**RECOMMENDED MARKINGS**  
 Check AEROMASTER's catalog for colorful "RAZORBACK" markings.

REMOVE SHADED AREAS

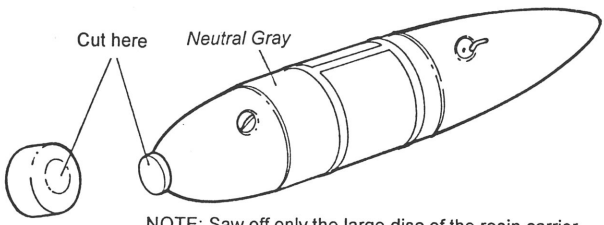
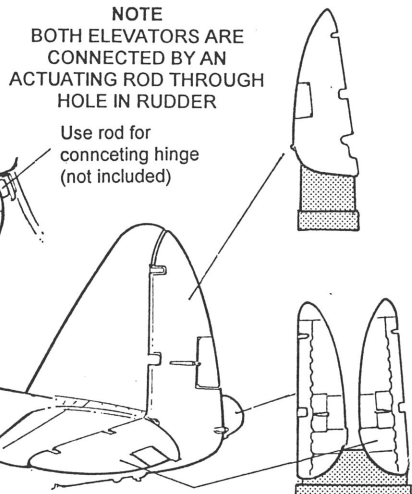
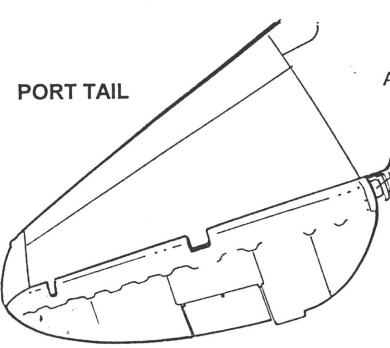

**NOTE:** Saw off only the large disc of the resin carrier. Shave remaining material to shape. Sand smooth

**COLORS**  
 Metal Tanks, when Natural Metal, often used straps of the previous underside color (usually Neutral Gray)

**COLORS**  
 Paper Tanks were painted very bright or dull Aluminum or the aircraft underside color. Straps were often a contrasting color and Red is identified in several color photos.

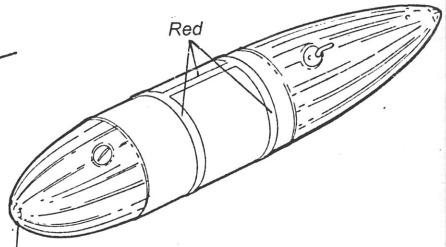
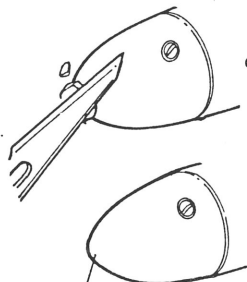

**STBD WING SHOWN**

