

ITEM NO.:05739

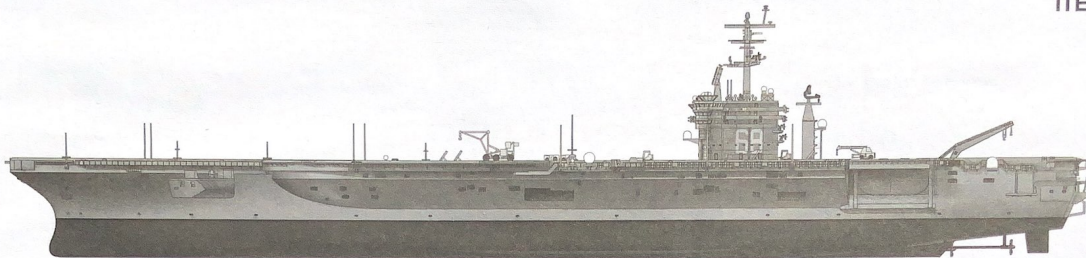

USS NIMITZ CVN-68 2005

1:700 SCALE

美国海军尼米兹号航空母舰 CVN-68 2005 年

READ BEFORE ASSEMBLY:

- This kit is not recommended for inexperienced modelers or for children under 14 years of age
- Study and understand these instructions thoroughly before beginning assembly
- When needed, remove photo-etch parts carefully using a modeling knife or photo etch sprue cutter, being careful not to damage or lose small parts.
- Take extra care in handling photo etch parts in order to avoid injury
- Apply instant cement sparingly to photo etch parts where instructed

- Tools recommended(not included in kit):Plastic and instant cements,sprue cutters,long nose pliers,modeling knife, small files, tweezers, pin vise & scissors. Soft cloth and sandpaper will also assist in construction
- Glue and paint are not included in the kit. Use plastic cement and hobby paints only. Color guide for purchasing paint is included in the kit.
- Keep out of reach of children. They must not be allowed to ingest small parts or handle plastic bags in any way.

装配之前仔细阅读

- 小心用模型锉刀锉平所有零件表面的注射浇口。
- 小心用刀片切下蚀刻片零件，不要遗失小零件。
- 用强力快干胶水粘合蚀刻片零件和金属轴。过量的快干胶水使用可能导致可动零件会粘住，小心涂胶。
- 取蚀刻片时应特别注意安全，防止利边划伤手指。
- 某些零件表面需贴水上贴纸，请选择在装配的同时进行。
- 推荐模型工具(自备)：胶水，水口剪刀，长咀钳，刀片，锉刀，镊子钳，钻，剪刀，瞬间快干胶。
- 软布同砂纸同时也应该是必备工具。
- 请使用塑料胶水和油漆，模型内不含。
- 谨防小孩吸吮塑料零件，或者将塑料袋套在头上，制作时应将套材远离小孩接触。
- 本产品不适合14岁以下没有经验的模型爱好者。

水贴纸的使用:

1. 从水贴纸上剪下印花;
2. 将印花放入温水中浸10秒，然后放在干净布上。
3. 拿着印花纸将印花移到模型上;
4. 手指蘸水将印花移到适当的位置;
5. 用软布轻压印花直至水干，汽泡消失。

DECAL APPLICATION:

1. Cut decals from sheet as needed
2. Dip the decal in warm water for about 10 seconds and then place on soft clean cloth.
3. Hold the decal backing sheet edge and gently slide the decal onto the model in its proper position.

4. While still wet, decal can be adjusted for better fit on model by dampening it gently with your finger.
5. When placed in the proper position, gently press decal down with a soft cloth until excess water and air bubbles are gone.
6. Allow decal to dry completely before handling model



cyanoacrylate glue
使用强力胶



weight
配重



make hole
钻孔



cut / remove
切除



option
选择



no cement
不涂胶水



decal
贴纸



bend
弯曲



file / sand
锉平

05739

1

部品图

Parts

<<上船体>>
UP HULL

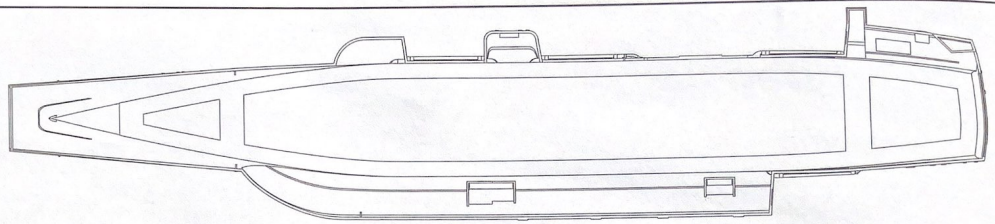

<<下船体>>
LOWER HULL

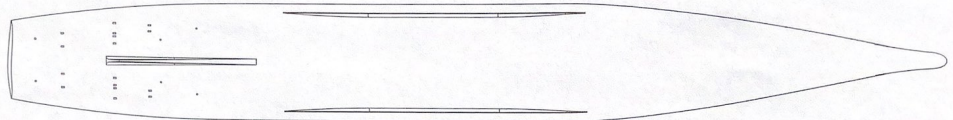

<<飞行甲板(透明件)>>
FLIGHT DECK (GREY PART & CLEAR PART)

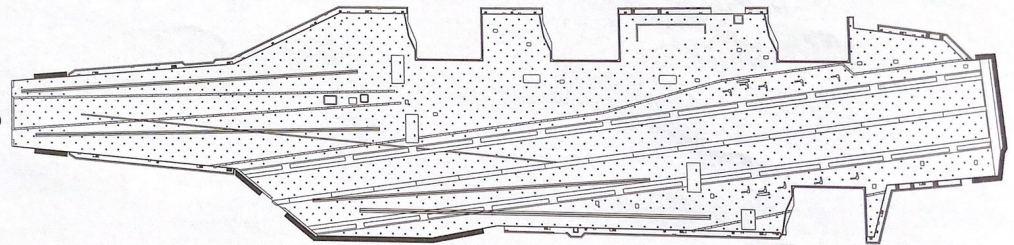

<<机库甲板(透明件)>>
HANGAR DECK (GREY PART & CLEAR PART)

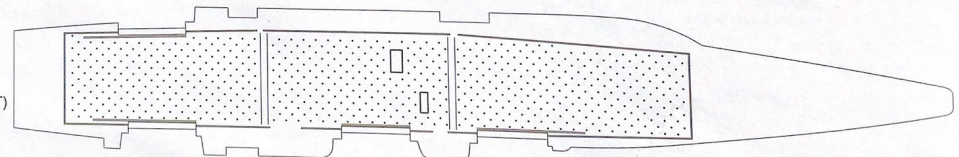

<<水线板>>
WATERLINE PLATE

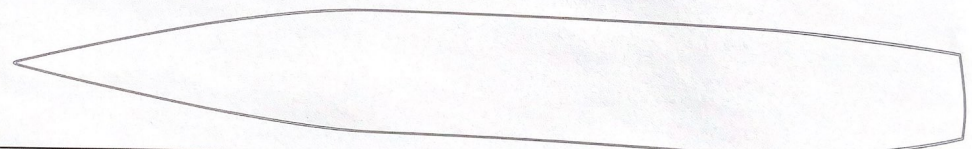

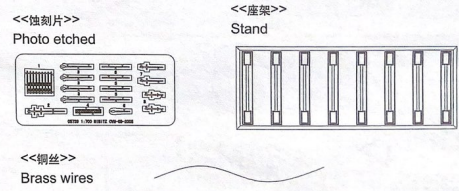
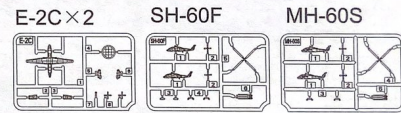
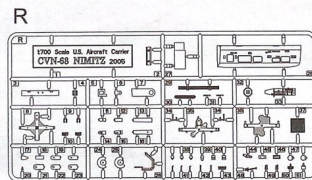
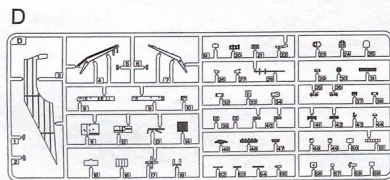
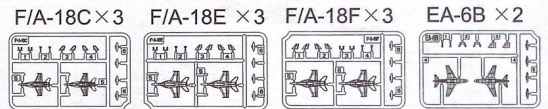
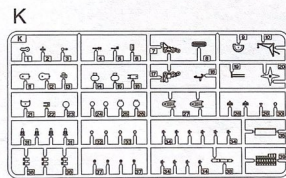
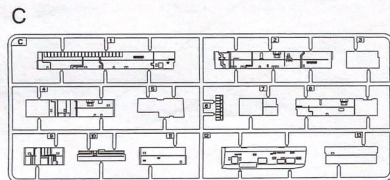
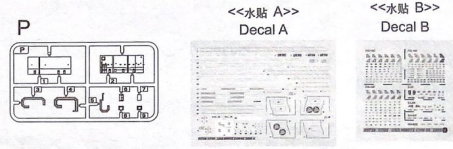
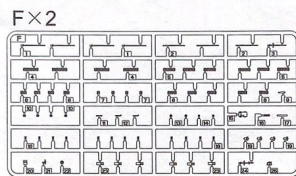
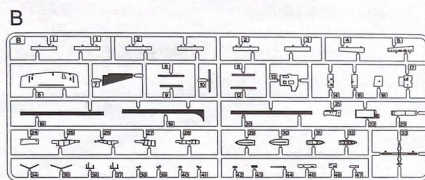
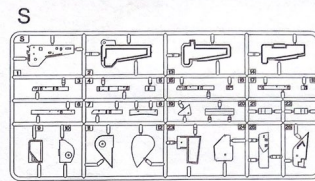
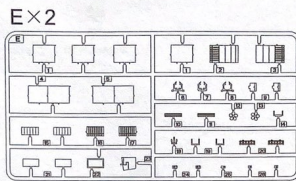
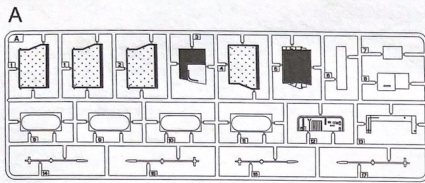

1 舰体部件的组装
 Assembly of hull parts

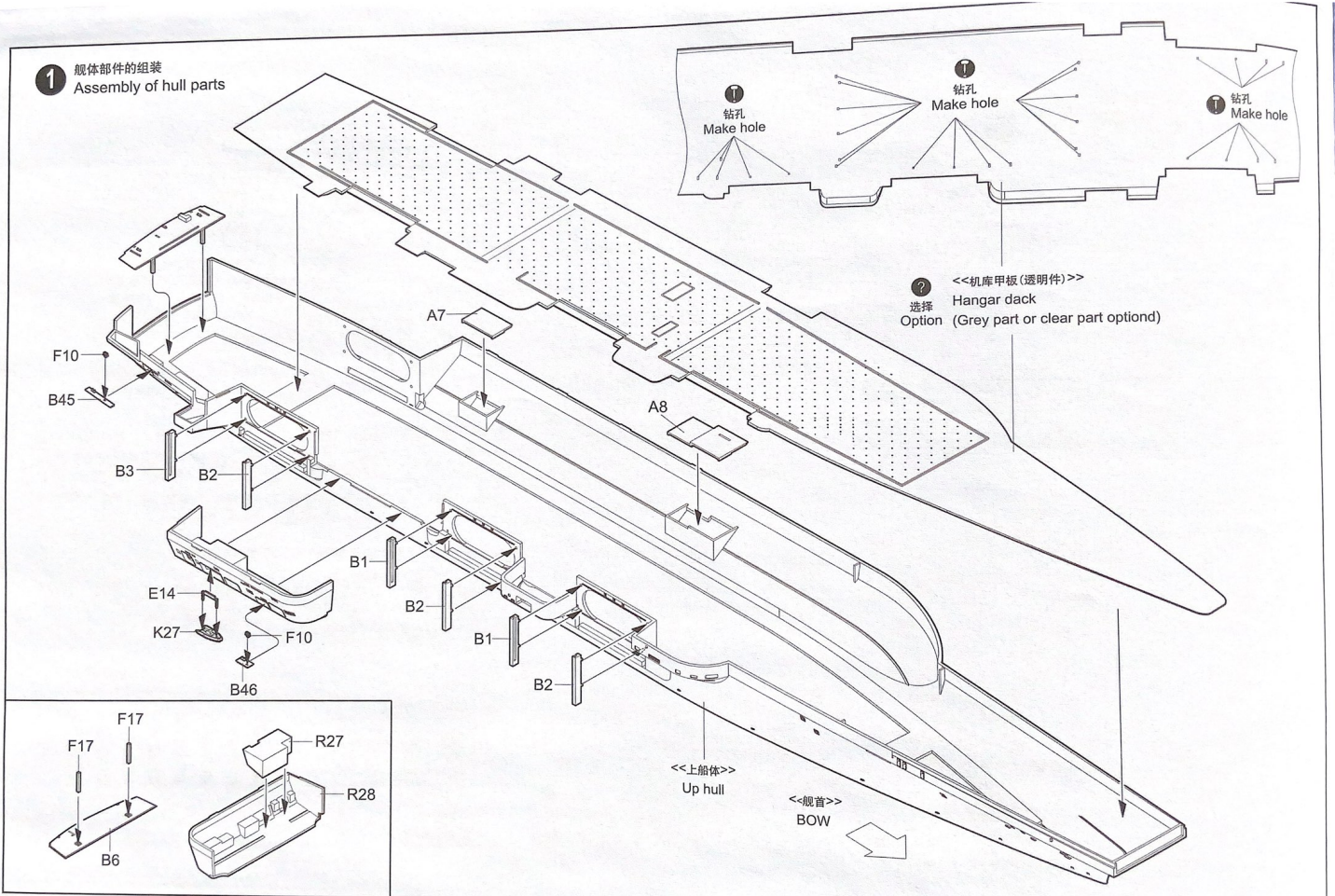

05739

2 舰体部件的组装
Assembly of hull parts

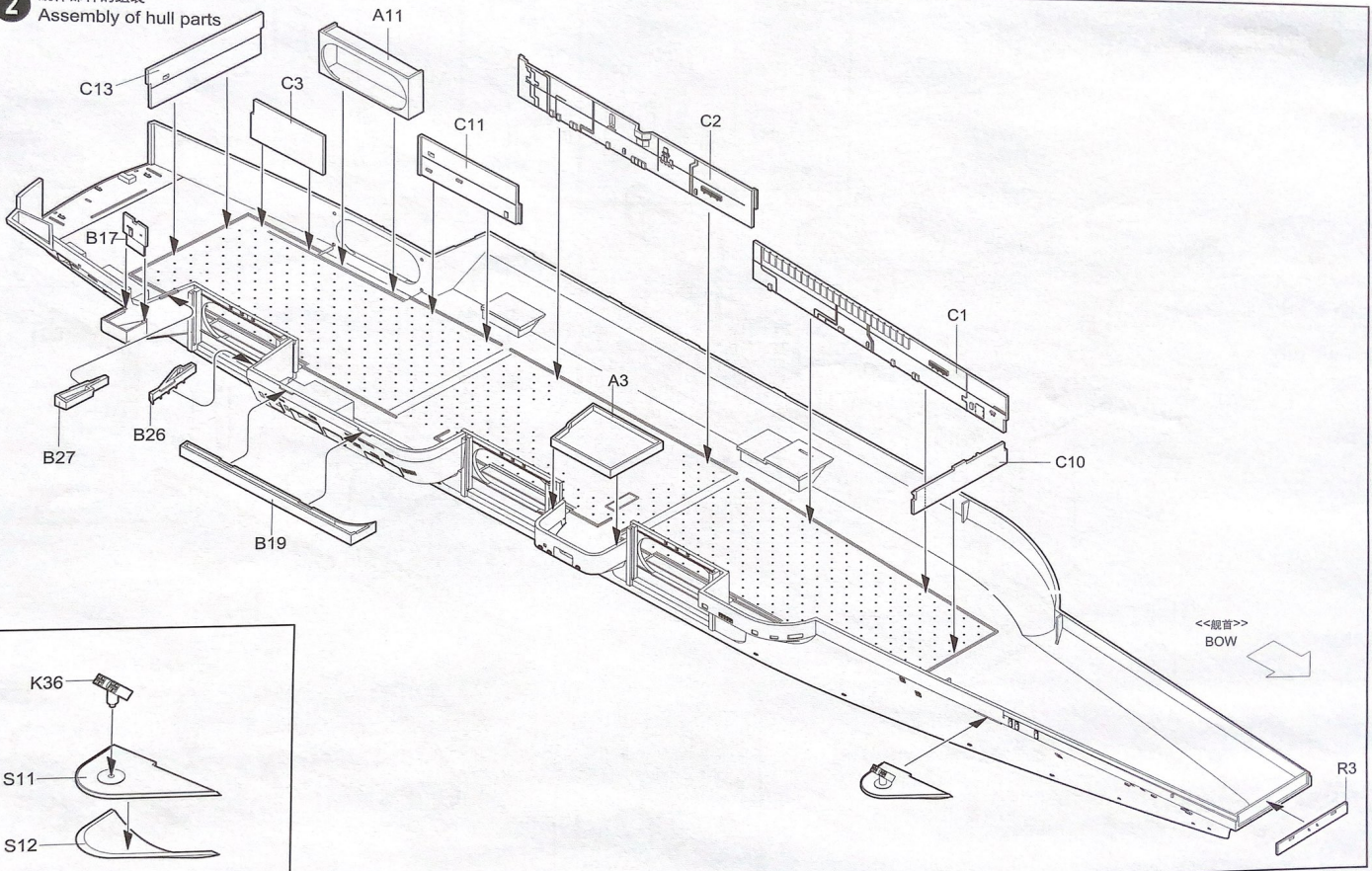

3

舰体部件的组装
Assembly of hull parts

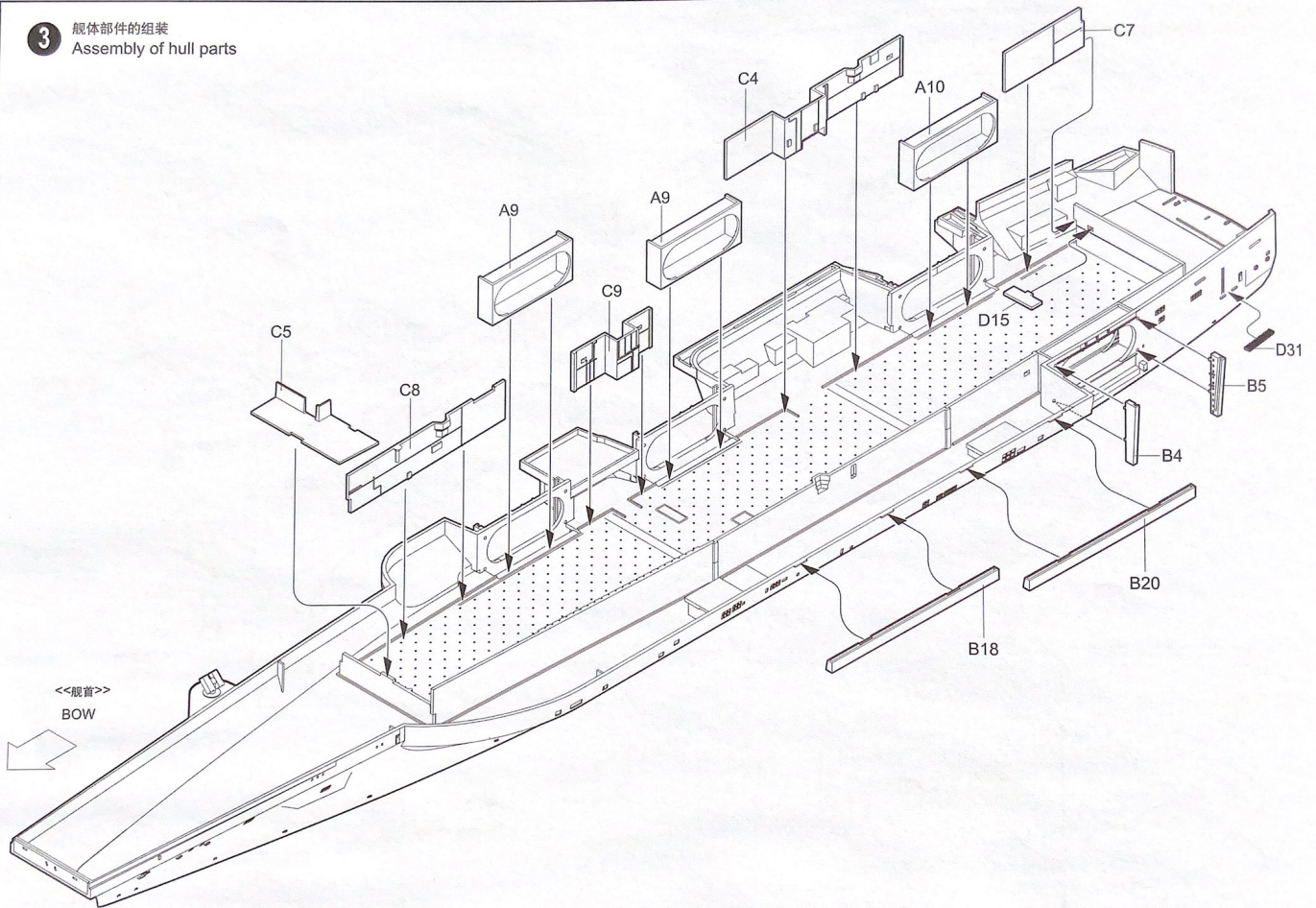

4 舰体部件的组装
Assembly of hull parts

<p><<零件1>> Part 1</p> <p>制作4套 Make four</p>	<p><<零件2>> Part 2</p> <p>制作4套 Make Four</p>	<p><<零件3>> Part 3</p>	<p><<天线1>> Antenna1</p> <p>制作2套 Make two</p>
---	---	---------------------------------------	--

制作2套
Make two

切除
Cut / Remove

PE1

5 舰体部件的组装
Assembly of hull parts

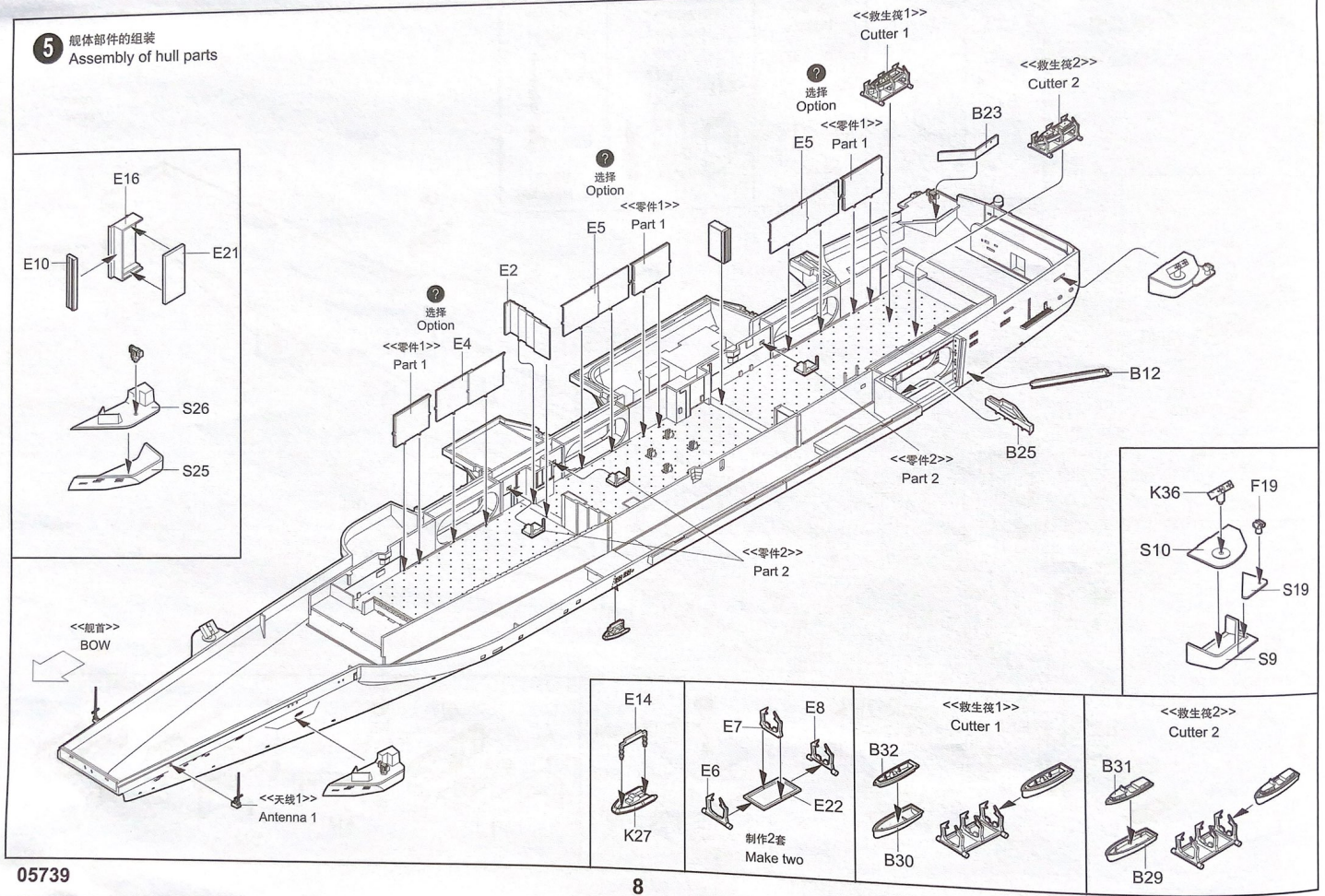

05739

6 舰体部件的组装
Assembly of hull parts

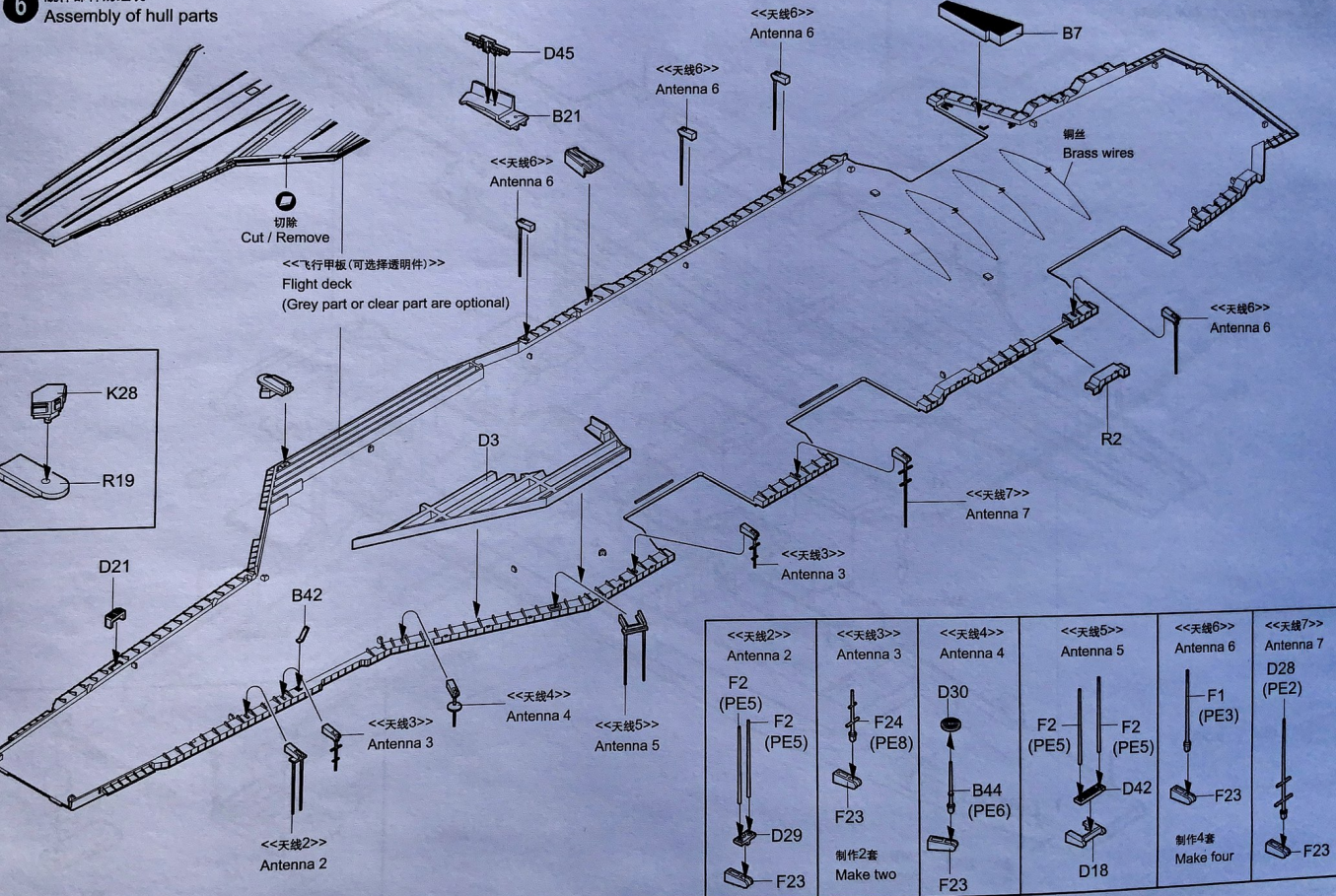

<<天线2>> Antenna 2	<<天线3>> Antenna 3	<<天线4>> Antenna 4	<<天线5>> Antenna 5	<<天线6>> Antenna 6	<<天线7>> Antenna 7
F2 (PE5)	F24 (PE8)	D30	F2 (PE5)	F1 (PE3)	D28 (PE2)
F2 (PE5)	F23	B44 (PE6)	F2 (PE5)	F23	F23
D29	制作2套 Make two	F23	D42	制作4套 Make four	F23
F23			D18		

7 舰体部件的组装
Assembly of hull parts

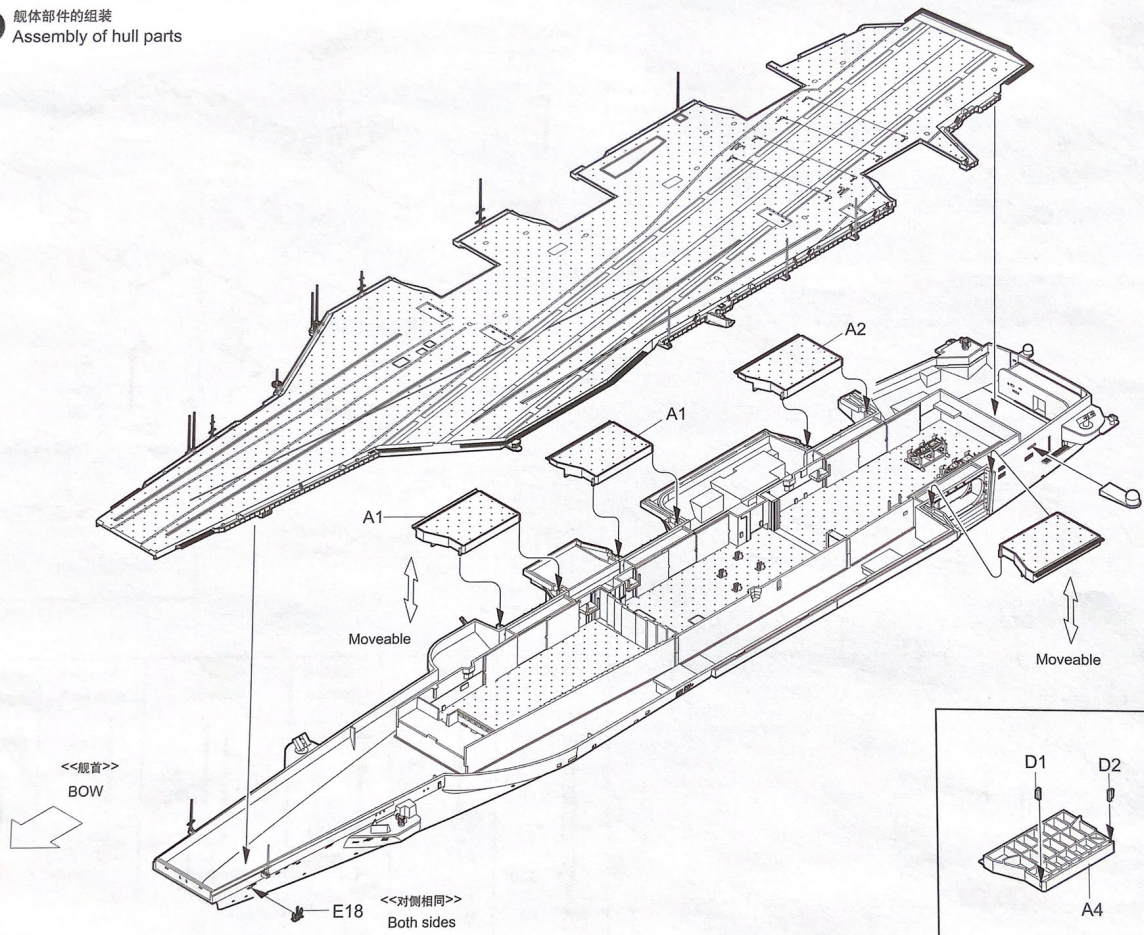

8 舰体部件的组装
Assembly of hull parts

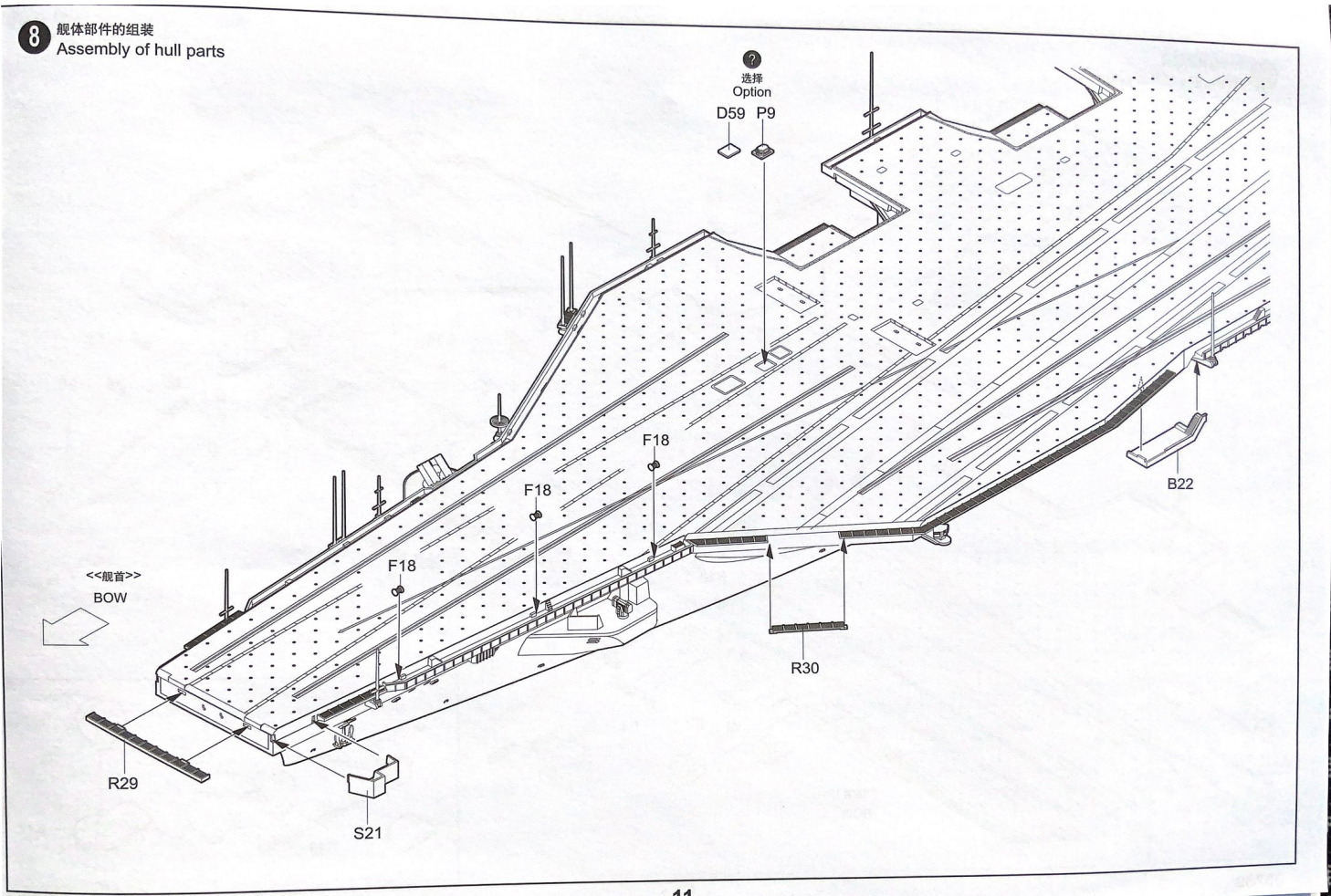

9 舰体部件的组装
Assembly of hull parts

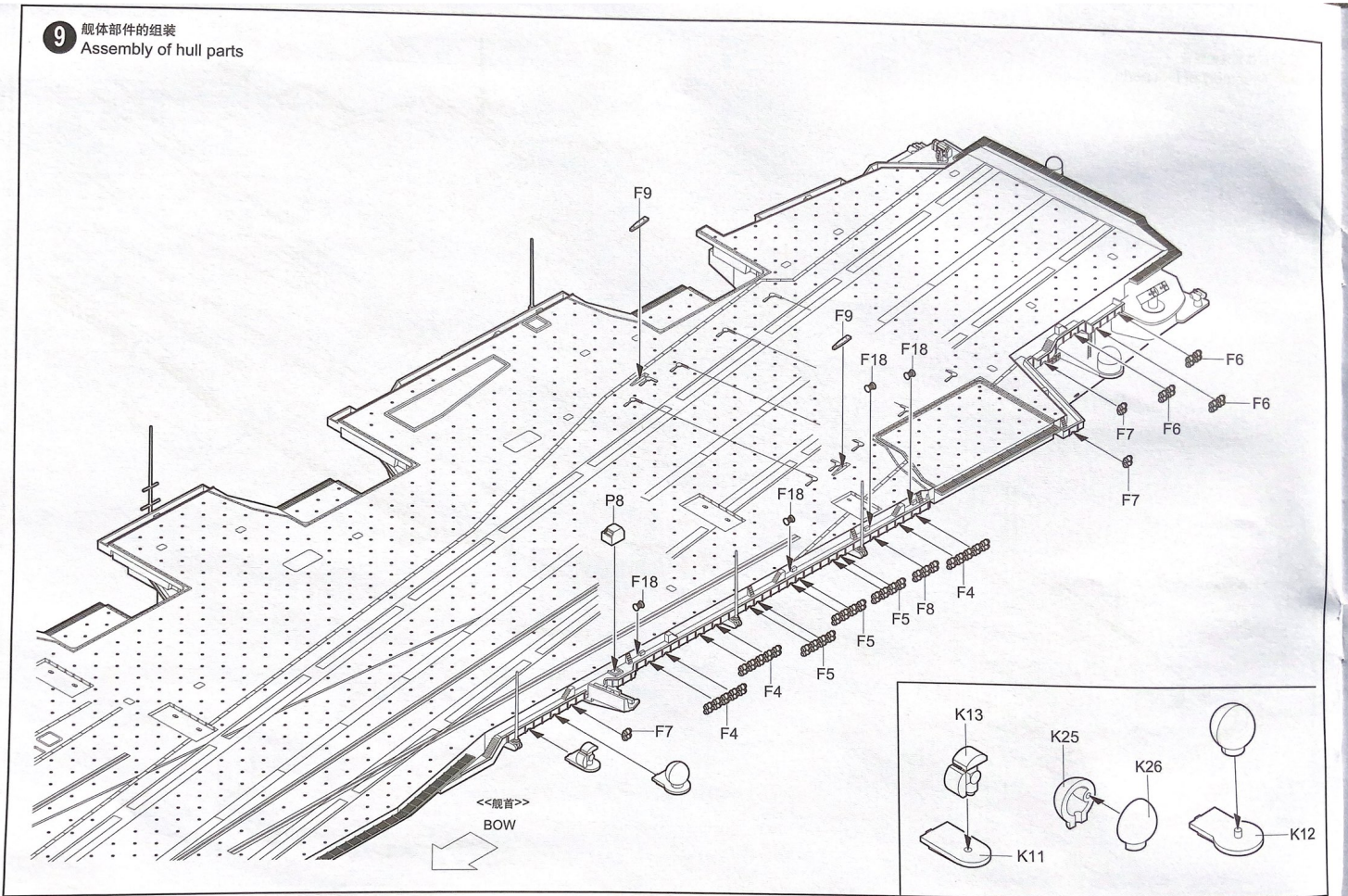

10 舰体部件的组装
Assembly of hull parts

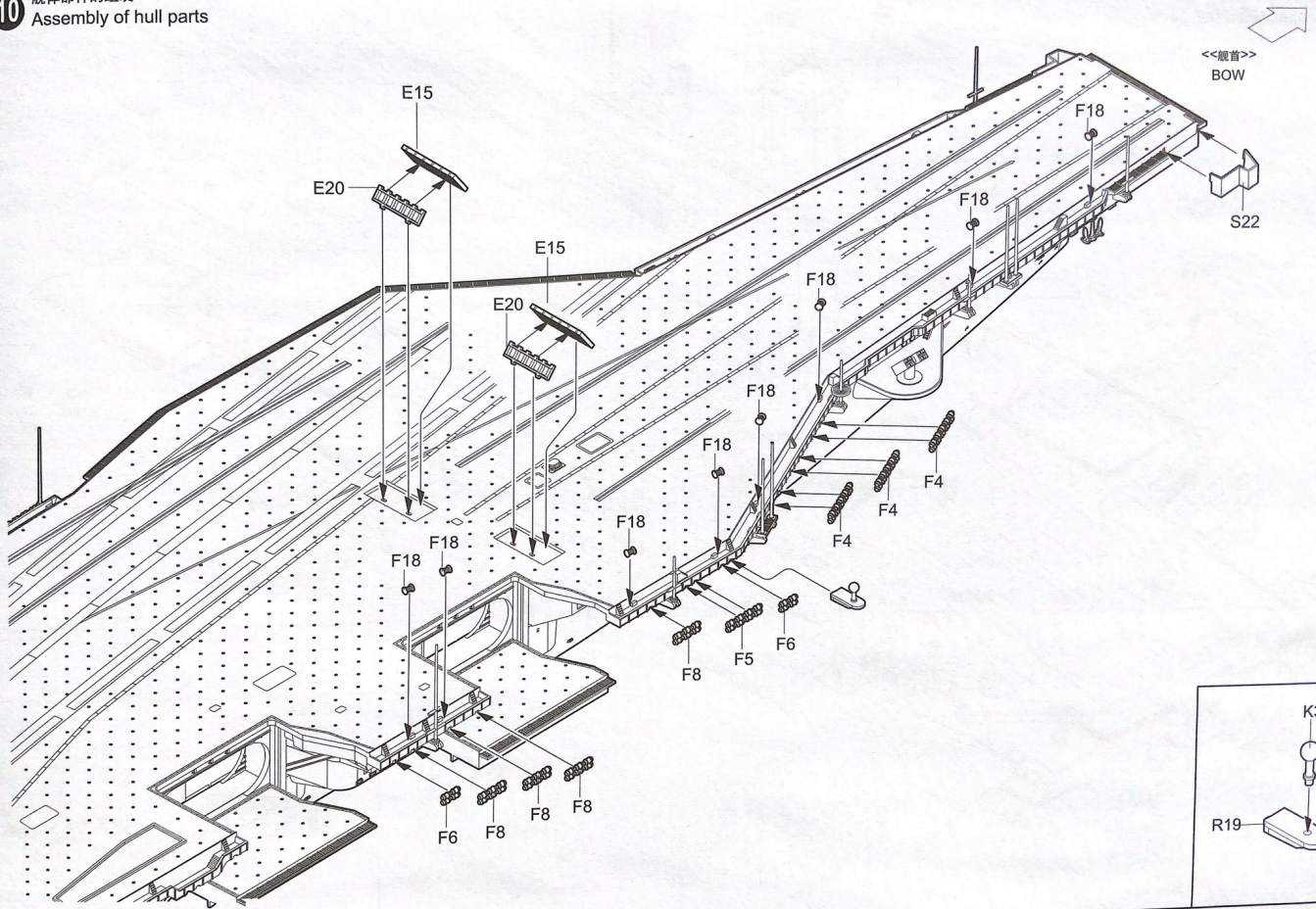

11 舰体部件的组装
 Assembly of hull parts

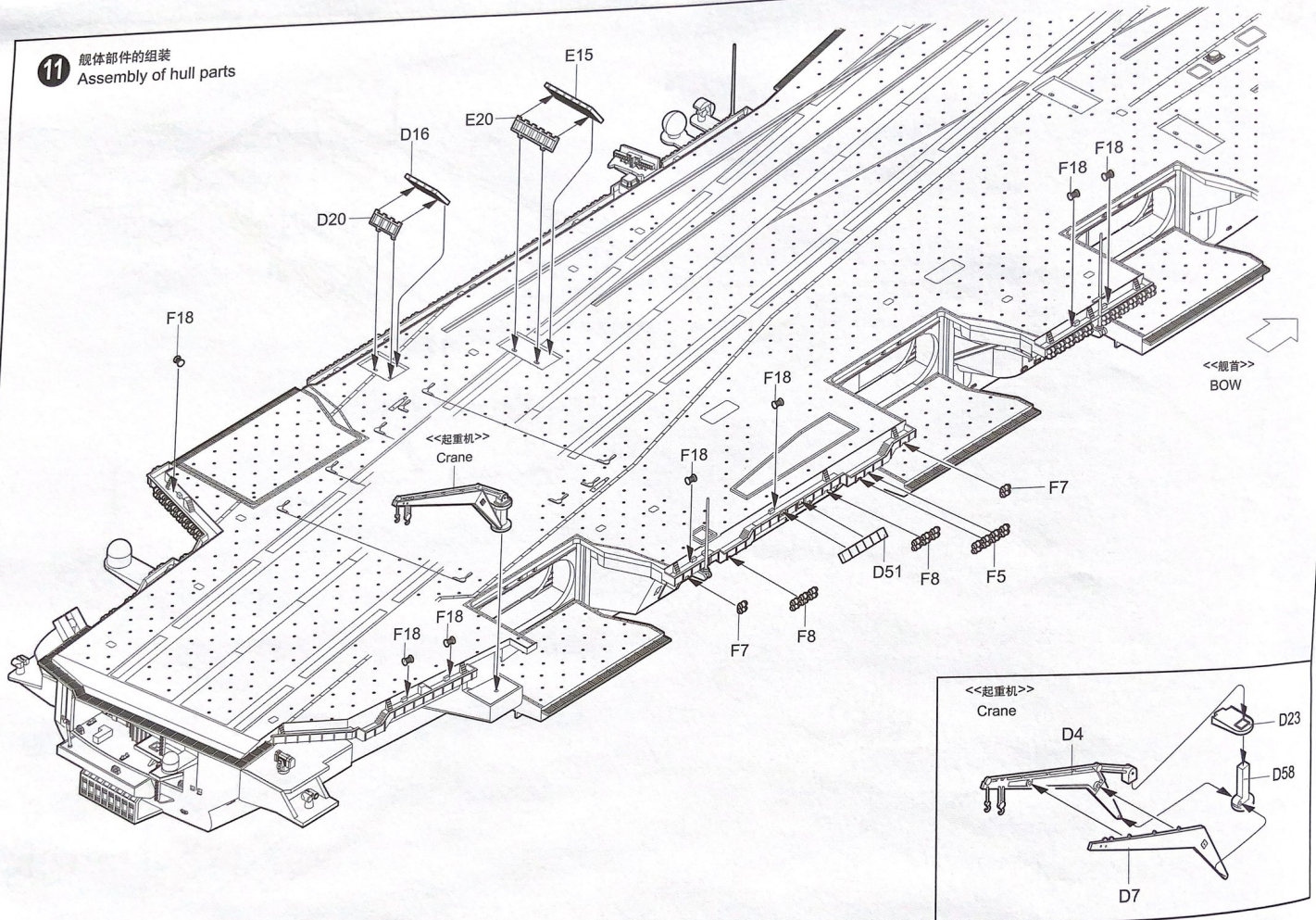

12 舰桥部件的组装
Assembly of Island

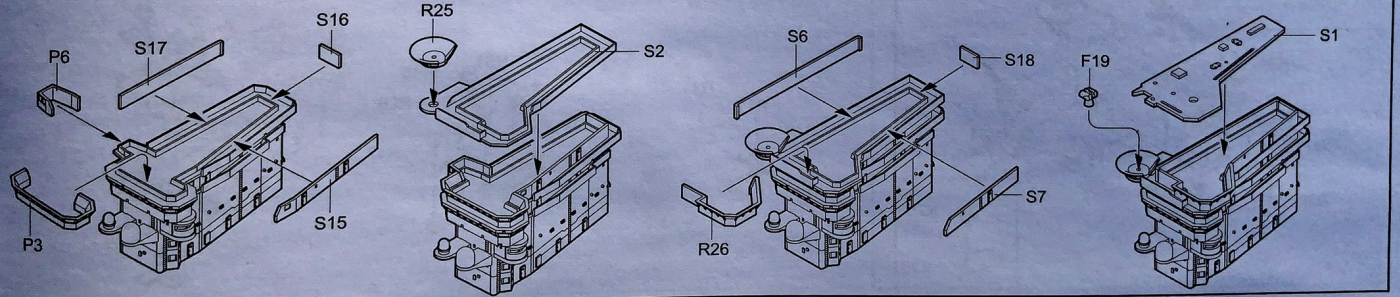
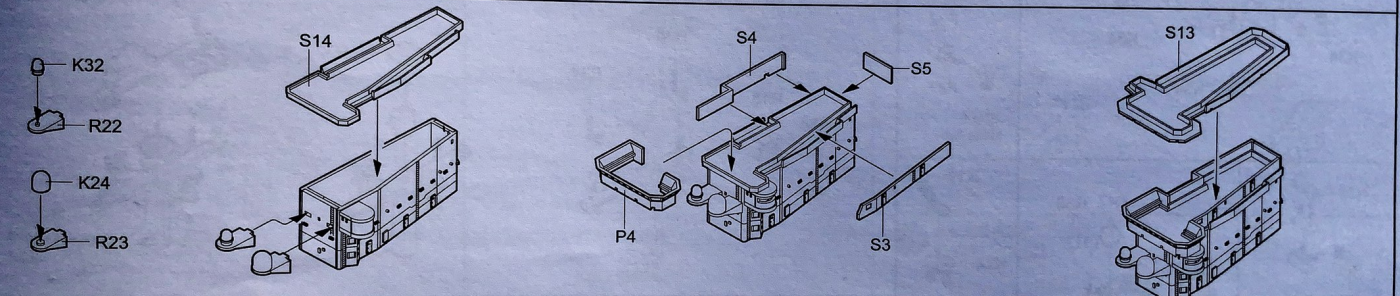
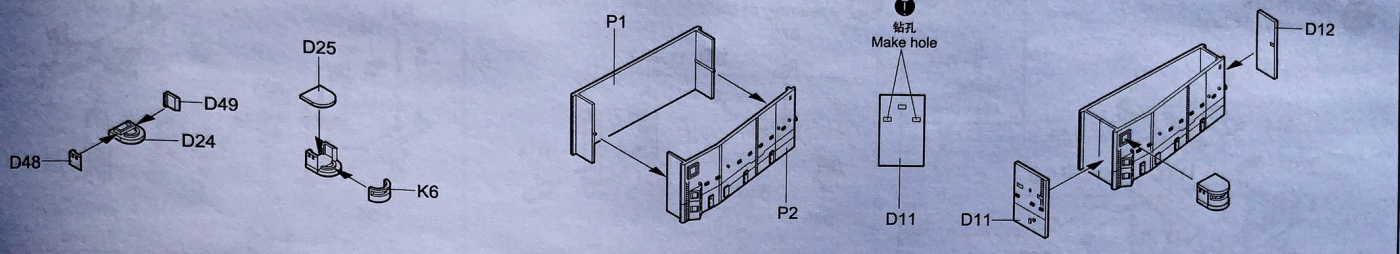

13 舰桥部件的组装
Assembly of Island

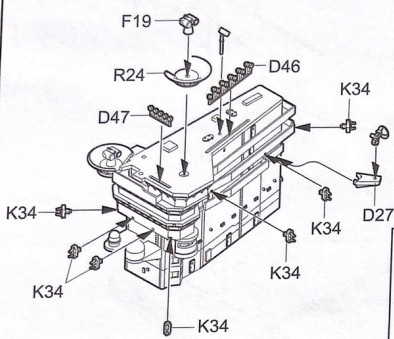

制作3套
Make three

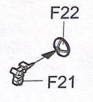

制作2套
Make two

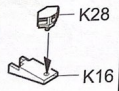
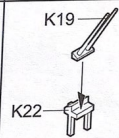
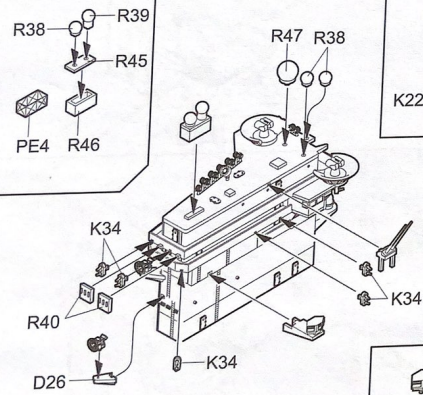

14 桅杆的组装
Assembly of Mast

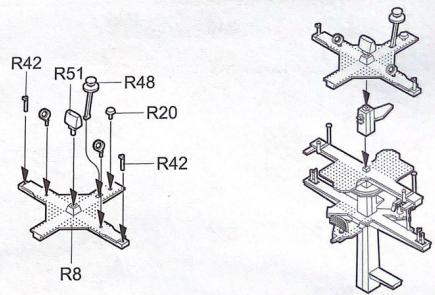
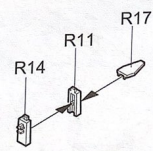
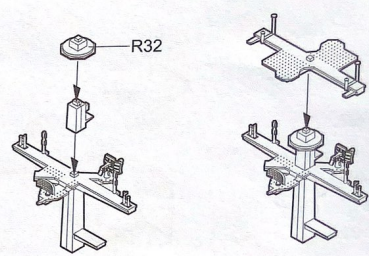
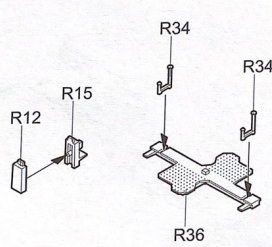
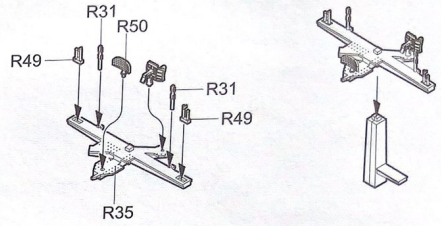
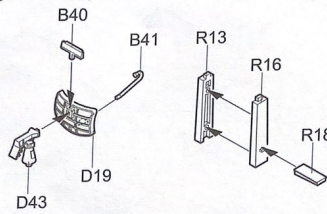

15 三维座标雷达的组装
Assembly of three dimensional Radar

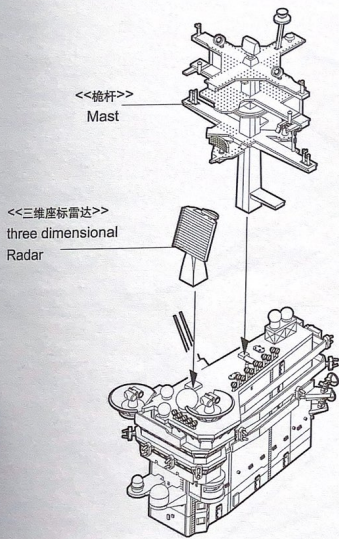
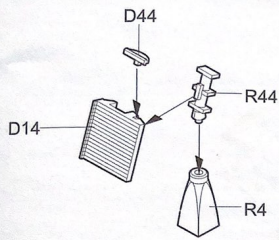

16 主桅杆的组装
Assembly of Main Mast

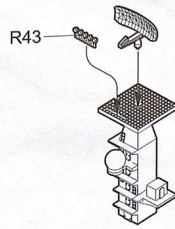
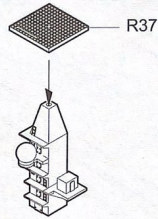
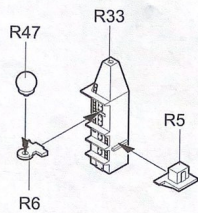

17 失事飞机救援车
Crash truck

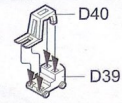

制作2套
Make two

18 车载式起重机1
Mobile Crane1

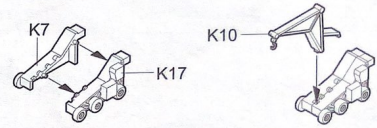

19 车载式起重机2
Mobile Crane2

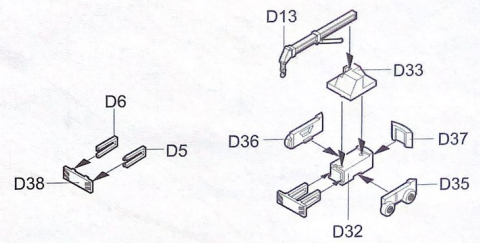

20 完成
Completion

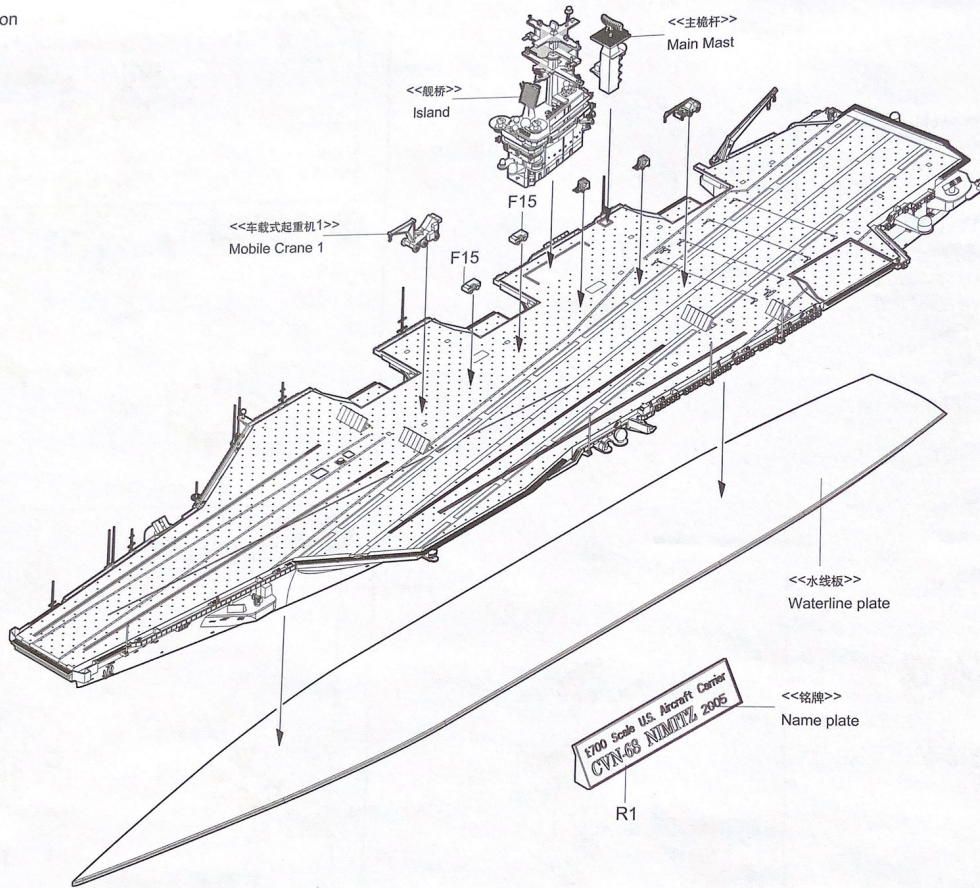

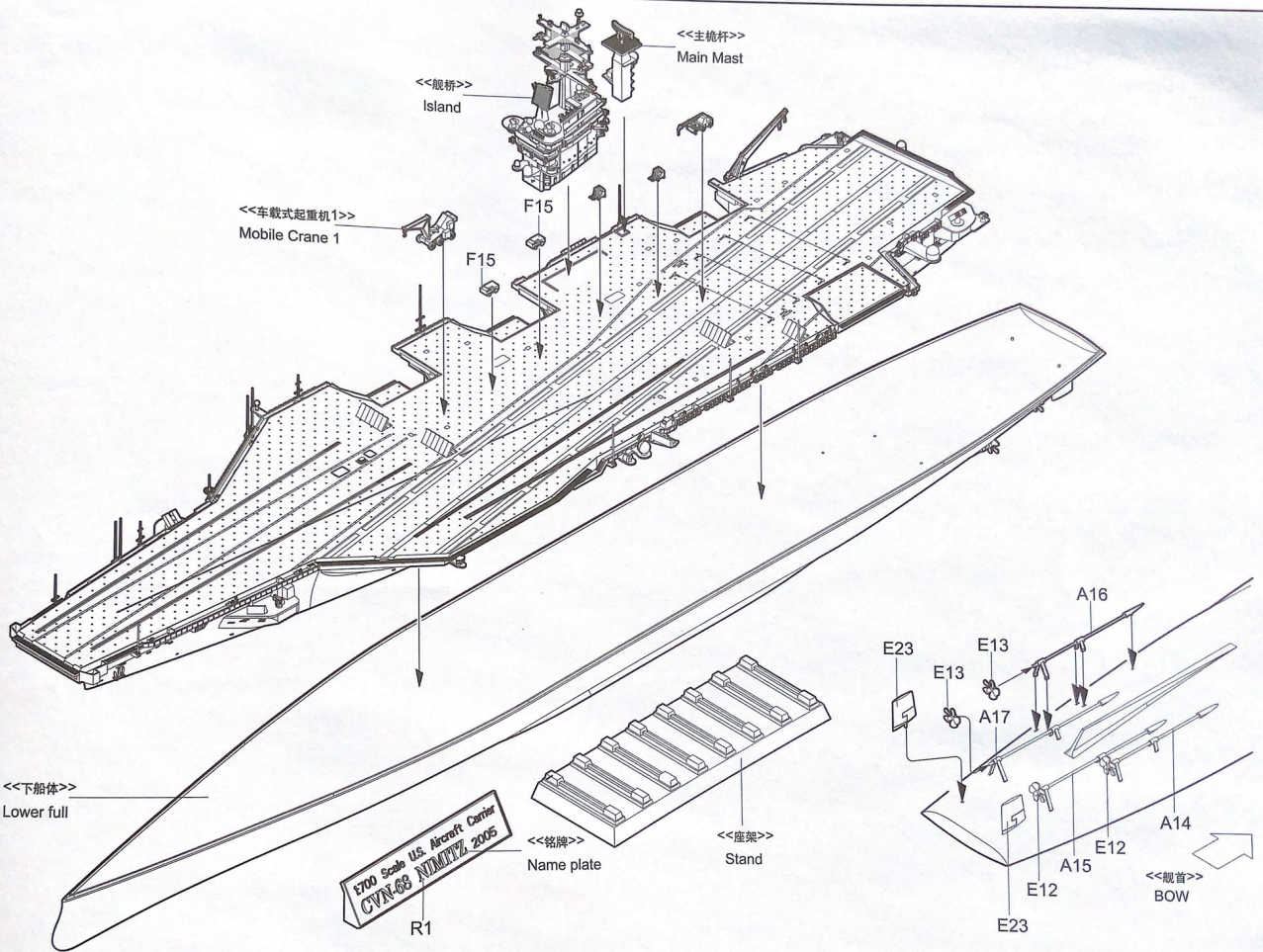

F/A-18C

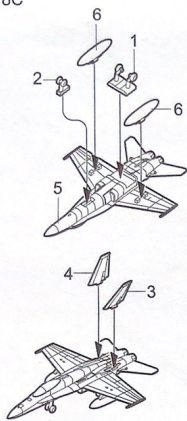

F/A-18E

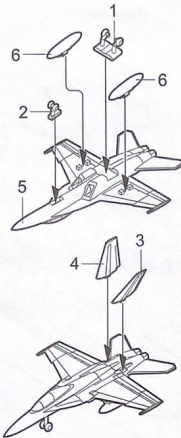

F/A-18F

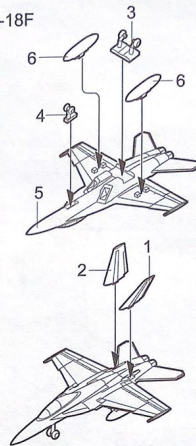

EA-6B

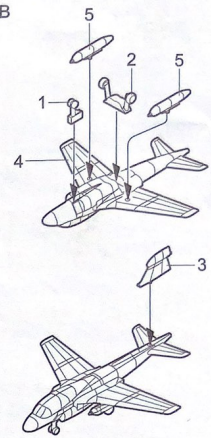

E-2C

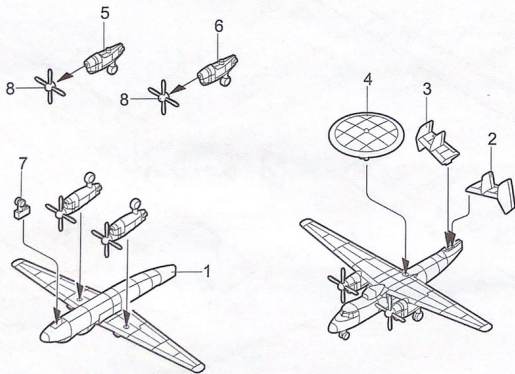

SH-60F

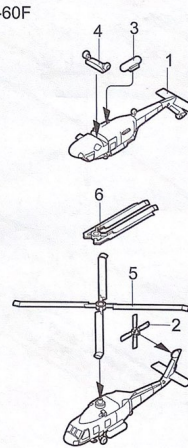

MH-60S

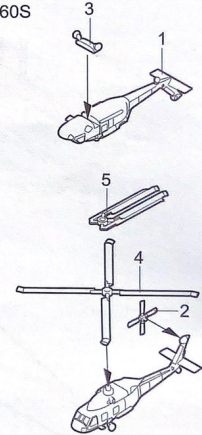

涂装同标贴指示
Painting & Marking guide

使用 MR.HOBBY 涂料 Mr. Color Used

H 61 53	海军灰	Navy gray	H 1 18	消光白	White
H 22 53	灰色	Gray	H 12 53	消光黑	Flat black
H 17 23	船底色	Hull red	H31+32	灰色	Light gull gray
H 9 23	金色	Gold	H31+32	白色	White insignia
H 4 24	黄色	Yellow			

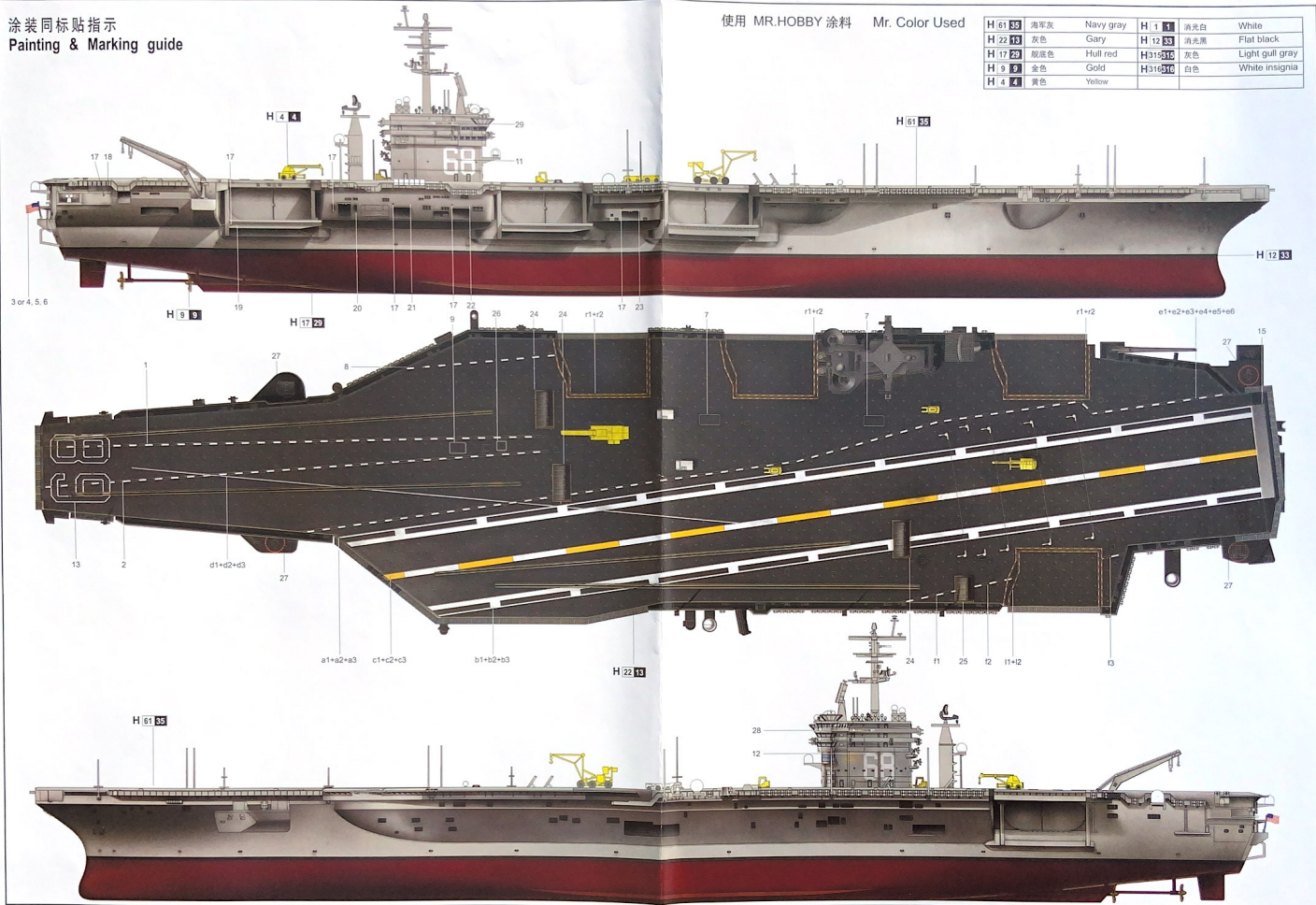

05739 1/700 USS NIMITZ CVN-68 2005

涂装同标贴指示
Painting & Marking guide

F/A18E SUPER HORNET



F/A18C HORNET



SH-60F OCEANHAWK

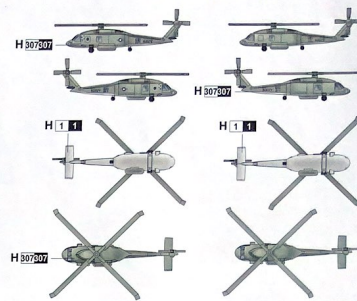

F/A18F SUPER HORNET



EA-6B PROWLER



E-2C HAWKEYE

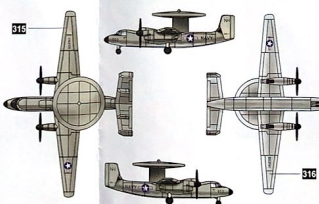

MH-60S PAVEHAWK

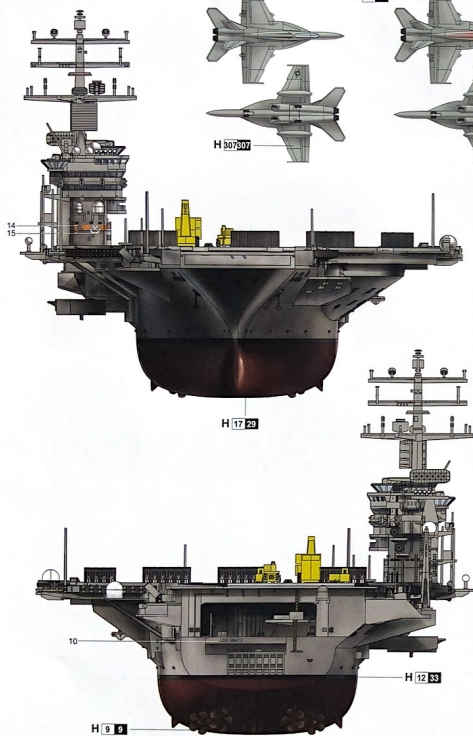
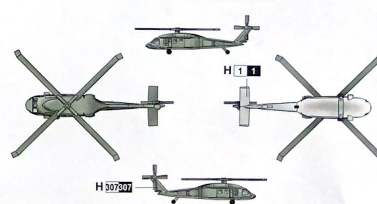

H 1 AQUEOUS HOBBYCOLOR X Mr. COLOR