



AUSTRALIA  
 U.S. ARMY B-24L-1-CO  
 AIR FORCES SERIAL 44-41402  
 SUITABLE FOR AROMATICS  
 SERVICE THIS AIRCRAFT WITH 100  
 OCTANE FUEL IF NOT AVAILABLE  
 T.O.06-5-1 WILL BE CONSULTED  
 FOR EMERGENCY ACTION  
 EXCEPT A.F.C.E

# Royal Australian Air Force

## A72-76 B-24I

### 25 Squadron

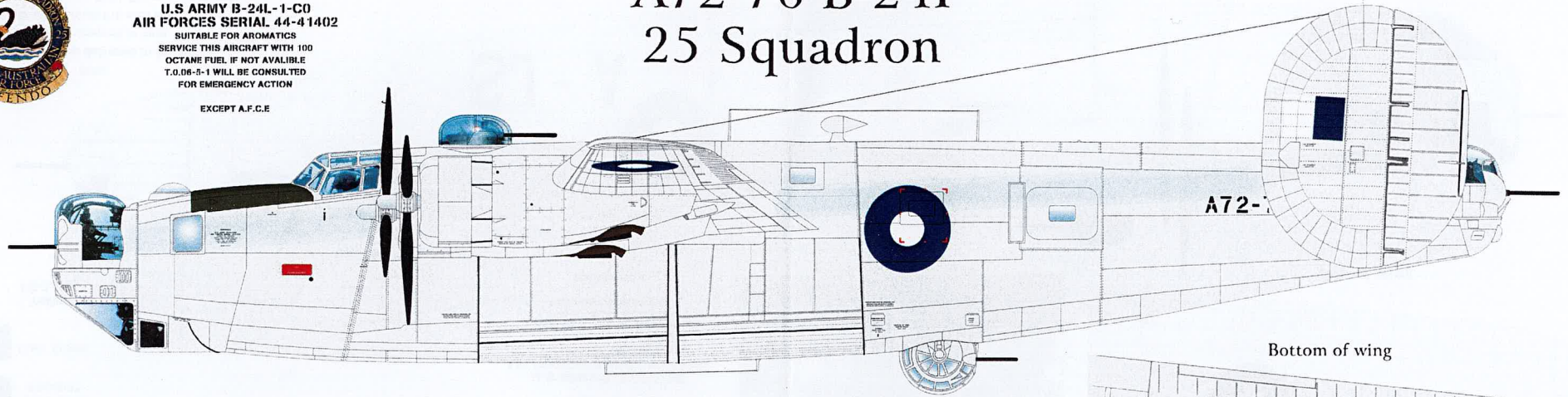

Bottom of wing

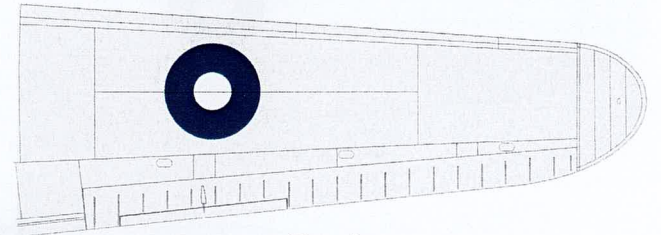
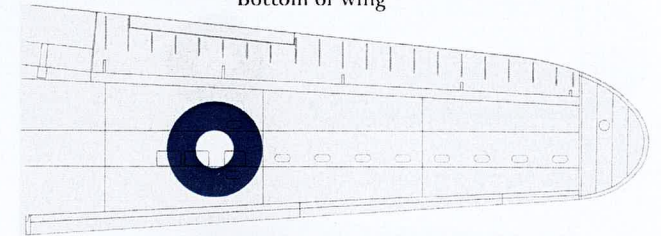

Top of wing

-  Matt Black  
FS27038
-  Overall  
Chrome Silver
-  Olive Drab  
FS34087
-  Dark Brown
-  Yellow  
FS-33538



Propeller

**Note:**

When these were delivered to the RAAF  
 they were covered in data.  
 As time went on, not all the data was applied.  
 For Data Placement see Data Placement sheets.

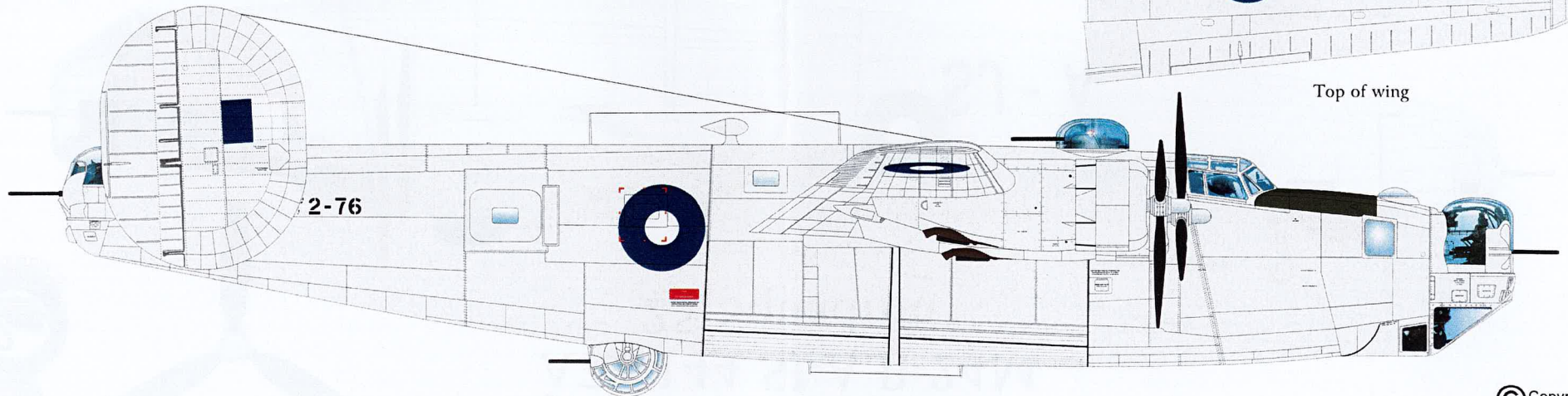



Propeller



# Royal Australian Air Force A72-144 SJ-A B-24M 25 Squadron

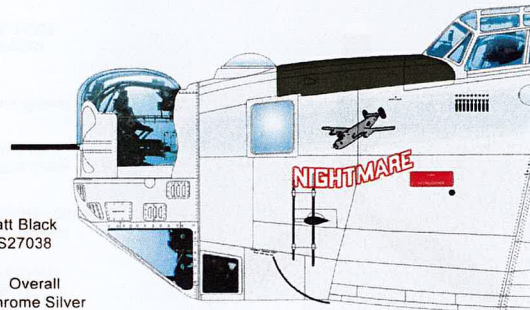

SJ-A A72-144 B-24M-1-CO 44-41831  
Also Carried the Nose art names of  
"ELIZABETH ANN"  
"NIPPONS NIGHMARE"  
"NIGHTMARE"  
AND  
"NELLIES NIGHTMARE"



This data plate was painted over  
by the Nose art.

**AUSTRALIA**

**U.S ARMY B-24M-1-CO  
AIR FORCES SERIAL 44-41831**  
SUITABLE FOR AROMATICS  
SERVICE THIS AIRCRAFT WITH 100  
OCTANE FUEL IF NOT AVAILBLE  
T.O.06-5-1 WILL BE CONSULTED  
FOR EMERGENCY ACTION

EXCEPT A.F.C.F.

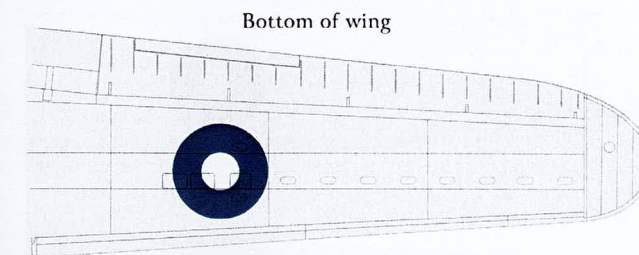

Bottom of wing

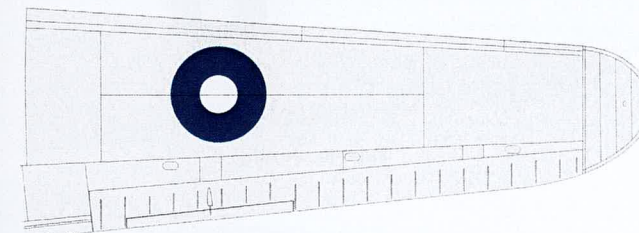

Top of wing

-  Matt Black  
FS27038
-  Overall  
Chrome Silver
-  Olive Drab  
FS34087
-  Dark Brown
-  Yellow  
FS-33538

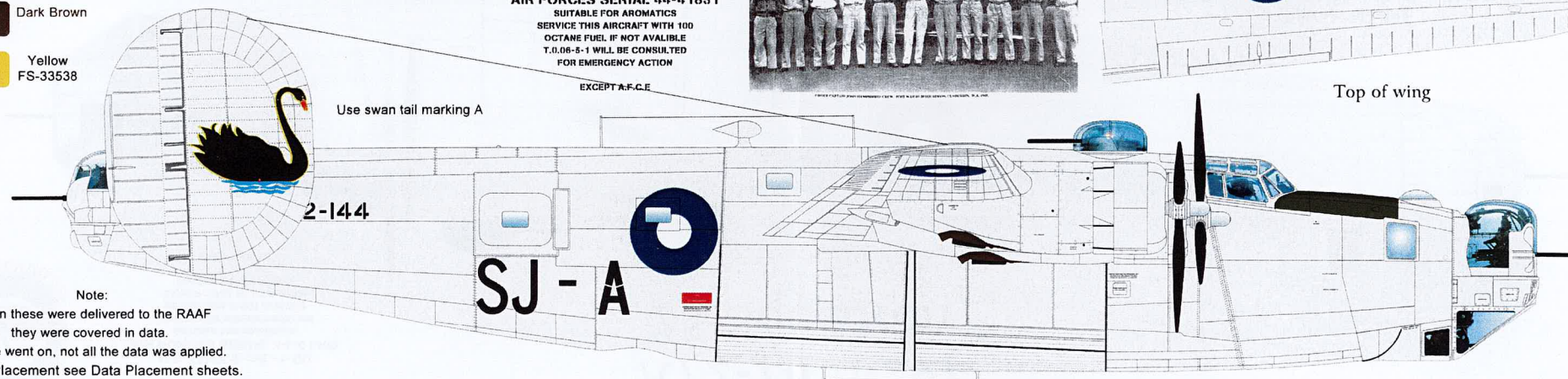

**Note:**

When these were delivered to the RAAF  
they were covered in data.

As time went on, not all the data was applied.  
For Data Placement see Data Placement sheets.



# Royal Australian Air Force A72-152 SJ-F B-24L 25 Squadron

NOTE:  
In the image Below it shows  
That A72-152 had 4 bomb markings painted on her.  
By the end of here time records show that she had  
ended up with 6 bomb markings.

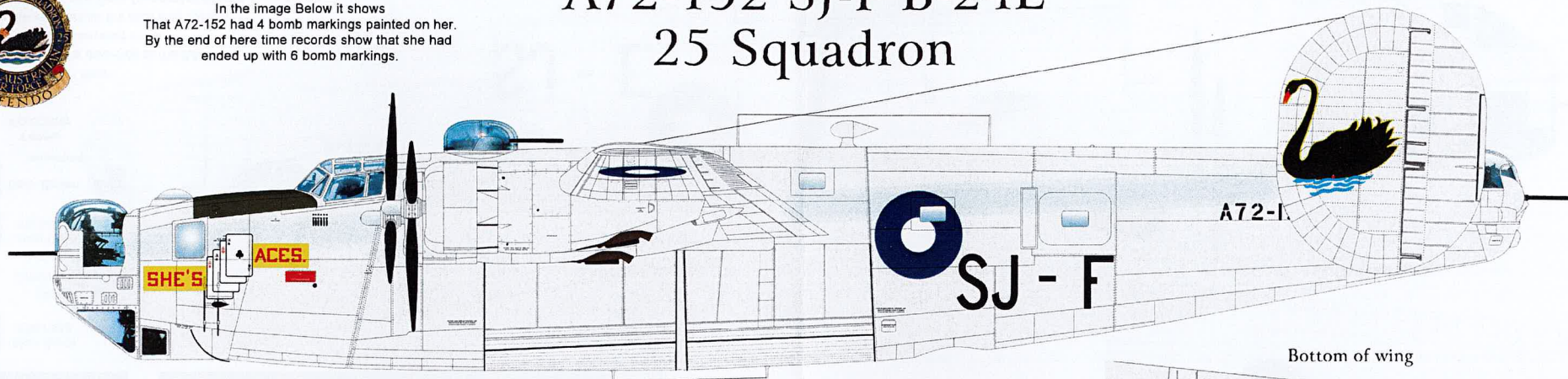

Bottom of wing

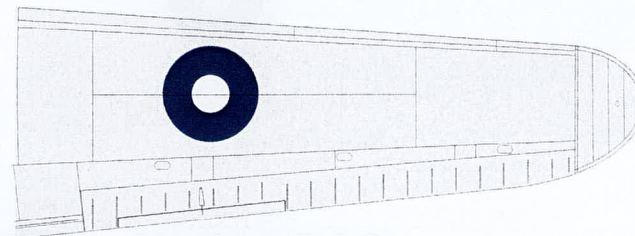
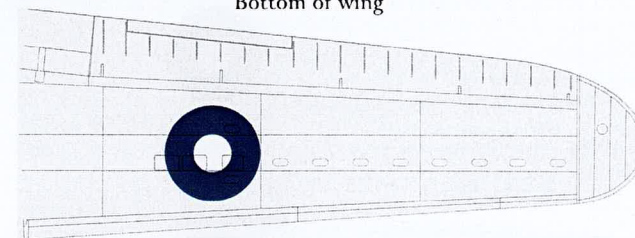

Top of wing

-  Matt Black  
FS27038
-  Overall  
Chrome Silver
-  Olive Drab  
FS34087
-  Dark Brown
-  Yellow  
FS-33538

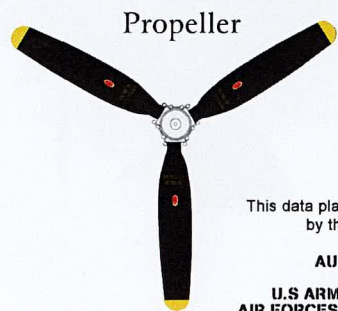

Propeller

Note:  
When these were delivered to the RAAF  
they were covered in data.  
As time went on, not all the data was applied.  
For Data Placement see Data Placement sheets.

This data plate was painted over  
by the Nose art.

**AUSTRALIA**

**U.S ARMY B-24L-5-C0**  
**AIR FORCES SERIAL 44-41518**  
SUITABLE FOR AROMATICS  
SERVICE THIS AIRCRAFT WITH 100  
OCTANE FUEL IF NOT AVAILBLE  
T.O.08-5-1 WILL BE CONSULTED  
FOR EMERGENCY ACTION

EXCEPT A.F.C.E



FRONT LEFT: PL BOB GREEN, W.A.C.; PL ARTHUR WHEELER; PL PATRICK BROWN; T/O. AL J. BURNETT, A.C.; PL FRANK WORTH; CAPTAIN FOR PATRICK, A.C.; PL ANDY LAYLA, W.A.C.; PL PAT WILSON, W.A.C.; W/O JIMMY BOWEN; CO-PILOT; W/O BILLY POOLE, W.A.C.; PL FRANK WORTH, W.A.C.

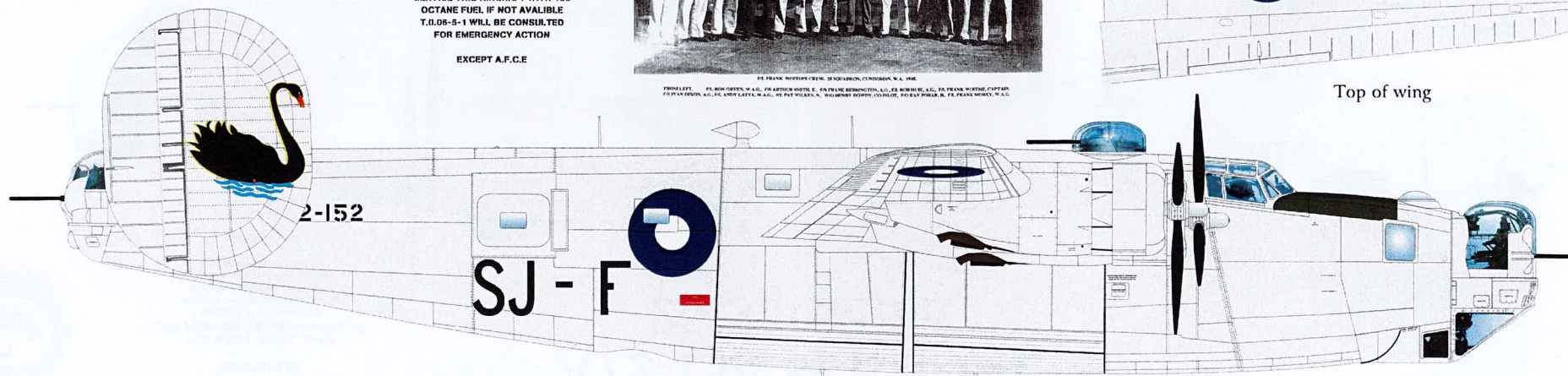



# Royal Australian Air Force

## A72-154 SJ-E B-24L

### 25 Squadron

AUSTRALIA  
 U.S. ARMY B-24L-5-CO  
 AIR FORCES SERIAL 44-41518  
 SUITABLE FOR AROMATICS  
 SERVICE THIS AIRCRAFT WITH 100  
 OCTANE FUEL IF NOT AVAILABLE  
 T.O.08-5-1 WILL BE CONSULTED  
 FOR EMERGENCY ACTION  
 EXCEPT A.F.C.E

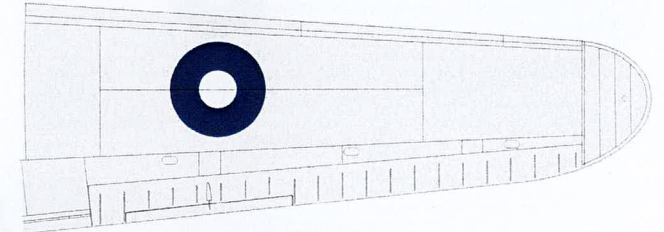
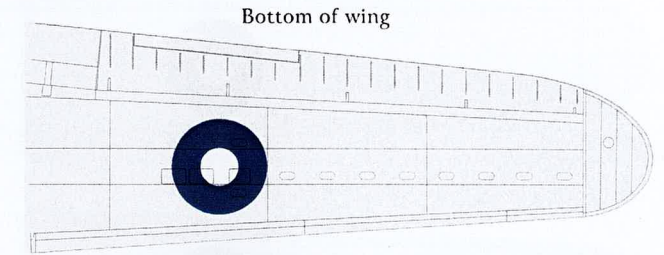
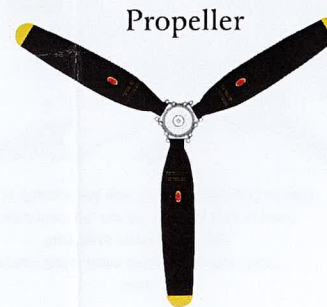
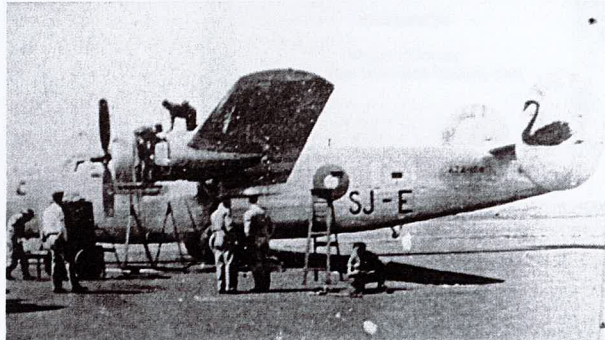
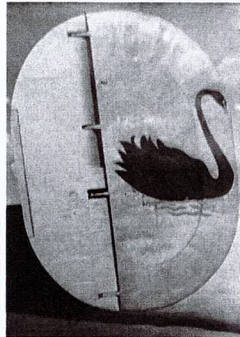
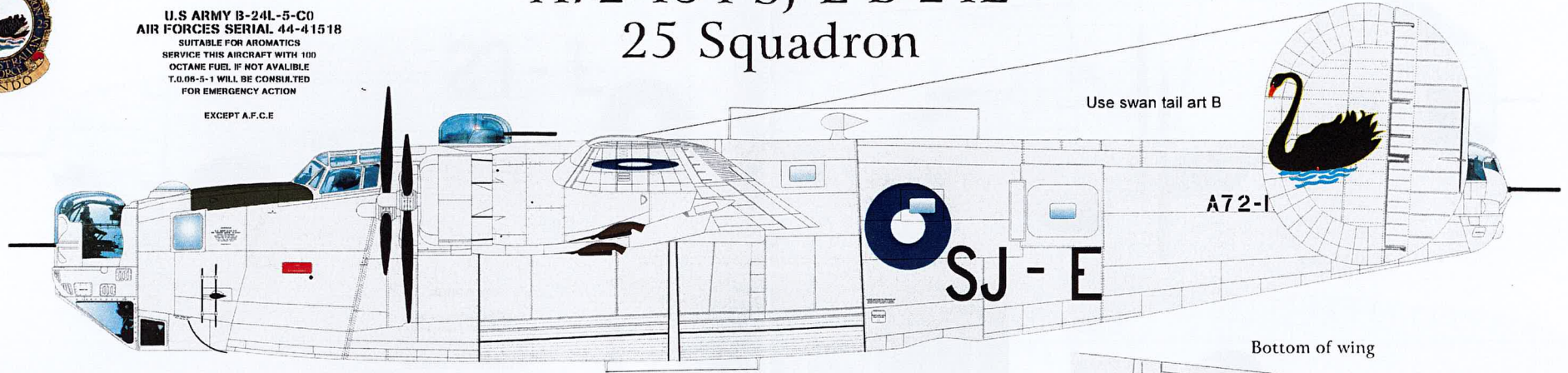

-  Matt Black  
FS27038
-  Overall  
Chrome Silver
-  Olive Drab  
FS34087
-  Dark Brown
-  Yellow  
FS-33538

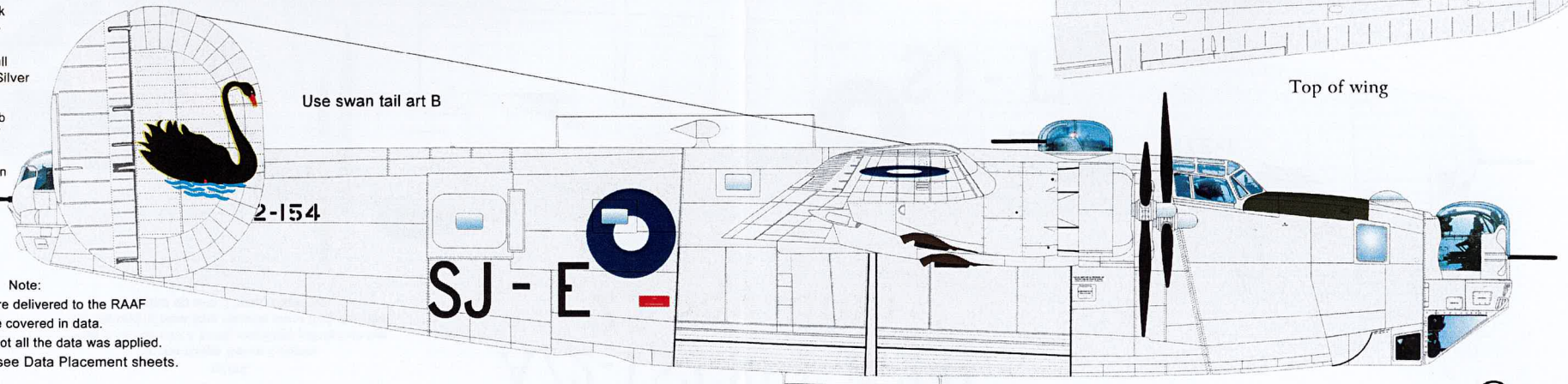

Note:  
 When these were delivered to the RAAF  
 they were covered in data.  
 As time went on, not all the data was applied.  
 For Data Placement see Data Placement sheets.

# Royal Australian Air Force B-24I/J/L/M Liberator's Data Placement

Early Days

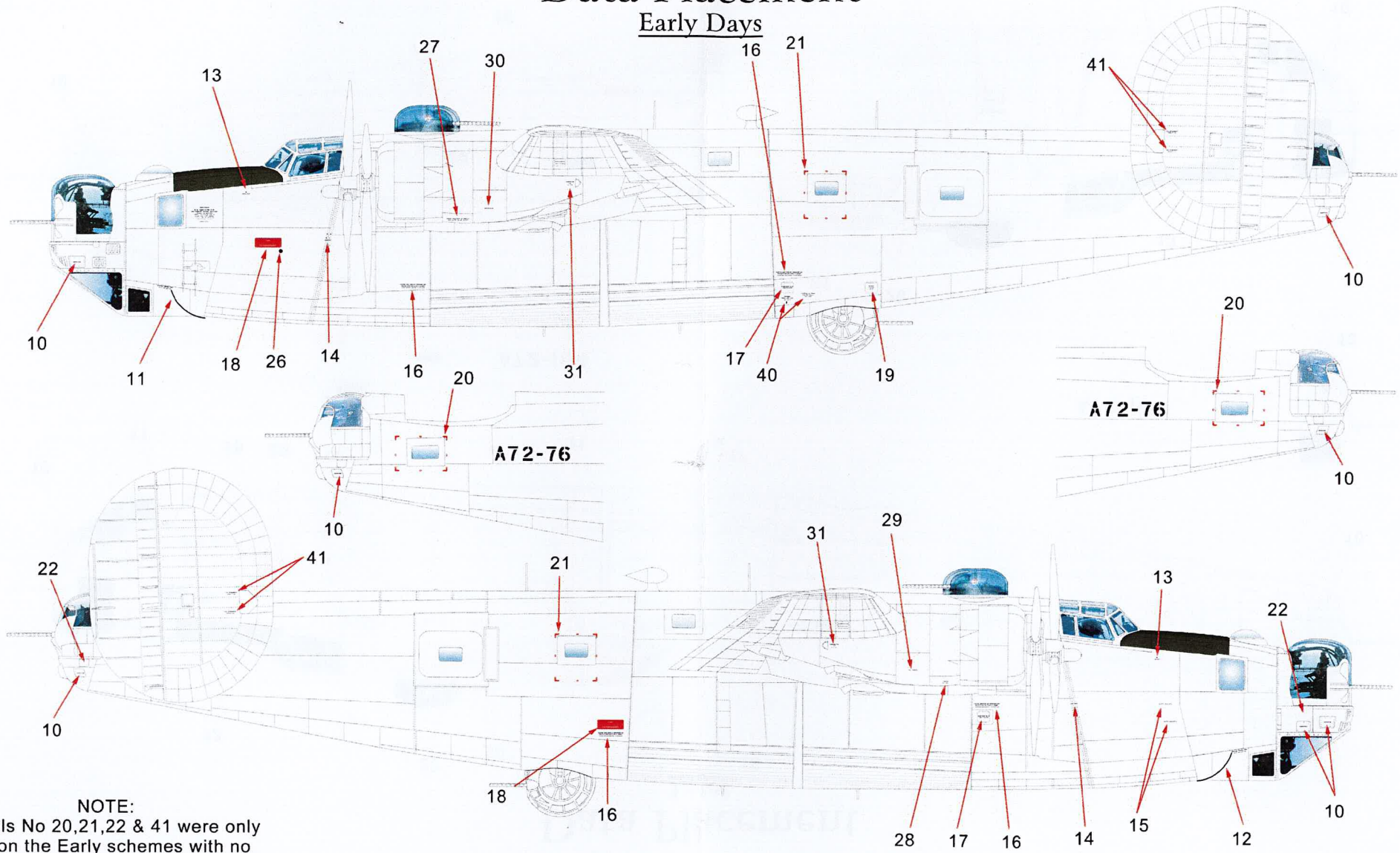

**NOTE:**  
Decals No 20,21,22 & 41 were only  
use on the Early schemes with no  
Swan on the tail.

# Royal Australian Air Force B-24I/J/L/M Liberator's Data Placement

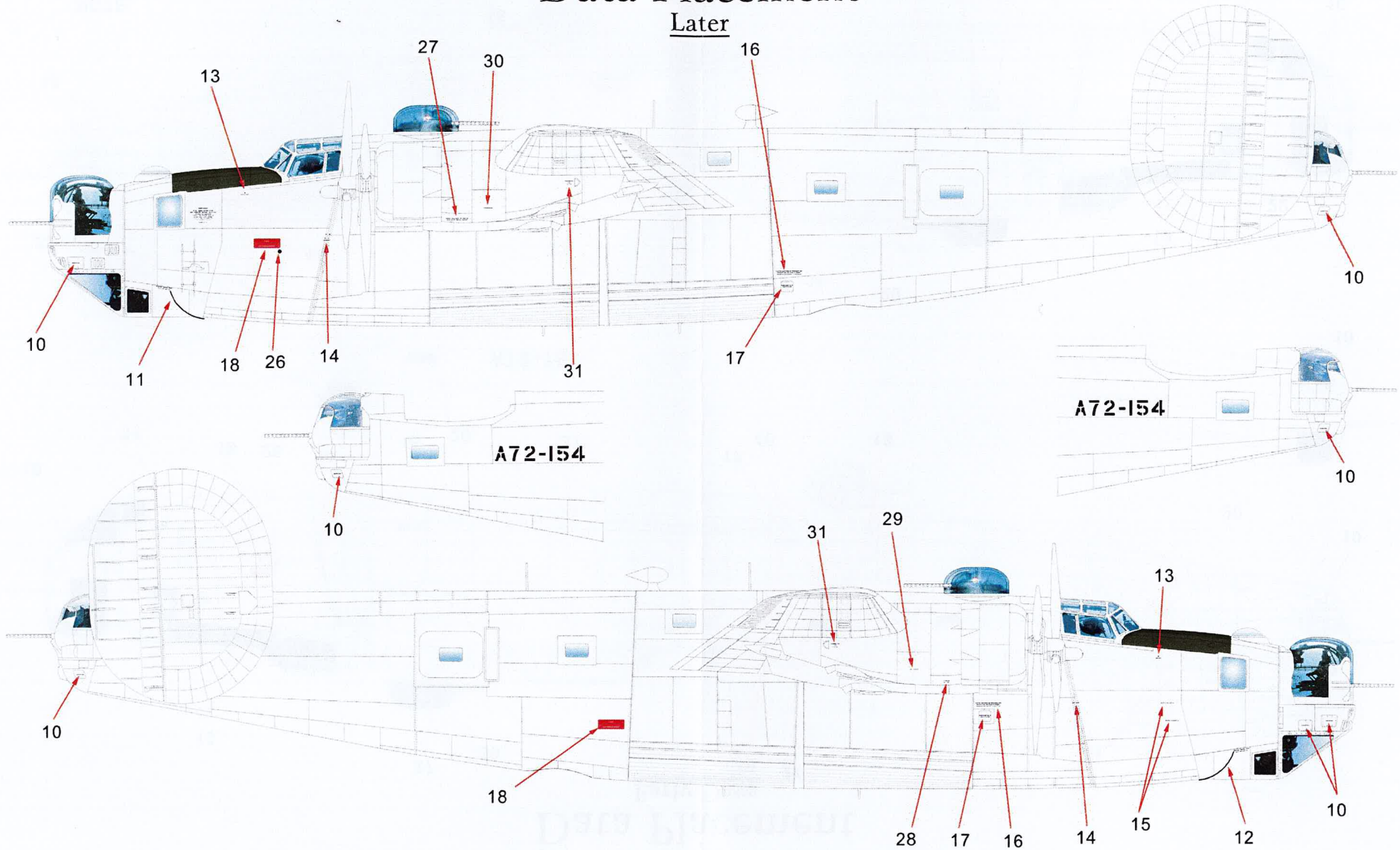

# Royal Australian Air Force B-24J/I/M Liberator Wing Data Placement

NOTE:2  
All Data goes in the same place  
on the starboard side wing.

Upper Port wing

Note 3  
Decals 28 & 29 go on inside of engine cells on the port wing  
and on the outside of the engine cells on the starboard wing.

Note 4  
Decals 27 & 30 go on outside of engine cells on the port wing  
and on the inside of the engine cells on the starboard wing.

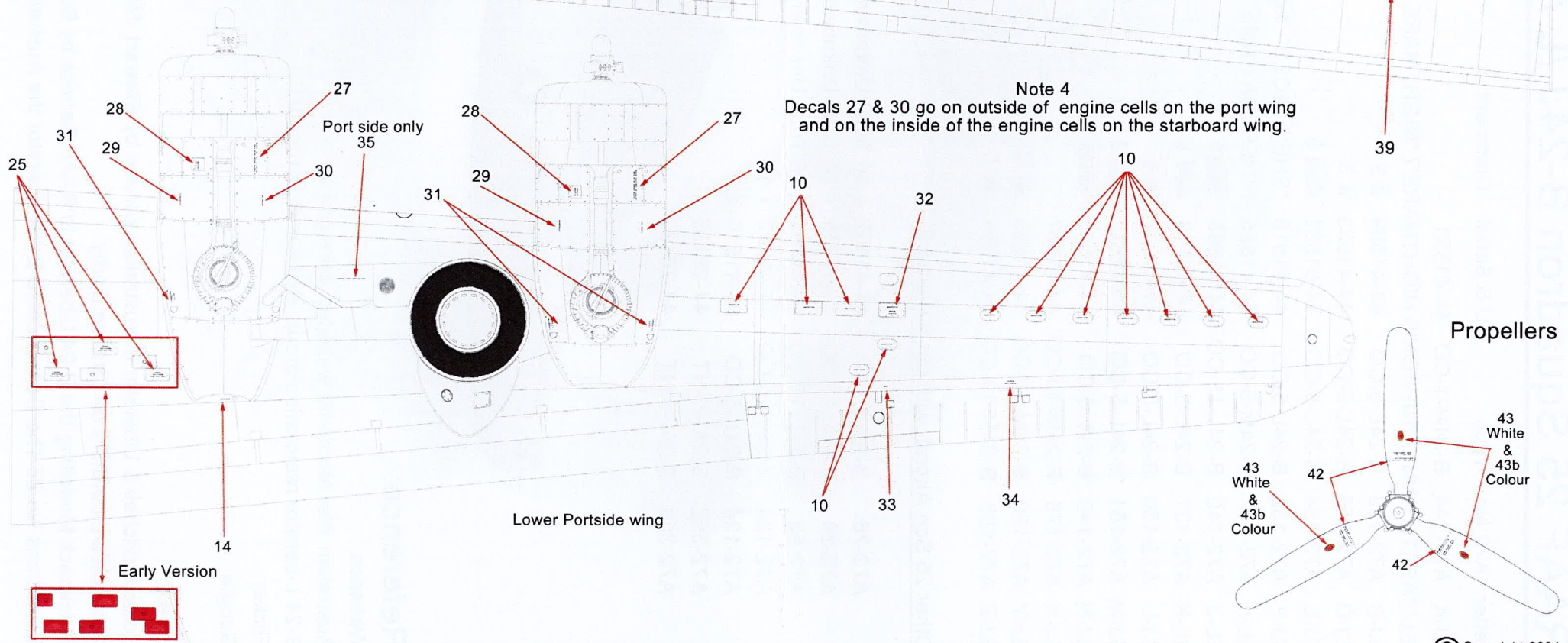

Early Version

23 / 24

Port side Starboard side

RDS-306 RAAF 25 Sqn B-24J/L/M Liberator

# RAAF 25 Squadron B-24J /L /M Aircraft serials

letter	A72 No	Type	U.S Serial	Comment
SJ-A	A72-144	B-24M-1-CO	44-41831	"ELIZABETH ANN" / "NIPPON'S NIGHTMARE" / "NIGHTMARE" / "NELLIES NIGHTMARE" / ■■■■■ 8
SJ-B	A72-133	B-24L-5-CO	44-41509	■■■ 3
SJ-D	A72-156	B-24L-5-CO	44-41533	■■■ 3
SJ-E	A72-154	B-24L-5-CO	44-51531	■■■■■ 9
SJ-F	A72-152	B-24L-5-CO	44-41518	"SHE'S ACES" ■■■■ 6
SL-H	A72-147	B-24M-5-CO	44-41885	"THERESA ANNE" ■■■■■ 9
SL-J	A72-140	B-24L-15-CO	44-41665	■■■■■ 9
SL-K	A72-137	B-24L-5-CO	44-41513	■■■■■ 8
SJ-L	A72-150	B-24L-5-CO	44-41516	■■■ 4
SJ-M	A72-151	B-24L-5-CO	44-41517	■■■■■ 9
SJ-N	A72-149	B-24L-5-CO	44-41515	■■■■■■■ 12
SJ-X	A72-178	B-24M-10-CO	44-41967	
SJ-Y	A72-190	B-24M-10-CO	44-41983	■■■ 4
SJ-Z	A72-165	B-24M-10-CO	44-41954	■■■ 5

## Other 25 Sqn Aircraft with out SJ- letters

A72-76	B-24I-1-CO	44-41402	i 36 Total Unknown with which Sqn
A72-89	B-24L-10-CO	44-41575	i 24 Total Unknown with which Sqn
A72-92	B-24L-10-CO	44-41581	i 25 Total Unknown with which Sqn
A72-124	B-24L-15-CO	44-41657	i 1
A72-134	B-24L-5-CO	44-41510	ii 2
A72-352	B-24J-5-NT	44-28135	
A72-353	B-24J-5-NT	44-28133	

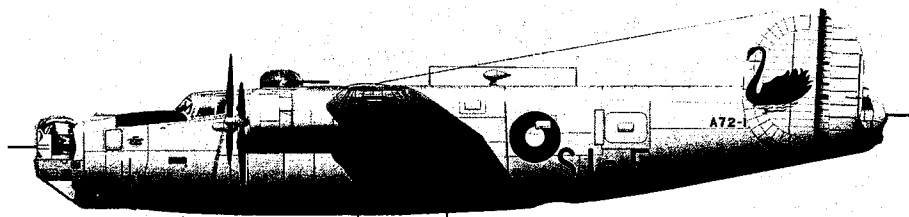

## Reference:

### Websites:

Australian War Memorial website: [awm.gov.au](http://awm.gov.au)

B-24 Liberator restoration group: [b24Australia.org.au](http://b24Australia.org.au)

Flicker.

Google

### Books:

Boston, Mitchell & Liberator in Australian service by Stewart Wilson

Australia's Liberators by Charles Darby

Strickback Modelling the B-24 Liberator in RAAF Service by Bob Livingstone

Squadrons No.28 The Consolidated B-24 Liberator the Australians by Phil h. Listemann



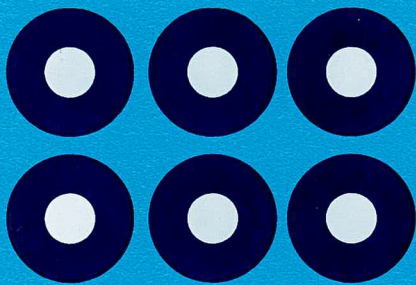

SJ - SJ -



PRINTED AND DESIGNED BY  
NORTH GROUPS AUSTRALIA  
AUSTRALIAN MADE AND OWNED  
Copyright 2024 ©



B

42



A

NELLIES NIGHTMARE

NIGHTMARE



SHE'S

ACES

A72-76 A72-89 A72-92 A72-124 A72-133 A72-134  
A72-76 A72-89 A72-92 A72-124 A72-133 A72-134

A72-137 A72-140 A72-144 A72-147 A72-149  
A72-137 A72-140 A72-144 A72-147 A72-149

A72-150 A72-151 A72-152 A72-153 A72-154  
A72-150 A72-151 A72-152 A72-153 A72-154

A72-156 A72-165 A72-178 A72-190 A72-352  
A72-156 A72-165 A72-178 A72-190 A72-352

A72-353 A-1234567890 A-1234567890  
A72-353 A-1234567890 A-1234567890

ABDEFHJKLMNXYZ  
ABDEFHJKLMNXYZ

RDS-306 RAAF 25 Sqn B-24J/L/M Liberators 1945 - 1946